



Integra[®] MicroFrance[®]

Integra ENT - Ear catalogue

Table of contents	ii	Small scissors, pointed blades, matt finish	26	Micro forceps with serrated jaws - Alligator forceps	44
Warranty and Customer Service Information	iv	Small scissors, blunt tip, matt finish	27	Alligator forceps	44
Indications / Contraindications	v	Metzenbaum scissors, small, matt finish	28	Micro forceps with serrated jaws	44
Diagnosis	2	Mayo scissors, matt finish	29	Micro scissors - Micro cup forceps	45
Angled stylet probe caustic holder	2	Fine dissecting forceps	30	Microcut forceps	46
Cotton carrier	2	Adson dissecting forceps	31	Micro piston forceps	47
Kidney bowl	4	with serrated jaws	31	Micro knife	48
Loop	3	with teeth	31	Micro chisel	48
Micro hook	2	Medium dissecting forceps	32	Micro double instrument	48
Myringoplasty	5 -6	Medium bipolar dissecting forceps	33	Micro Knife	48
Scalpel	7	Bipolar cables	33	Oval knife	48
Speculum	8-9	Forceps with serrated jaws	33	Sickle knife	48
Diagnosis speculum	8	Forceps with smooth jaws	33	Suction round knife	48
Dilator	9	Forceps with teeth	33	Micro mirror - Micro raspatory - Micro elevator	49
Self-retaining speculum	9	Medium monopolar dissecting forceps	34	Straight curette - Micro curette	50
Speculum with handle	9	Adson forceps	34	Micro double curette 155mm	50
Flexible tension arm	10	Forceps with serrated jaws	34	Micro angled curette 160mm	50
Diagnosis speculum	10	Forceps with smooth jaws	34	Micro angled double curette 155mm	50
Angled dissecting forcep	11	Forceps with teeth	34	Micro fenestrated curette 165mm	50
with serrated jaws	11	Monopolar cables	34	Micro straight curette 170mm	50
with spoon jaws	11	Tungsten needle-holder	35	Micro straight double curette 170mm	50
with teeth	11	Fine haemostatic forceps	36	Volkman straight curette 170mm	50
Syringe	12	Medium haemostatic forceps	37	Micro pick - Tenotome probe	51
Injection needles	12	Haemostatic forceps, serrated jaws	38	Micro hook	52
Pushing syringe	12	Towel clamp - Forceps with teeth	39	Miscellaneous micro hook - Micro raspatory	53
Replacement tube	12	Suction tube with finger control	40	Micro hook - Micro raspatory	53
Syringe luer-lock	12	Jankowski	40	Micro instrument, spoon handle	53
Washer for syringe	12	Lempert	40	Micro joint knife	53
Elevator - Raspatory	13	Suction irrigation tube with finger control	40	Micro raspatory	53
Curved raspatory	14	Wertheimer	40	Micro coagulation	54
Retractor	15 -16	Micro suction tube - Adapters	41	Bipolar cables	54
Curved self-retaining retractor	17	Micro suction tube with finger control	42	Bipolar forceps	54
Self-retaining retractor	18	Micro suction tube	43	Monopolar cables	54
Large self-retaining retractor	19	Angled suction with luer-lock	43	Monopolar curved elevator	54
Articulated self-retaining retractor	20	Blunt eyes suction tube	43	Monopolar pick	54
Mallet	21-22	Micro malleable suction tube	43	Micro measuring rod	55
Chisel - Gouge	23				
Rongeur	24				
Double-action rongeur	25				

Prosthesis placement	56	Otoneurosurgery	71-73
Cartilage cutting block	57	Ball seeker	73
Fascia press	57	Blunt eyes suction tube	71
Ossiculoplasty sizer	56	Curved elevator	73
Punch for silastic	56	Fenestrated curette	73
Replacement blade for cartilage cutting block	57	Hook	73
Schuknecht device	56	Knife	73
Wire guide	56	Micro forceps	72
Piston placement	58	Micro pick	73
Hand drill perforator	58	Micro scissors	72
Piston trimming gauge	58	Raspatory	73
Preparation glass plate	58	Self-retaining retractor	72
Teflon cutting block	58	Suction irrigation tube with finger control	71
Otoplasty - Suction foot switch - Holder	59	Suction tube with finger control	71
Cause set	60-61	Selesnick set	74-75
Marquet micro instruments	62	Bipolar forceps	75
Austin micro instruments	63	Cup forceps	74
Guilford-Wright, Shea micro instruments	64	Curette	74
Hough micro instruments	65	Curved self-retaining retractor	75
Jordan micro instruments	66	Elevator	74
Thomassin set	67-68	Hook	74
Angled suction tube	68	Knife	74
Cup forceps	68	Scissors	74
Double elevator	67	MicroFrance® drilling	76
Forceps, serrated jaws	68	6 sided burrs	76
Hook - Raspatory	67	Diamond burrs	76
Sterilization case	68	Diamond knife	76
Sterilization tray	68	Drill burr	76
Suction tube adapter	68	Perforer six sided burr	76
Presutti set for endoscopic surgery of the ear	69-70	Sterilization case	76
Alligator forceps	70	Sterilization tray	76
Curved curette double-ended	69	Tungsten helicoidal pear burr	76
Fascia press	70	Tungsten round burr	76
Lancet knife	69	Stainless steel cup, tray - Surgical instrument oil	77
Sterilization case	69	Cup	77
Sterilization tray	69	Sterilization tray	77
Suction tube elevator	69	Surgical instrument oil	77
Suction tube with finger control	70	Stainless steel sterilization tray and case	78
Wire crimper forceps	70	Numerical index	79
		Table for corresponding manufacturer part numbers	
		For information purposes only	85

Integra Limited Warranty

Please refer to the warranty included in the packaging of each product to know the applicable warranty.

Contacts Customer service:

International

+33 (0) 4 37 47 59 50
+33 (0) 4 37 47 59 25 (fax)
csemea@integralife.com

France

+33 (0) 4 37 47 59 10
+33 (0) 4 37 47 59 29 (Fax)
custservfrance@integralife.com

Belgium & Luxembourg

+32 (0) 2 257 4130
+32 (0) 2 253 2466 (Fax)
custsvcbenlux@integralife.com

United Kingdom

+44 (0) 1264 312 725
+44 (0) 1264 312 821 (Fax)
custsvcs.uk@integralife.com

Netherlands

+31(0) 852 083 167
+31(0) 207 093 627 (Fax)
custsvcnetherlands@integralife.com

Italy

+39 (0) 2 577 8921
+39 (0) 2 575 113 71 (Fax)
custsvcitaly@integralife.com

MicroFrance® ENT Instrumentation

INDICATIONS

- All the medical devices showed in this catalogue have indications for diagnosis and/or ENT surgery.
- Sizes are not contractual and are given for information purposes only.

CONTRAINDICATIONS

- Do not use in indications other than the indications mentioned in the DFU or Labeling.

How to read the catalogue

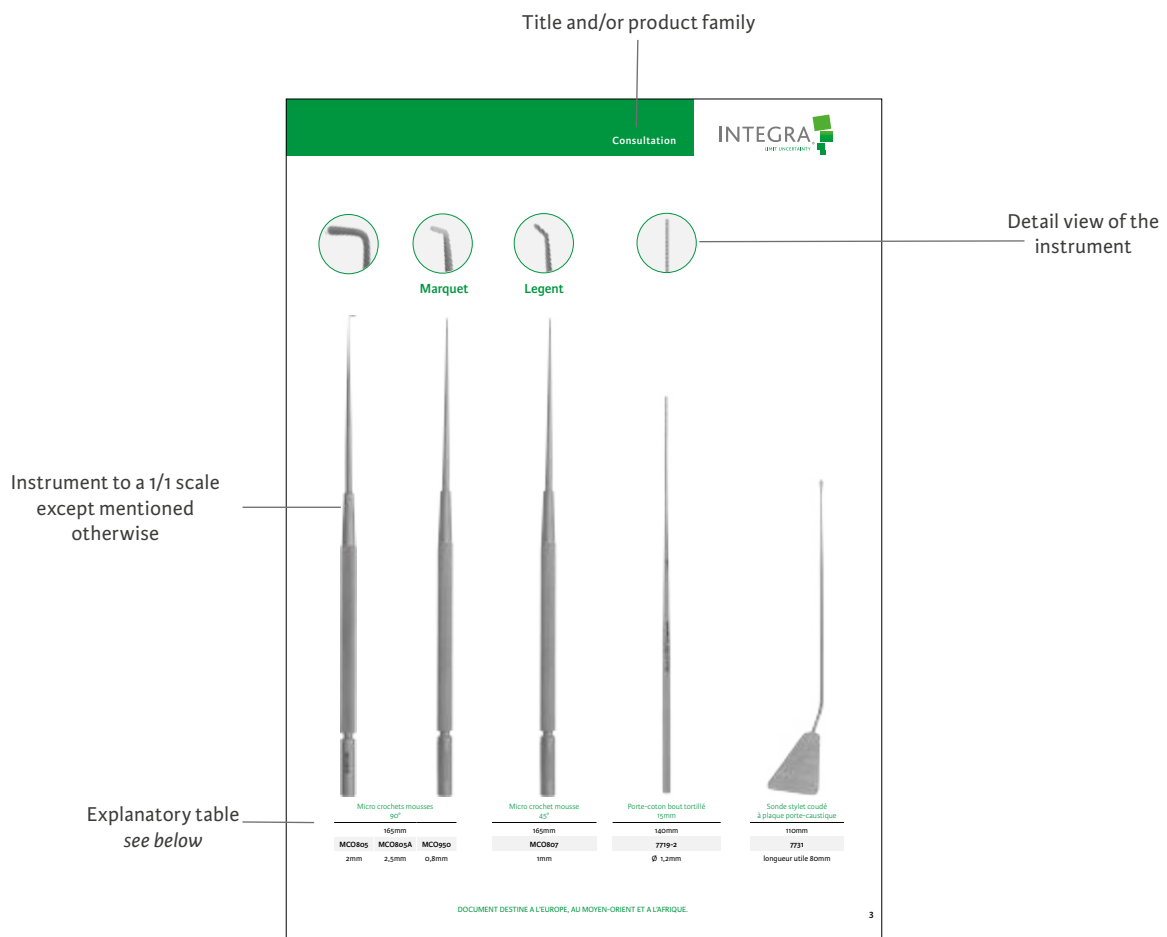

Explanation of the table reference and complementary product description

Title or subtitles	
Global complementary description	
Product ref.1	complementary description 1
Product ref.2	complementary description 2

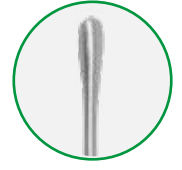
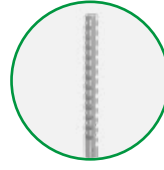
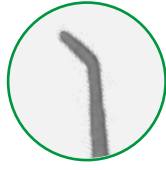

Marquet

Legent



Micro blunt hook
90°

Micro blunt hook
45°

Cotton carrier, twist end
15mm

Angled stylet probe
caustic holder

165mm

165mm

140mm

110mm

MCO805 **MCO805A** **MCO950**

MCO807

7719-2

7731

2mm 2.5mm 0.8mm

1mm

Ø 1.2mm

working length 80mm

Billeau



Snellen



Trautmann



Saint-Paul



Oval loop

160mm	140mm	200mm	170mm	90mm
7718	7885	7885A	7888	7886
4mm	4.5mm	4mm	4mm	2.5mm



Picture for information, without scale

Stainless steel kidney bowl

7875^(D)

^(D) Distributed by Integra MicroFrance SAS (France) - For corresponding manufacturer part numbers, see table in annex

“LU” Longueur utile

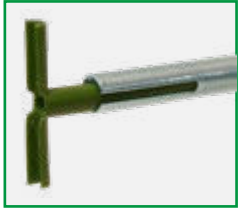

T-tube® 12mm inserter

MCO781
LU 95mm

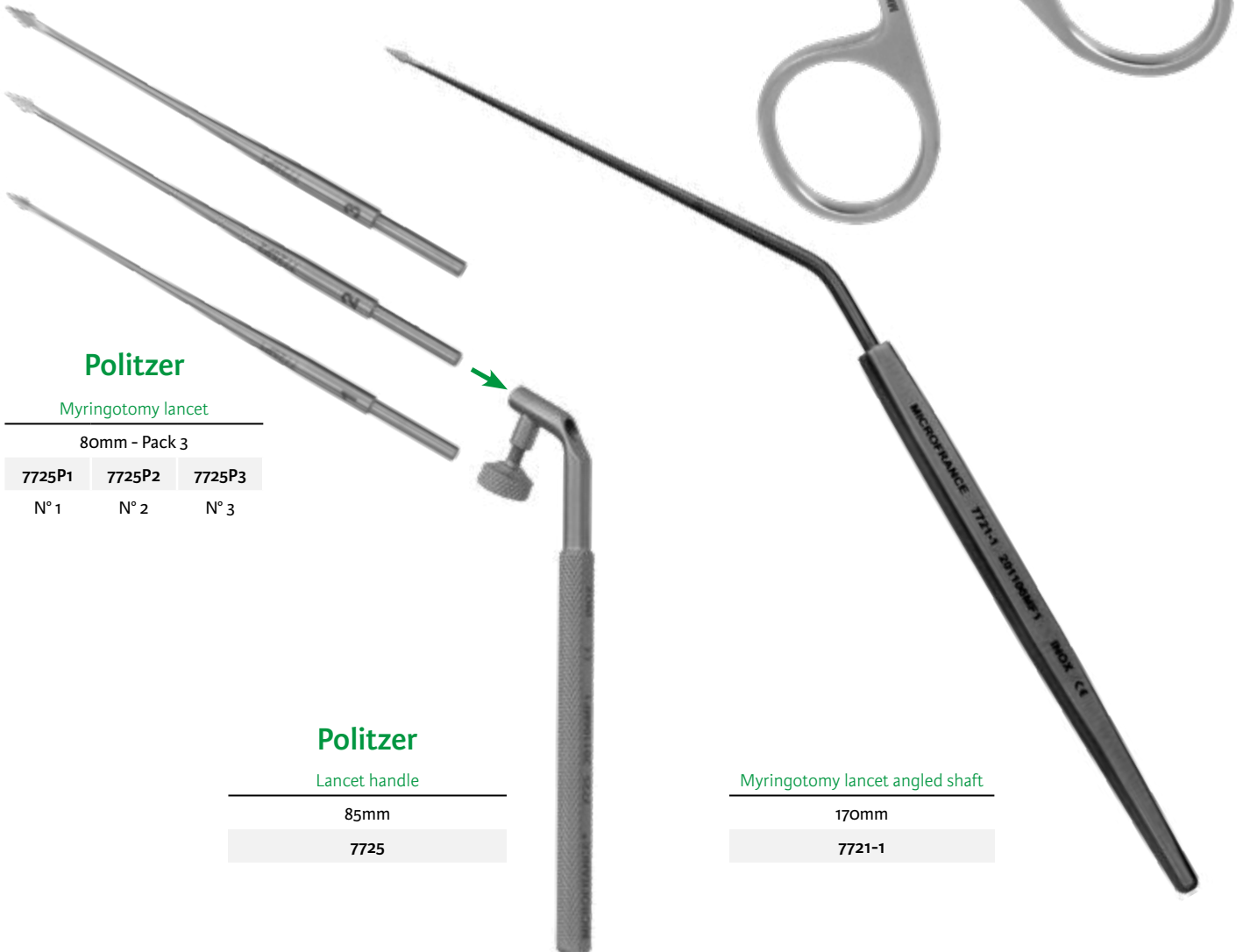

Politzer

Myringotomy lancet

80mm - Pack 3

7725P1	7725P2	7725P3
N° 1	N° 2	N° 3

Politzer

Lancet handle

85mm
7725

Myringotomy lancet angled shaft

170mm
7721-1



3722151

Myringoplasty double knife 2x3mm 165mm

3722150 90° et 115°
3722151 25° et 45°

Scalpel handle, non sterile



Knife blade, sterile, disposable, Pk 25



^(D) Distributed by Integra MicroFrance SAS (France) - For corresponding manufacturer part numbers, see table in annex
DOCUMENT FOR USE IN EUROPE, MIDDLE-EAST AND AFRICA ONLY.



120mm

160mm

200mm

150mm

120mm

1003IG^(D)

1005I^(D)

1003LI^(D)

CP821

1004IG^(D)

N° 3

N° 7

N° 3L

N° 4

use with blades 11/15

blades 23

^(D) Distributed by Integra MicroFrance SAS (France) - For corresponding manufacturer part numbers, see table in annex

Le Mée



45mm

Legent



40mm

Diameter	45mm	Pack 1, unit	Pack 1, unit	Pack 100, non sterile, individual packaging
○ 2mm	9913-1 ^(D)	-	-	-
○ 2,5mm	9913-2 ^(D)	-	-	-
○ 3mm	9913-3 ^(D)	8812-1	8814T1	
○ 4mm	9913-4 ^(D)	-	-	
○ 4,5mm	-	8812-2	8814T2	
○ 5mm	9913-5 ^(D)	8812-3	8814T3	
○ 5,5mm	-	8812-4	8814T4	
○ 6mm	9913-6 ^(D)	8812-5	8814T5	
○ 7mm	9912-7 ^(D)	-	-	
○ 8mm	9912-8 ^(D)	-	-	
○ 9mm	9912-9 ^(D)	-	-	

^(D) Distributed by Integra MicroFrance SAS (France) - For corresponding manufacturer part numbers, see table in annex



Hartmann

160mm

7898

Tieck-Halle



130mm

7897

Beckman



140mm

7899

Left hand

Vienna



140mm

MCO233

Dilator



140mm

MCO237

self-retaining
serrated blades

Tension arm



Legent

Flexible tension arm, complete

MCO980

delivered with MCO981



Darrouzet

Flexible tension arm

MCO978

delivered with MCO978S

Table clamp



CEV984

CEV985

Accessories for tension arm



Ear quick-lock speculum

MCO981



Articulated kneecap

MCO983-4



Devèze

Self-retaining speculum

MCO981D



MCO978S

Lucae



7726MF

150mm

7726MF	7727	7728
serrated jaws 1x12mm	spoon jaws	1x2 teeth

Politzer



7732-1

120mm

7732-1	7733	7734
serrated jaws 1,5x14mm	spoon jaws	1x2 teeth

Syringe luer-lock high pressure 5cc

Génia

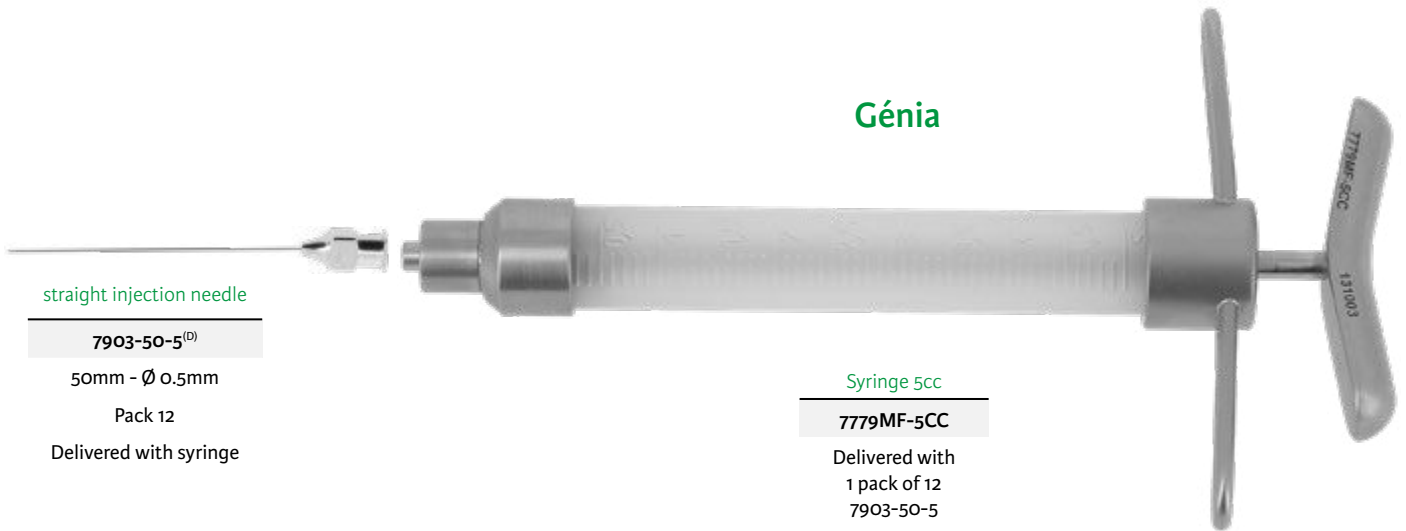

straight injection needle

7903-50-5^(D)

50mm - Ø 0.5mm

Pack 12

Delivered with syringe

Syringe 5cc

7779MF-5CC

Delivered with
1 pack of 12
7903-50-5



Silicone grey washer luer

7779MF-2

Pack 6



Replacement tube

7779MF-3



Silicon white washer piston

7779MF-1

Pack 6



Chouard

Pushing syringe

7783-12

Pack 2

for disposable syringe luer-lock 12cc

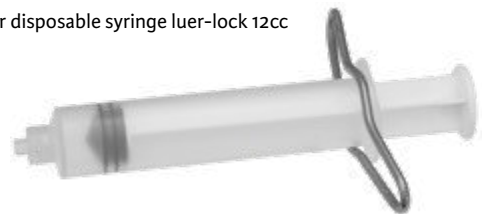

Injection needles

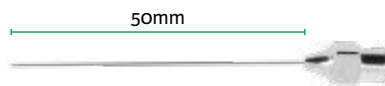

50mm

7903-50-5^(D)

Ø 0.5mm

Pack 12

for syringe 7779MF-5CC

^(D) Distributed by Integra MicroFrance SAS (France) - For corresponding manufacturer part numbers, see table in annex

Sébileau

Fleury

Freer

Howarth

Cottle

McKenty



190mm

CP985

5mm



180mm

MCO305

8.5mm



160mm

MCO803

2.5mm



185mm

CP611

5mm



220mm

CP625



220mm

CP626



240mm

CP627

Farabeuf

Fleury

Sébileau

Plester



150mm

7787-10

10mm



170mm

MCO979

6,5mm



150mm

CP825

4mm



180mm

MCO988

7,5mm



195mm

3724059

6,5mm

Farabeuf

Desmarres

Gillies

Gillies

Humby



120mm	140mm
7768	7768-1
Pack 2	Pack 2

140mm
CP822-12
12mm
CP822-10
10mm
CP822-14
14mm

180mm
CP17
3mm
CP17-1
2mm

145mm
CP17-3
2mm
CP17-2
3mm

145mm
CP628
5mm

110mm
CP941
articulated

Knapp



150mm

3714027

8mm

3714028

blunt

Volkmann



140mm

CP21-3

sharp

CP21A-3

blunt



150mm

7782-1-2

Senn-Miller



180mm

CP335



160mm

CP609

3 sharp prongs

Weitlaner

110mm

0-28-8



Schuknecht

130mm

0-28-2



Weitlaner-Wullstein

130mm

0-28-1



Weitlaner

130mm

0-28

3x4 sharp prongs

Self-retaining retractor with blade



Plester

110mm

o-28-3	o-28-4
sharp prongs right	sharp prongs left



Weitlaner

Curved retractor

160mm

0-28-7

sharp prongs

Bizeau

165mm

MCL359

3 blades 20x30mm



Weitlaner-Beckmann

165mm

7781



Lombard

165mm - 110g

MCO995



185mm - 330g

7766

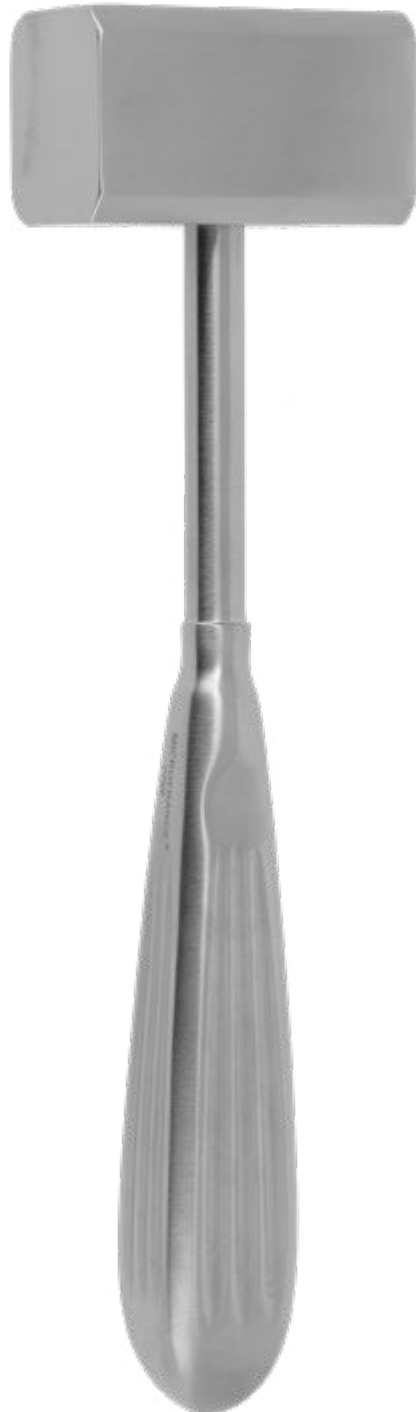

180mm - 200g

CP907

1 teflon head



180mm - 230g

CP300



Jost



180mm



CP801-7 7mm



CP801-10 10mm



150mm

CP823-5 5mm



150mm

CP824-5 5mm

Fleury



130mm



MCO214-13-10 1mm



MCO214-13-20 2mm



MCO214-13-40 4mm



MCO214-13-60 6mm



MCO214-13-80 8mm

Scale 1/2

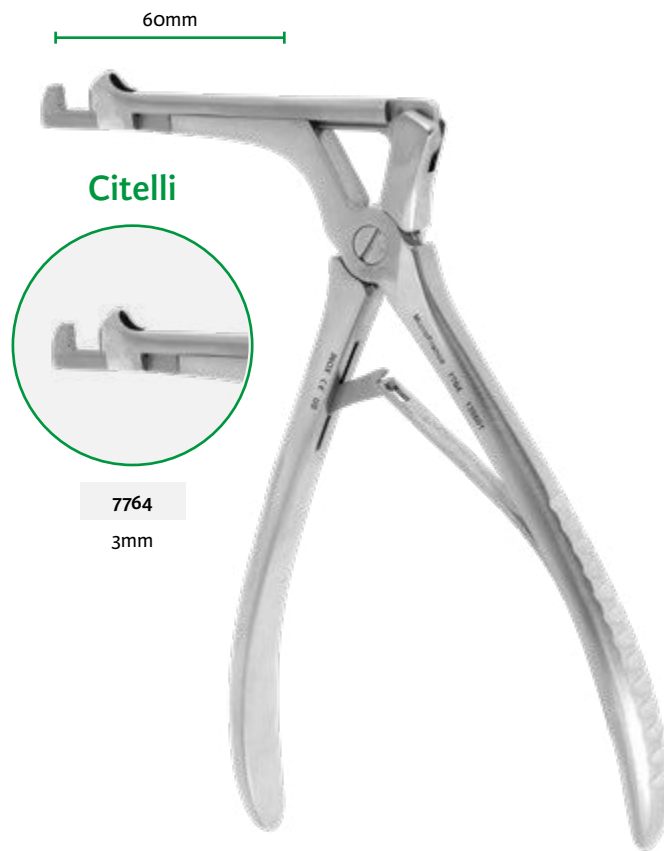



CP380

Beyer

160mm

CP380	CP380-2
straight jaws 2mm	curved jaws 2mm



CP380-3

Beyer

180mm

CP380-3	CP380-5	CP380-1
curved jaws 2mm	curved jaws 4mm	straight jaws 2mm

Streiff

105mm

CP16-1	CP16
curved blades	straight blades



100mm

CP353
strong curvature



Offret

100mm

CP356



Joseph

120mm

CP354A	CP354
curved blades	straight blades



Joseph

110mm

CP919A	CP919
curved blades	straight blades



Fox

110mm

CP358A	CP358
curved blades	straight blades



Shea

120mm

CP637

curved blades



Bregeat

110mm

CP363

curved blades



Stevens

110mm

CP922A

curved blades
Tenotomy

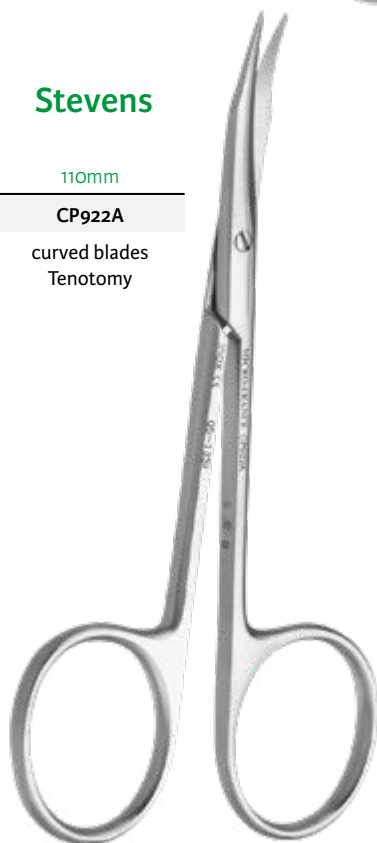

Stevens

110mm

CP922

straight blades
Tenotomy



Stevens

115mm

CP922B

curved blades
Tenotomy

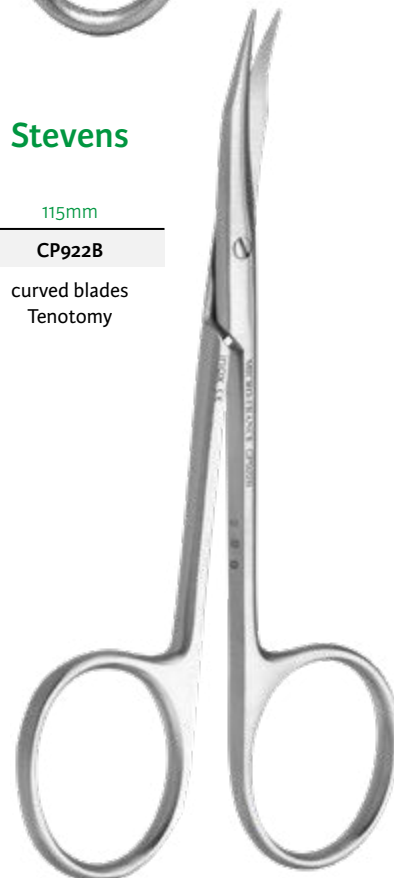

Metzenbaum

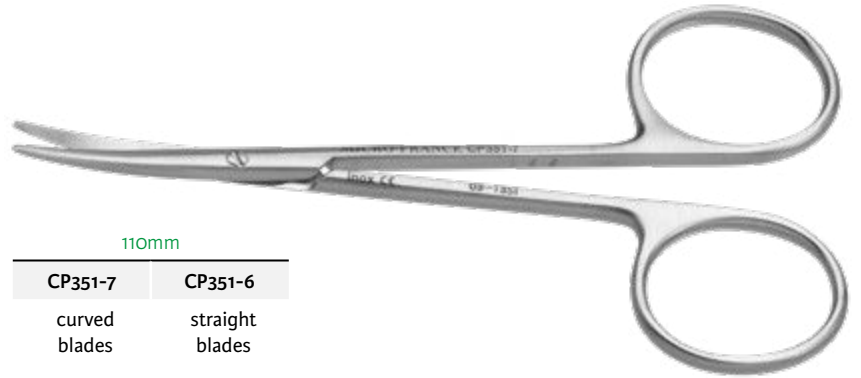

110mm

CP351-7	CP351-6
curved blades	straight blades

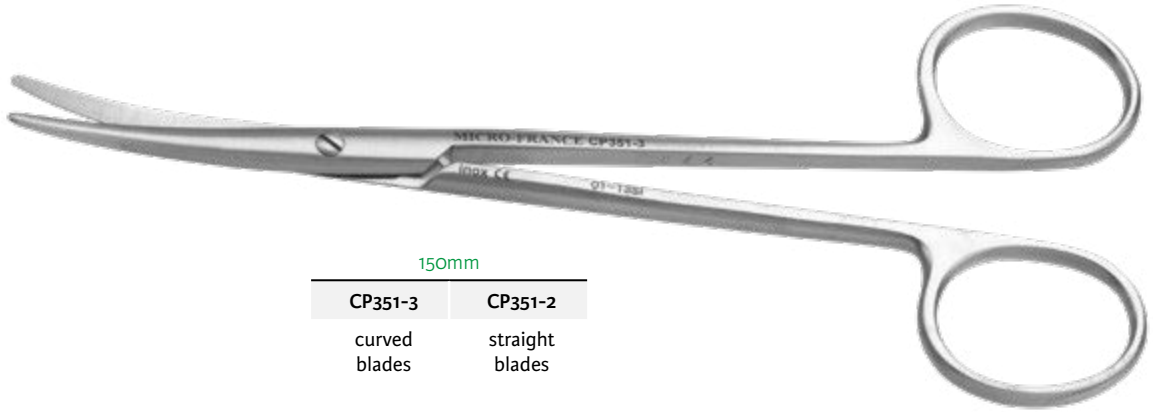

150mm

CP351-3	CP351-2
curved blades	straight blades

Delicate blades

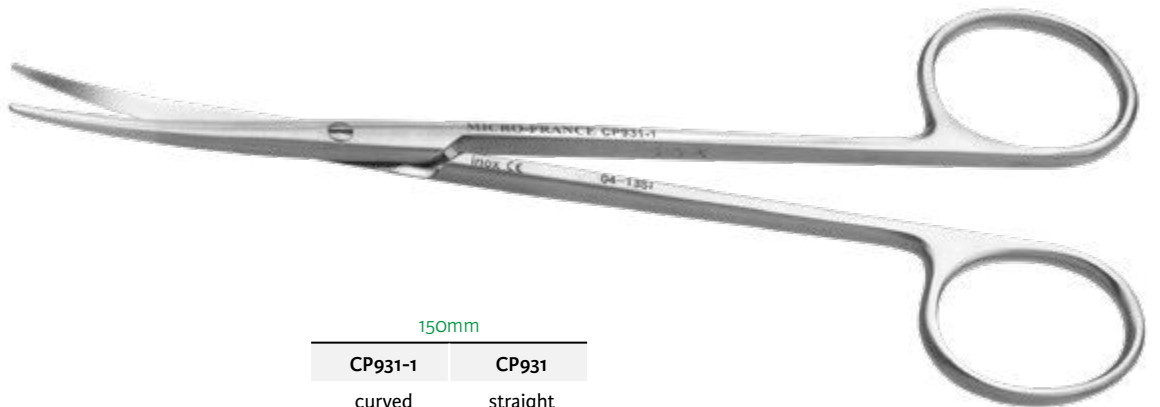

150mm

CP931-1	CP931
curved blades	straight blades

Mayo



170mm
CP352-2
straight blades

150mm
CP352
straight blades

170mm
CP352-3
curved blades

150mm
CP352-1
curved blades

Dissecting forceps 110mm

horizontal 1x2 teeth
and platform



CP938-1

Castroviejo

oblique 1X2 teeth
and platform



CP37

Castroviejo

crossed serrated
jaws 1.4mm



CP332

Dissecting forceps 120mm



serrated jaws

CP414

Jaws 1mm



7831A-12

Jaws 1.5mm



CP406

1x2 teeth - Jaws 1mm



7833A-12

1x2 teeth - Jaws 1.5mm



CP400-1

5x5 teeth

150mm

Adson



- CP604-15 serrated jaws 1.5mm
- CP605-15 1x2 teeth 1.5mm

Adson-Brown



- CP606-15 7x7 teeth

120mm



Adson-Tubiana

Adson

Adson-Brown

Jaws 1mm		Jaws 1,5mm		Jaws 1,5mm	7x7 teeth
M832	M833	CP604	CP605	CP606A	CP606
serrated	1x2 teeth	serrated	1x2 teeth	serrated tungsten jaws	

Mac-Indoe

140mm



CP934 oblique
1x2 teeth
and serrated
platform

CP934-1 serrated
jaws

Debakey

Barraya

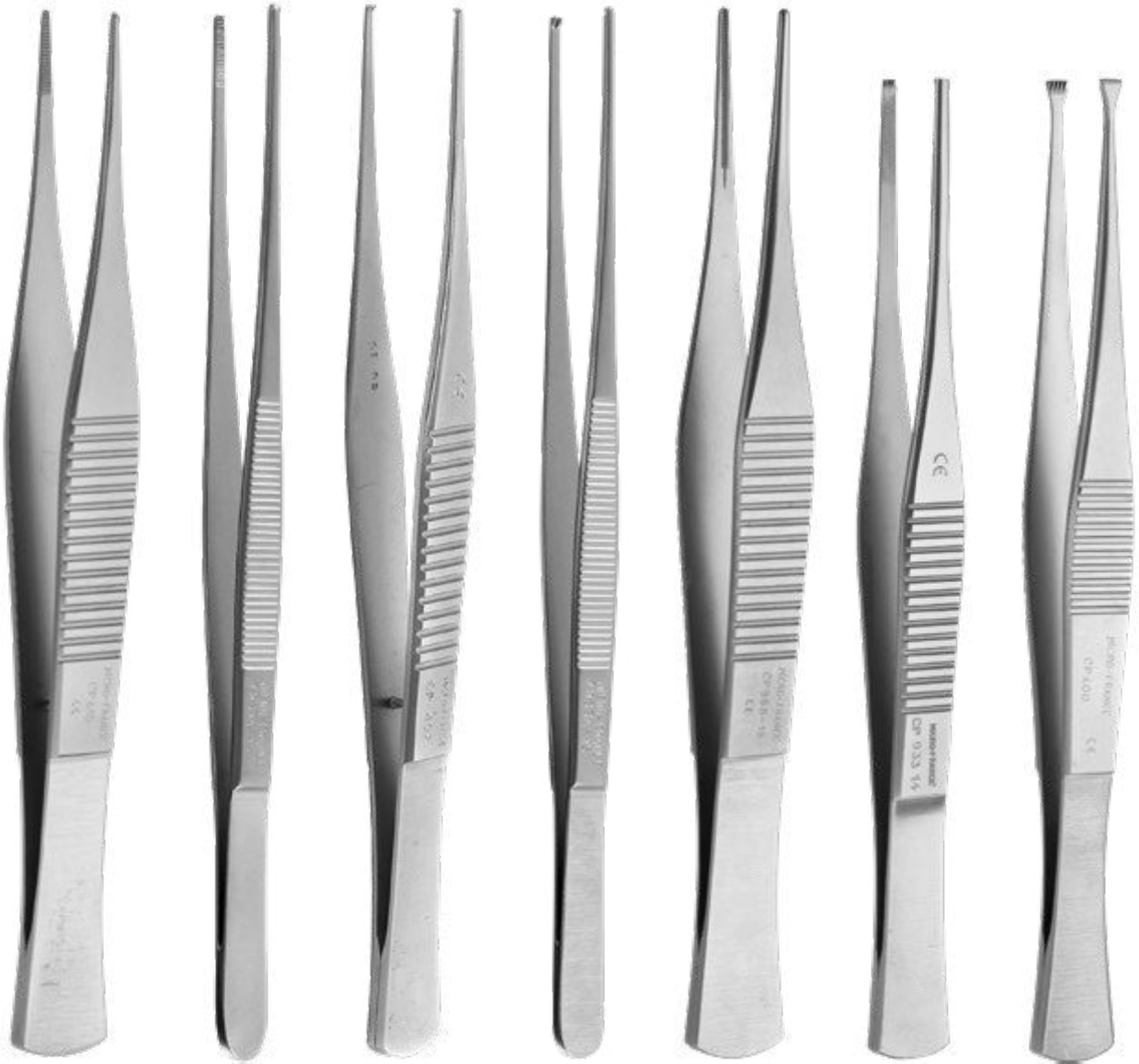

150mm

140mm

CP415	7831A-15	CP407	7833A-15	CP988-15	CP933-14	CP400
serrated jaws 1mm	serrated jaws 1.5mm	1x2 teeth jaws 1mm	1x2 teeth jaws 1.5mm	jaws 1.5mm	3x4 teeth and serrated platform	5x5 teeth

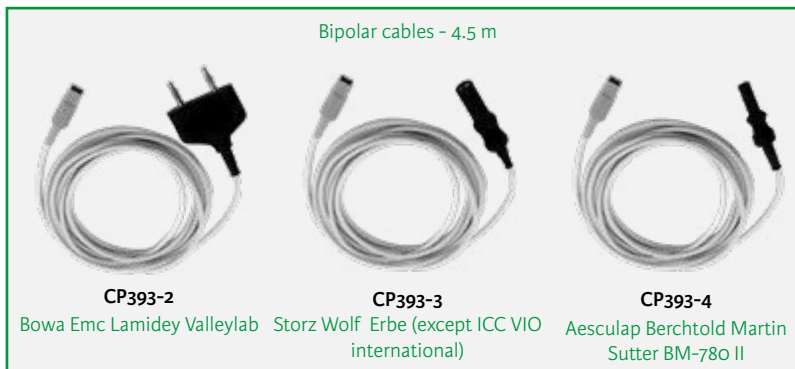

Magnan



Adson



110mm		120mm		160mm		200mm	
CP392-1R	CP604BR	CP605BR	CP392-2R	CP392-8R	CP392BI	CP392BS	
Smooth jaws 1x8mm	Serrated jaws 1.5mm	1x2 teeth 1.5mm	Smooth jaws 1x8mm	Smooth jaws 1x8mm	Smooth jaws 0.5x5mm	Smooth jaws 0.5x5mm	

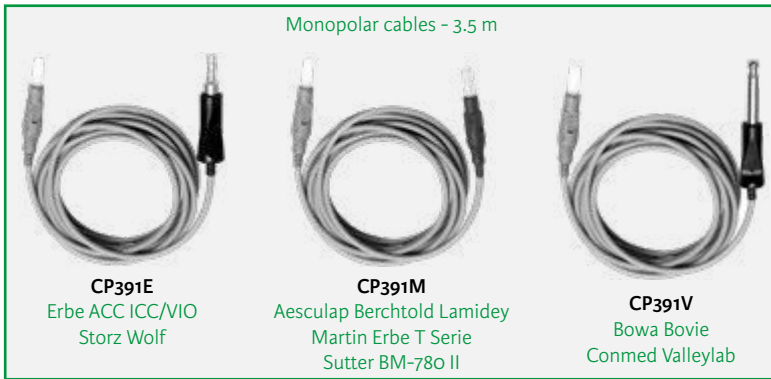

Adson



110mm

CP390-1
Smooth jaws
1x8mm



120mm

CP604M
Serrated jaws
1.5mm



CP605M
1x2 teeth
1.5mm



160mm

CP390-2
Smooth jaws
1x8mm



CP390-8
1x2 teeth
1x8mm

Halsey

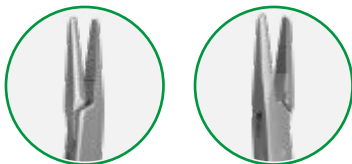

130mm

703T	704T
Serrated jaws	Smooth jaws

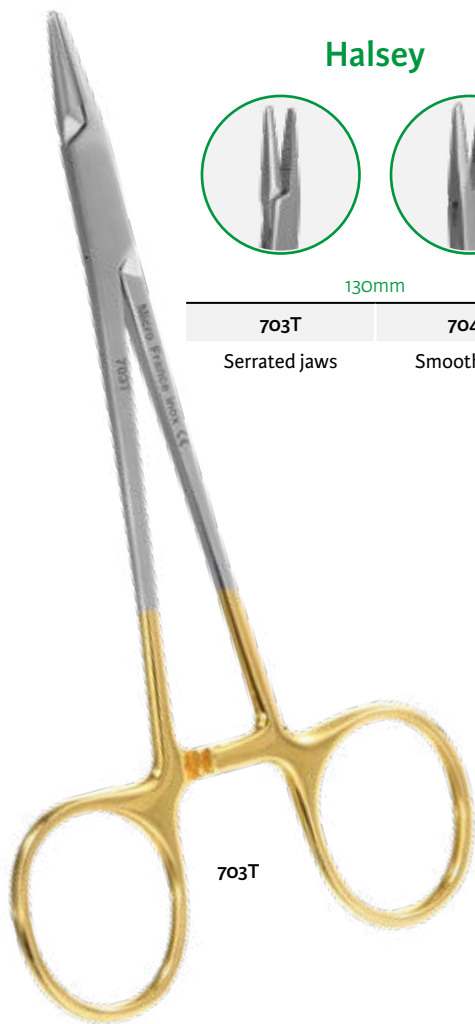

703T

Crile-Wood Mayo-Hégar



150mm

702T	714T
------	------

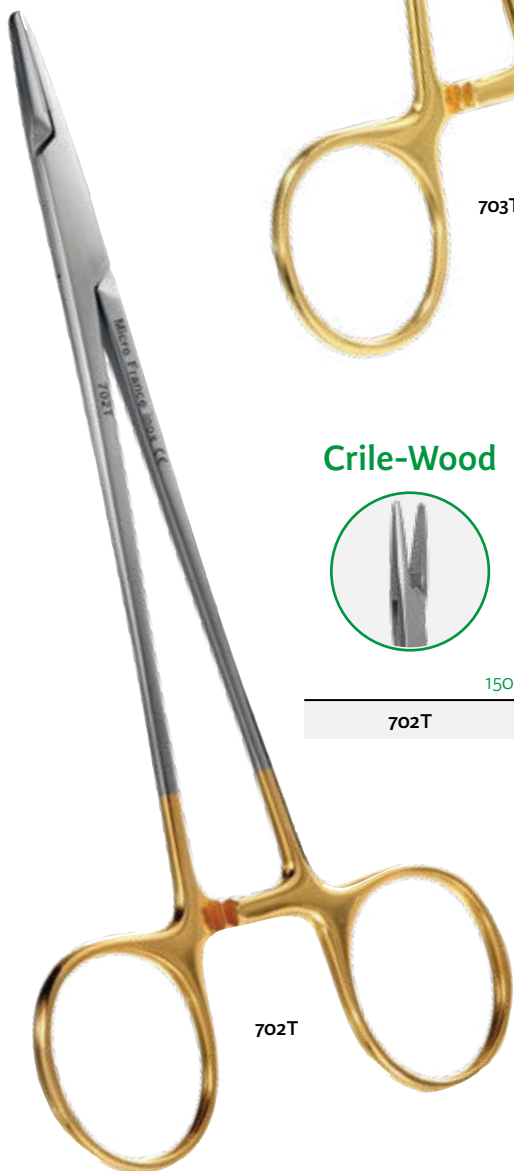

702T

Becker

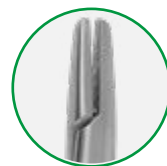

130mm

CP1107
diamond jaws

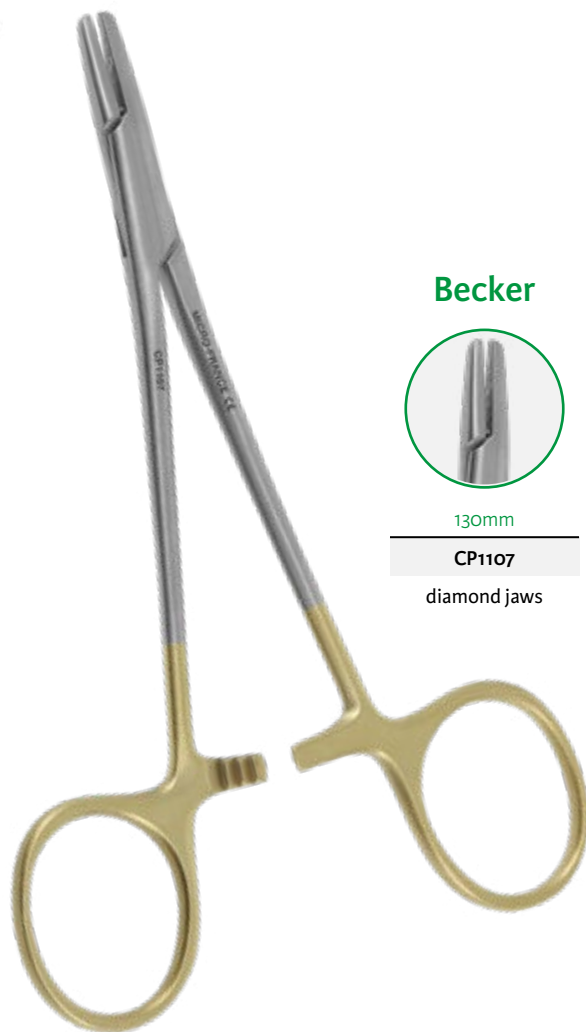

Leriche

140mm - without teeth

7867-1	7867-2
straight	curved

140mm - with teeth

7867-3	7867-4
straight	curved

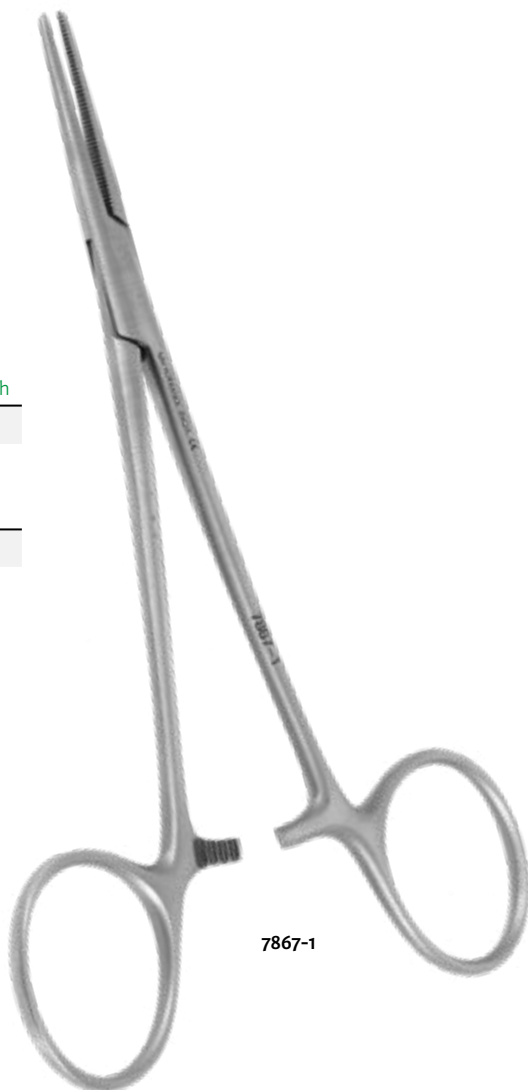

7867-1

Halsted

120mm - with teeth

P761-7	P761-8
straight	curved

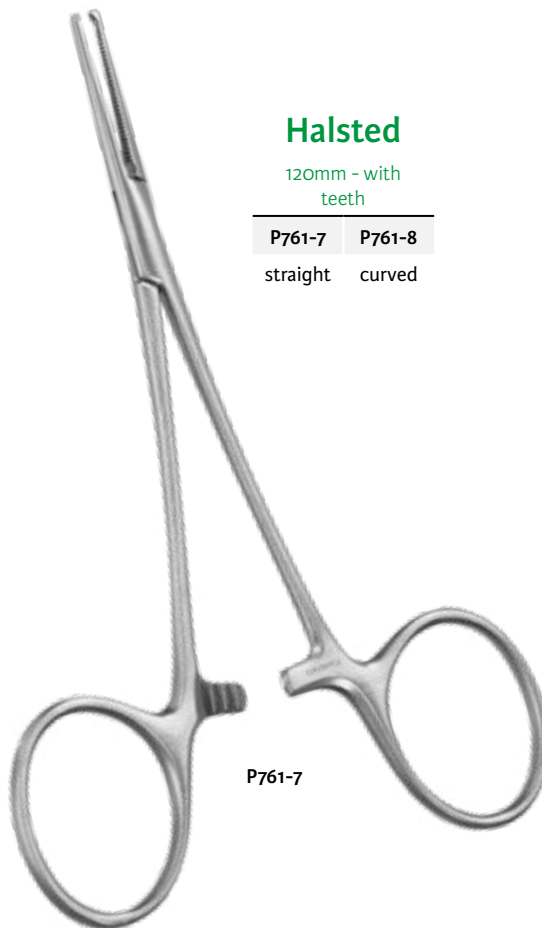

P761-7

Kelly

without teeth

140mm 160mm

P762-2 P762-4

curved curved



P762-2

Kocher

140mm 160mm 180mm

straight without teeth

P764-1 P764-5 -

straight with teeth

P764-3 P764-7 P764-11



P764-3



Martel

130mm

P763

Forceps with teeth
'T' tip



Péan

140mm 160mm

P765-14 P765-16

Haemostatic forceps
serrated jaws

P765-14



Terrier

130mm

P769

Haemostatic forceps
serrated jaws



Chaput

130mm

7866-13

2x3
teeth

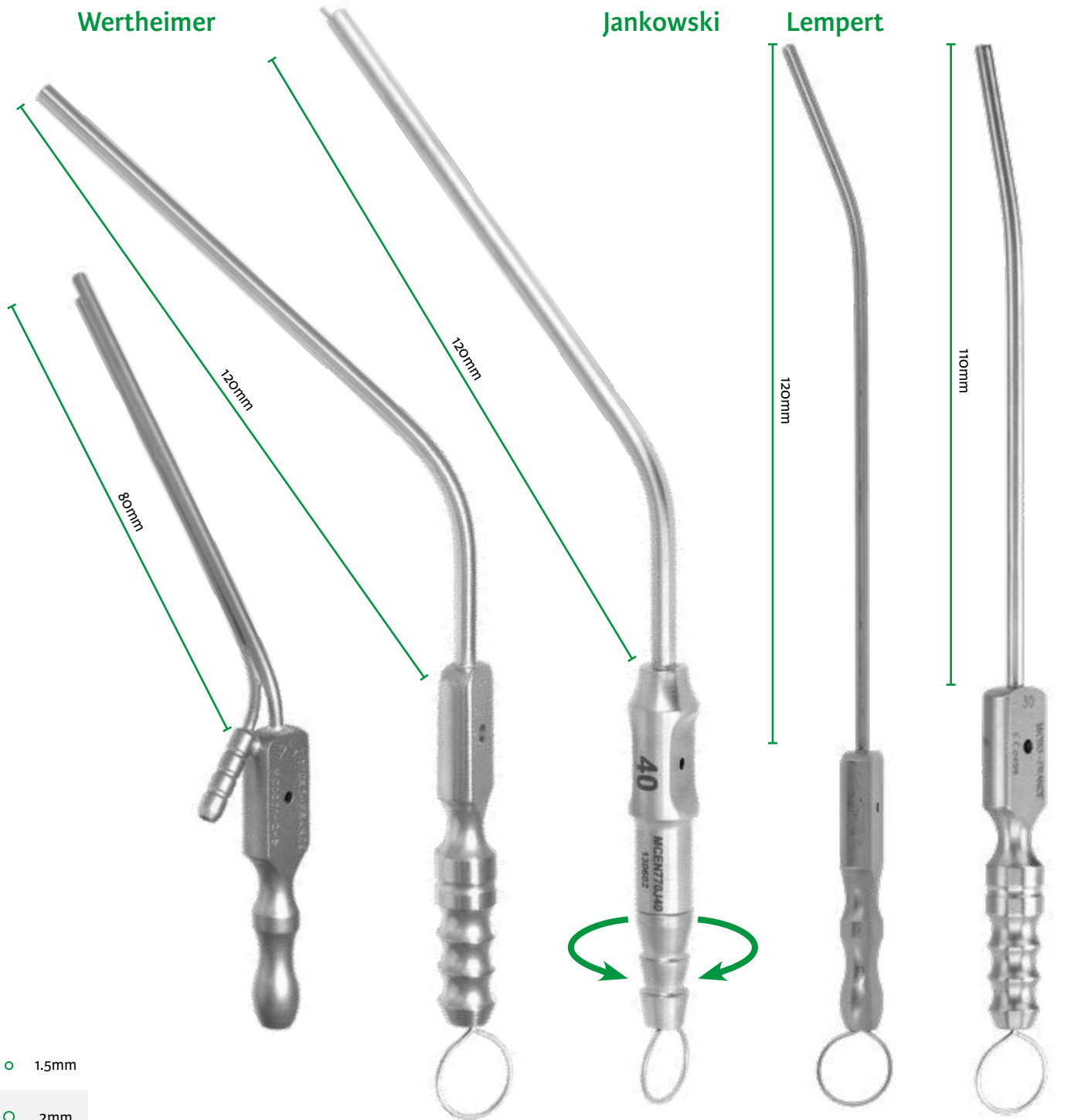

○ 1.5mm

○ 2mm

○ 2.5mm

○ 3mm

○ 3.5mm

○ 4mm

MCO201-2-5	2.5mm
MCO201-3-0	3mm

Wertheimer	
MCO770-1-5	1.5mm
MCO770-2-0	2mm
MCO770-2-5	2.5mm
MCO770-3-0	3mm
MCO770-3-5	3.5mm
MCO770-4-0	4mm

Jankowski	
MCEN770J40	4mm
MCEN770J30	3mm

Lempert	
MCO771-2-5	2.5mm
MCO771-3-0	3mm
MCO771-4-0	4mm

CP330-3-0	3mm
CP330-4-0	4mm

Luer-lock adapter

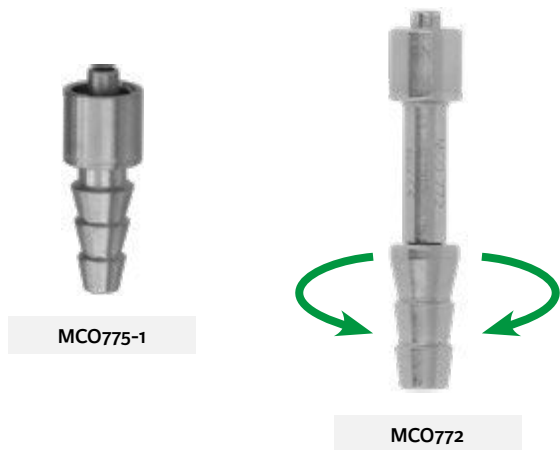

Suction tube adapter with finger control



Benzeth



Micro curved suction tube

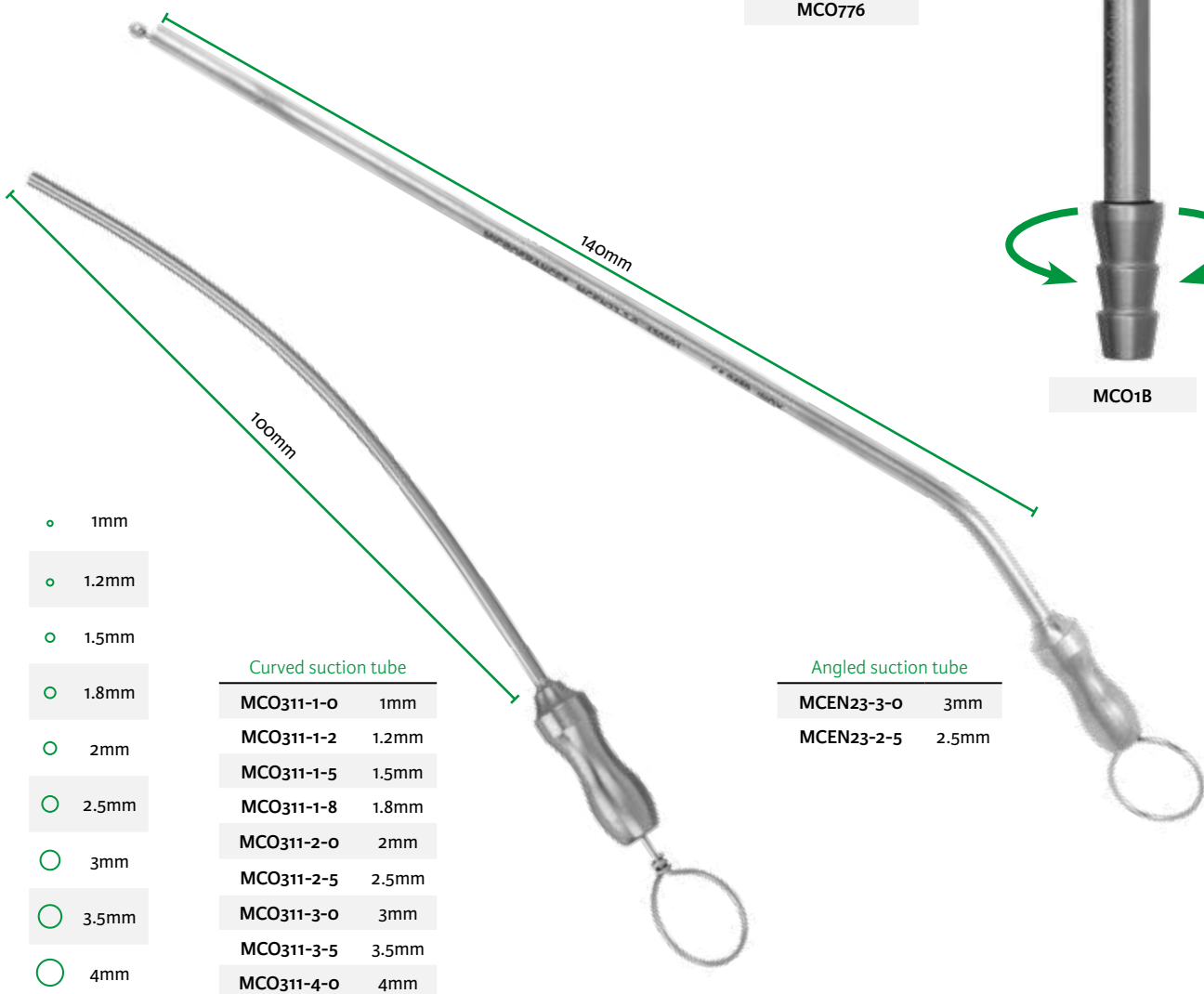

- 1mm
- 1.2mm
- 1.5mm
- 1.8mm
- 2mm
- 2.5mm
- 3mm
- 3.5mm
- 4mm

Curved suction tube

MCO311-1-0	1mm
MCO311-1-2	1.2mm
MCO311-1-5	1.5mm
MCO311-1-8	1.8mm
MCO311-2-0	2mm
MCO311-2-5	2.5mm
MCO311-3-0	3mm
MCO311-3-5	3.5mm
MCO311-4-0	4mm

Angled suction tube

MCEN23-3-0	3mm
MCEN23-2-5	2.5mm

Maspetiol



MCO773

Micro suction tube Ø 2,5 mm

MCO773

with luer-lock connection

Micro suction tube tip
for MCO773

MCO774-0-4	0,4mm
MCO774-0-5	0,5mm
MCO774-0-6	0,6mm
MCO774D8	0,8mm

Charachon



MCO890

Micro suction tube Ø 3mm

MCO890

Micro suction tube tip

MCO890-1-04	0,4mm
MCO890-1-08	0,8mm
MCO890-1-12	1,2mm
MCO890-1-15	1,5mm
MCO890-1-20	2mm

Rosen

Frayse

Causse

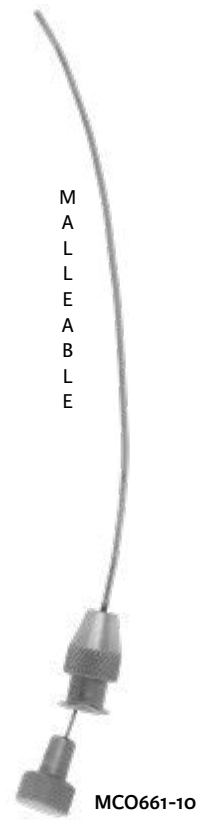

Micro angled suction tube with luer-lock

Micro blunt eyes suction tube with luer-lock

Micro malleable suction tube with luer-lock

Pack 3	
MCO3P05	0.5mm
MCO3P07	0.7mm
MCO3P10	1mm
MCO3P12	1.2mm
MCO3P15	1.5mm
MCO3P18	1.8mm
MCO3P20	2mm
MCO3P24	2.4mm

MCO366F10	1mm
MCO366F12	1.2mm
MCO366F15	1.5mm
MCO366F20	2mm

MCO661-10	1mm
MCO661-7	0.7mm

Hartmann

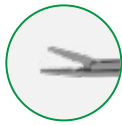

MCO13C
0.6x3mm



MCO13A
4.5x1mm



MCO17
4x0.8mm
Right opening



MCO13D
6x1.3mm



MCO22
6x1.5mm
1x2 teeth



MCO13B
8x1.6mm



MCO13E
0.9x12mm

70mm

Marquet



MCO960
0.6x3mm

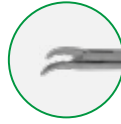

MCO961
0.6x3mm

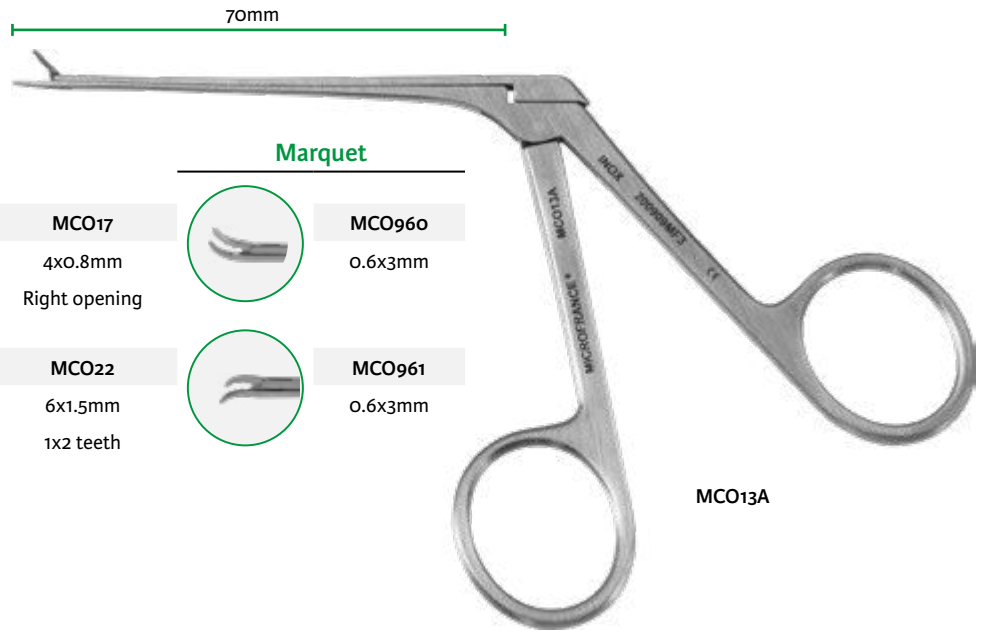

MCO13A

Alligator forceps

100mm

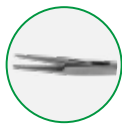

Martin
MCO23A
1.5x8mm

80mm

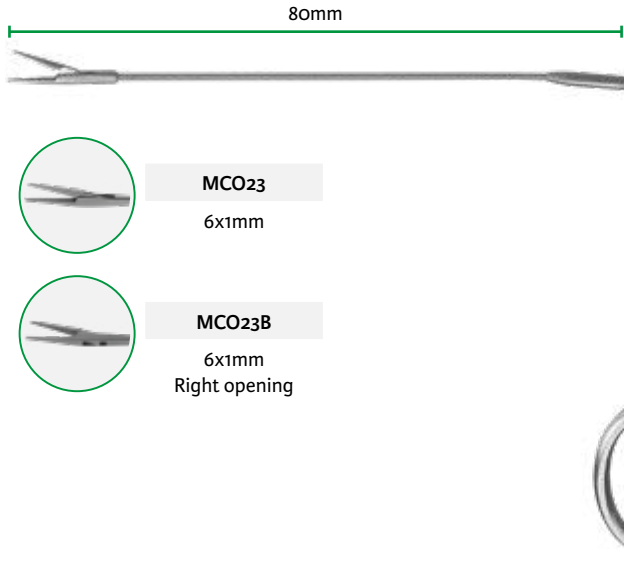

MCO23
6x1mm



MCO23B
6x1mm
Right opening

MCO23A

MCO23

Micro scissors

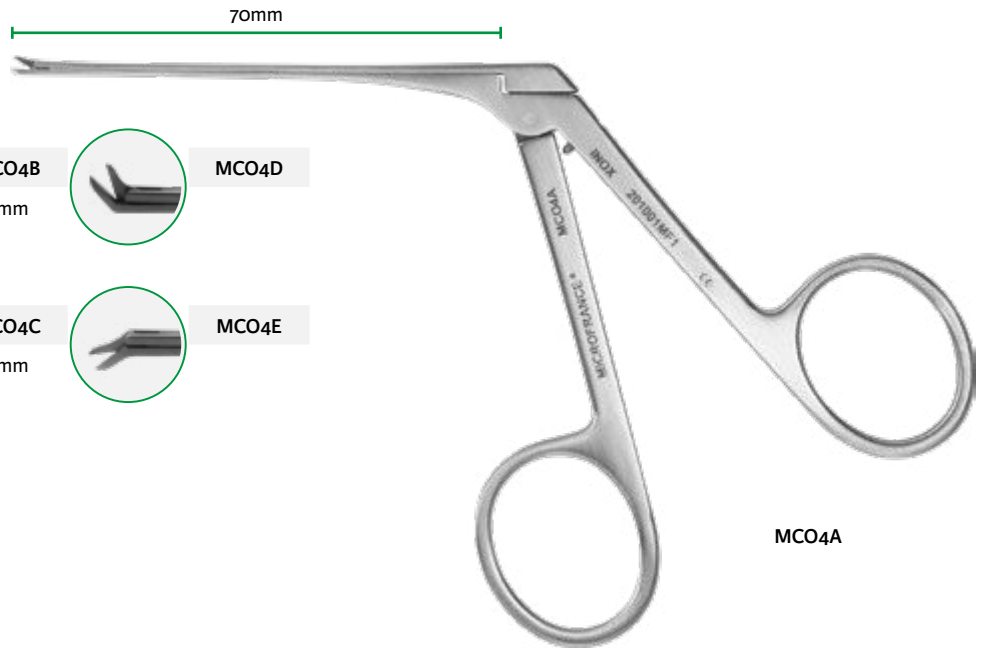
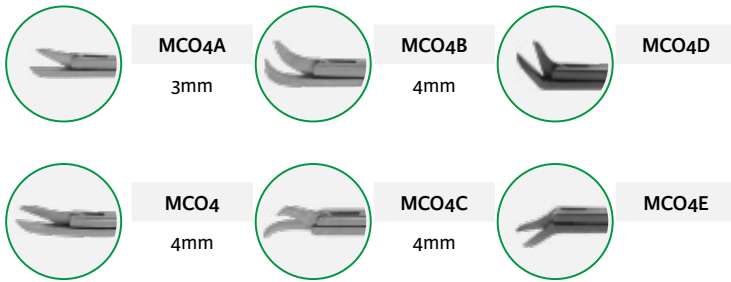

Micro cup forceps

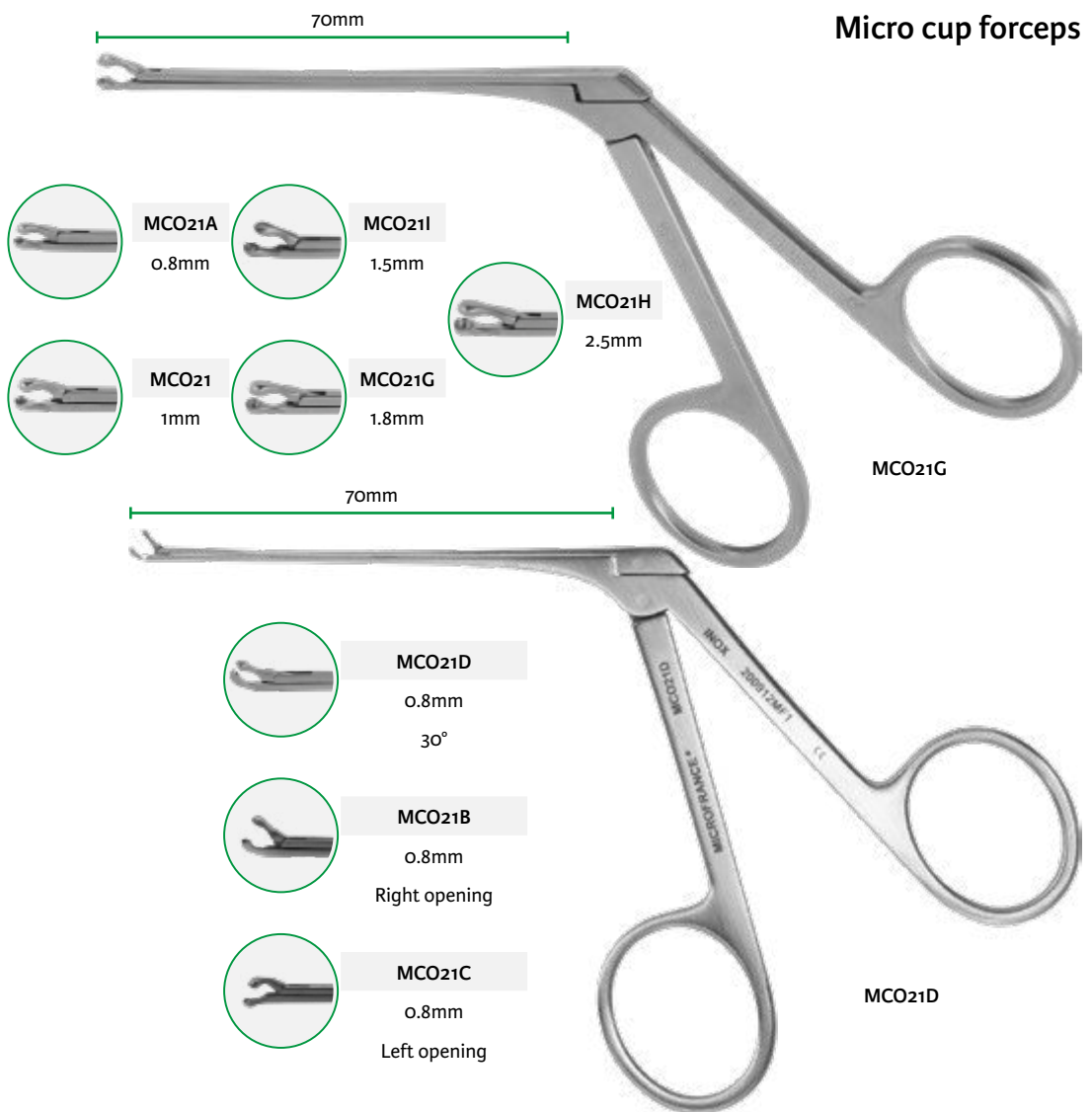

Kraus

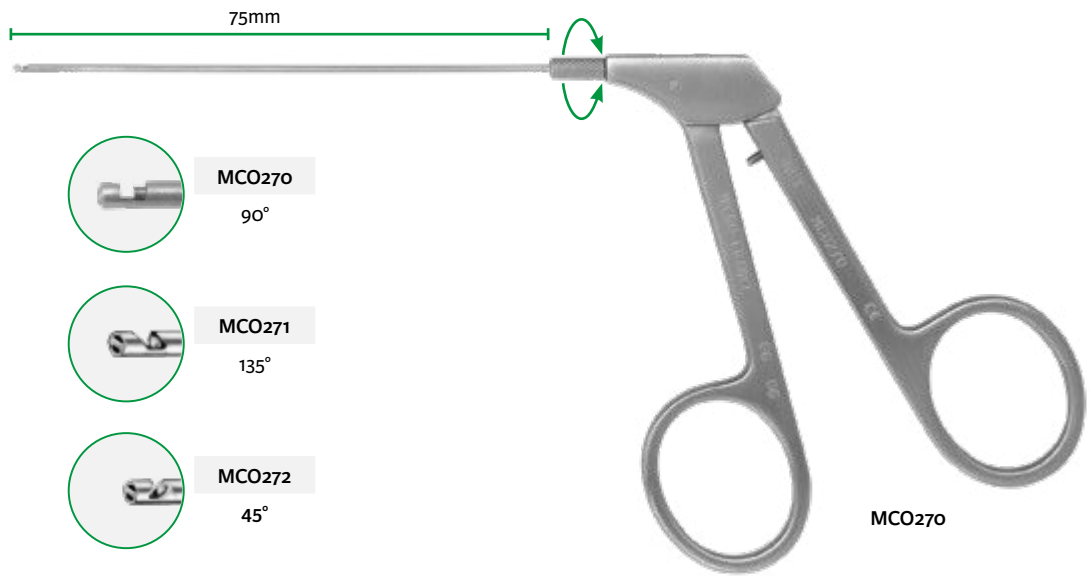

Dieter

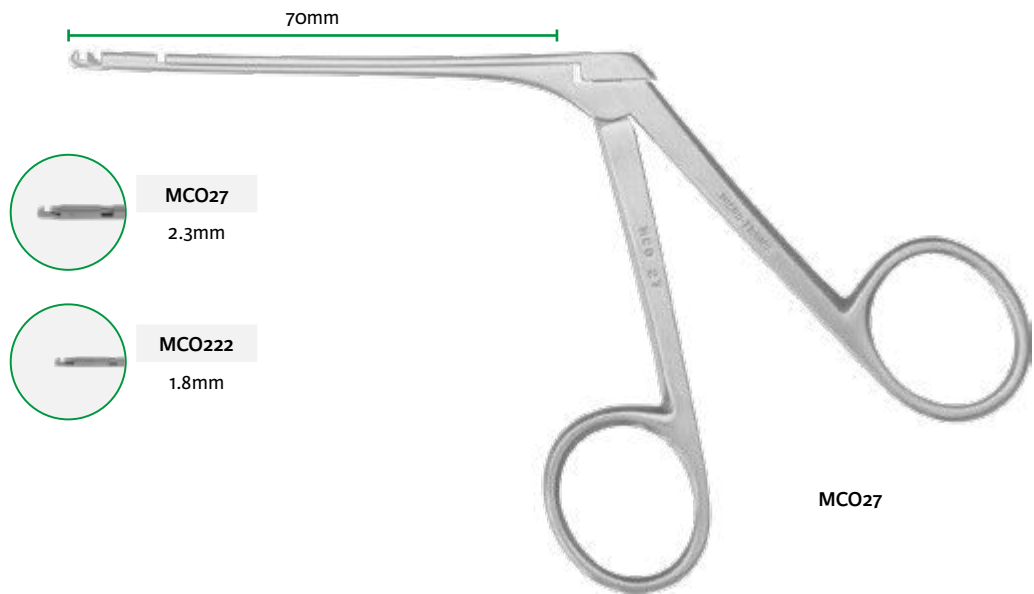

Dieter-Charachon

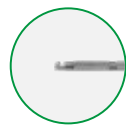

MCO222
1.8mm

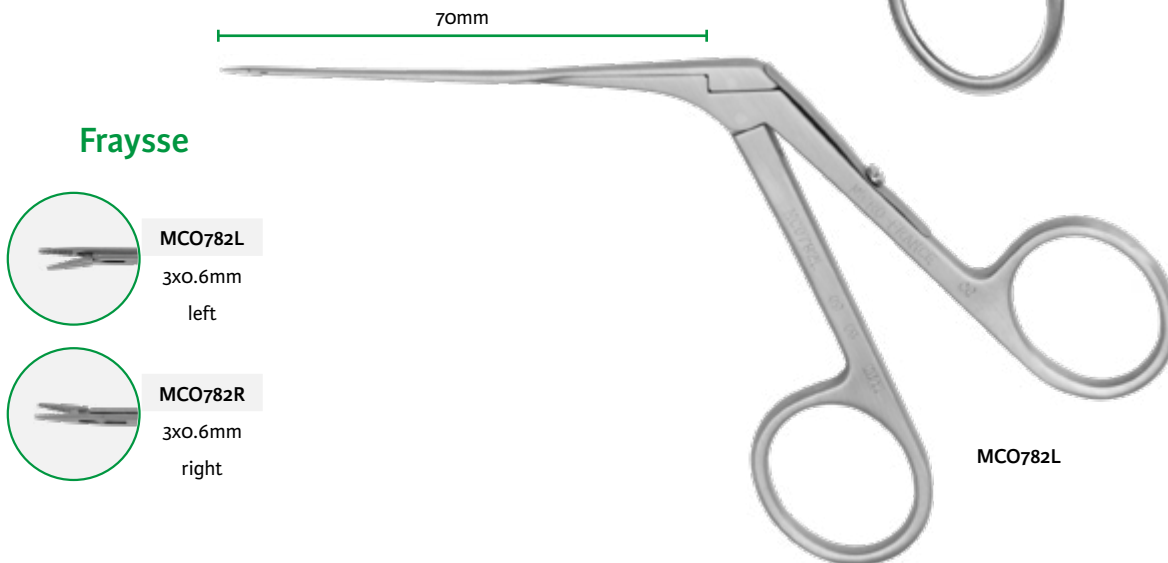
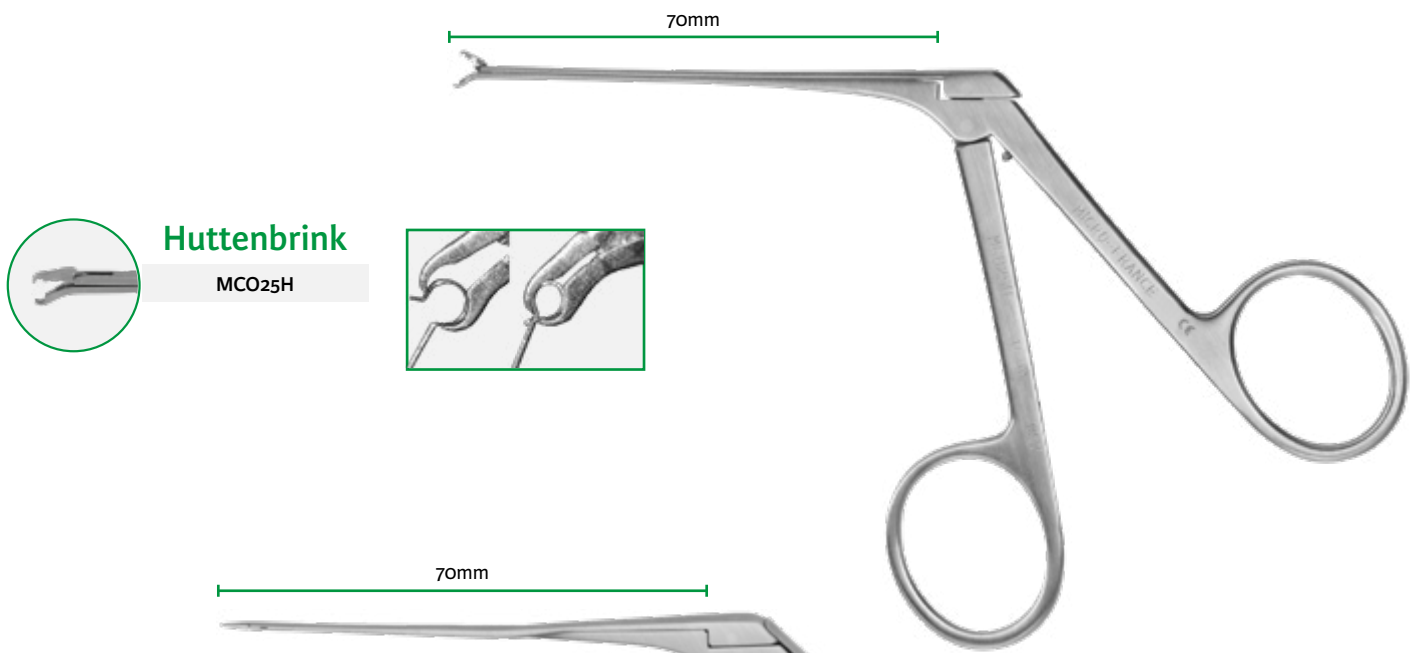
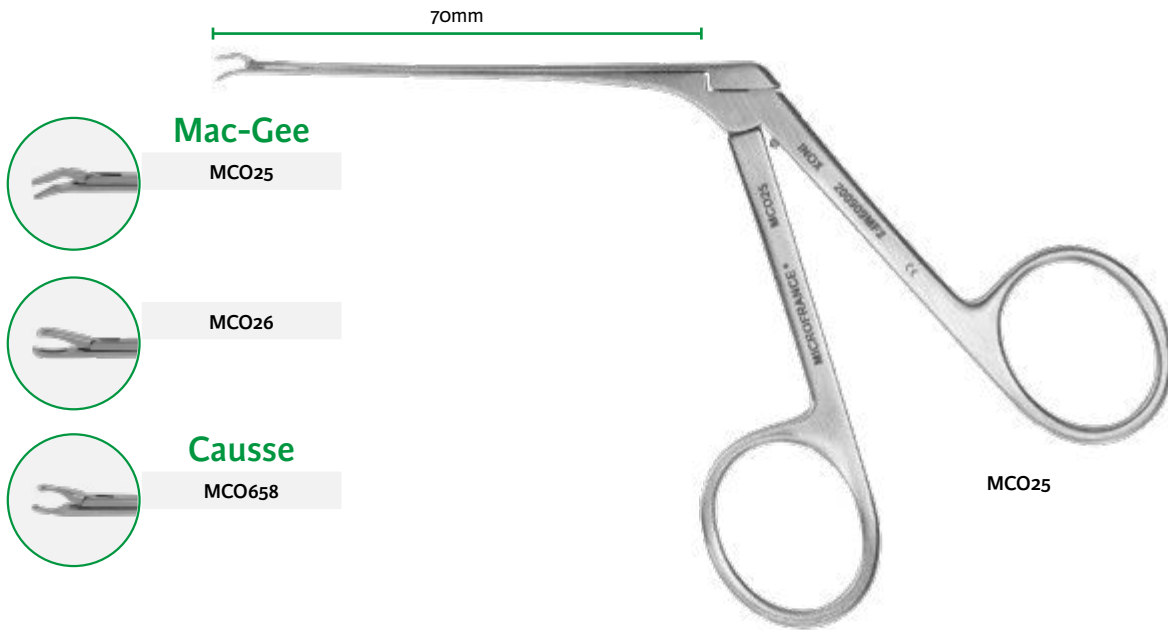



MCO5A-2-5
165mm



Micro knife 45°

Oval knife

Cause

Martin

45°

Rosen

Cause

Plester

MCO5A-2-5	2.5mm	MCO652	MCO215	MCO5C	MCO313	MCO653	MCO6
MCO5A-1-0	1mm	3mm	3mm	2.5mm	1.8x2.5mm	1.5x2mm	2x2.5mm
MCO5A-1-5	1.5mm		knife mirror	angled tip			
MCO5A-2-0	2mm						

Micro sickle knife

Micro lancet knife

Micro straight chisel

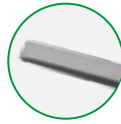
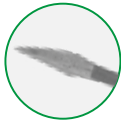
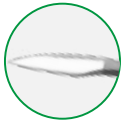

Rosen

Morgon

Jost

MCO10	MCO10B	MCO10M	MCO204C	MCO2
5mm	4.5mm	4mm	2x4mm	1.2mm



MCO650
165mm



Tip bent shaft

Cause

Frayse

Cause

Plester

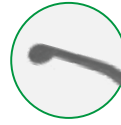
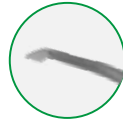
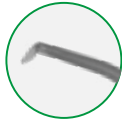

Micro knife

Micro lancet knife

Micro oval knife

MCO5B	MCO650	MCO5	MCO651F	MCO651	MCO6C
30° 2.5mm	90° 3mm	90° 2.5mm	90° 1.5x1.5mm	45° 1.5x2mm	30° 2x2.5mm



MCO5E
165mm

→ Suction



MCO5D
45°
2mm

Micro suction round knife



MCO5E
45°
3mm

Josephson



160mm

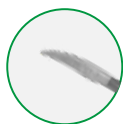

Sickle knife
3mm

MCO312
Double instrument

Micro knife
45°
1.5x3mm



Micro mirror



Micro raspatory

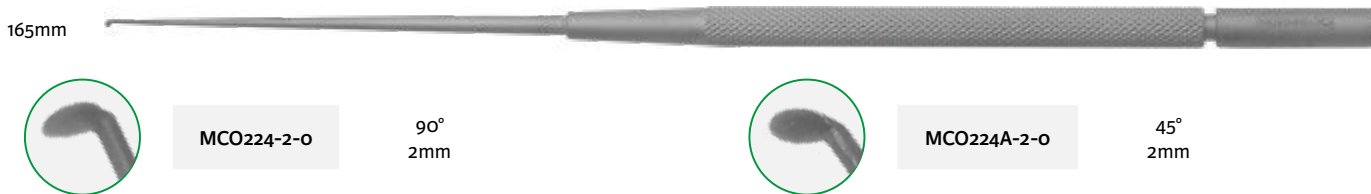

Micro angled elevator

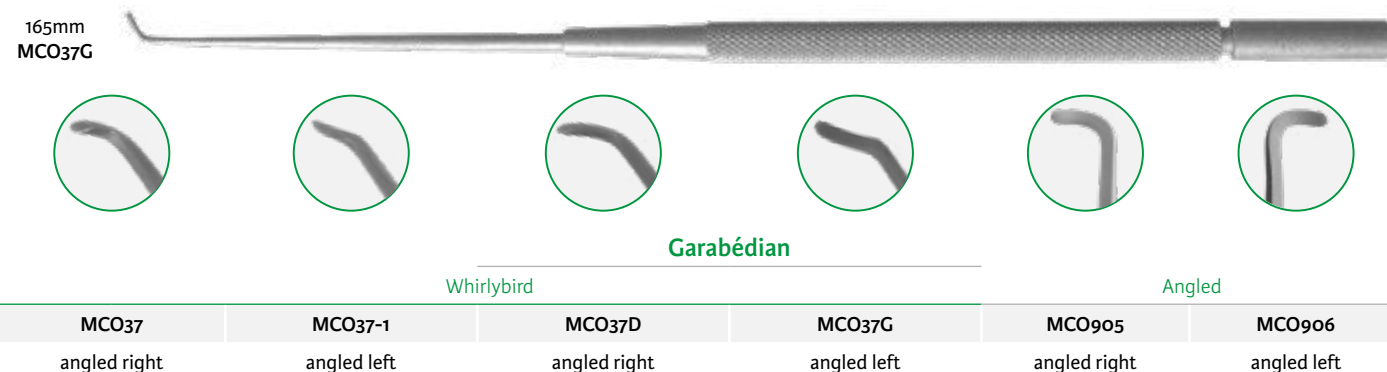

Micro curved elevator

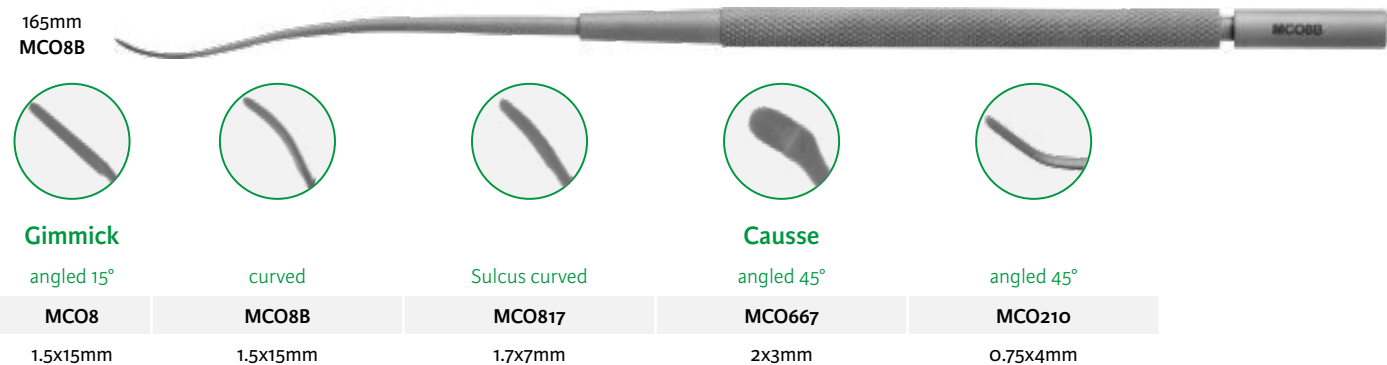

Micro double elevator

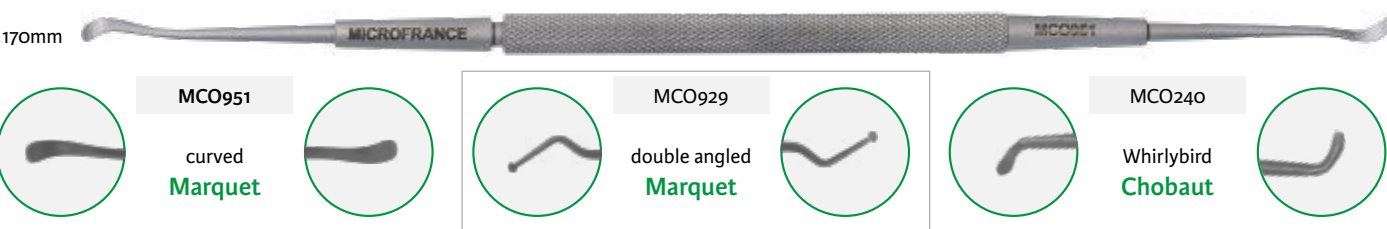



A
Volkmann straight curette 170mm

0	CP302-2	2mm
0	CP302-3	3mm
0	CP302-4	4mm
0	CP302-5	5mm
0	CP302-6	6mm
0	CP302-8	8mm

B
Micro fenestrated curette 165mm

	MCO207-1-5	1,5mm
	MCO207-2-0	2mm

C
Micro straight double curette 170mm

	MCO7-1	2,2 / 2,5mm n° 1/2
	MCO7-3	1,5 / 1,9mm n° 3/4

D
Micro angled double curette 155mm

	MCO7A-1	2,2 / 2,5mm n° 1/2
	MCO7A-3	1,5 / 1,9mm n° 3/4
	MCO7A-5	1 / 1,2mm n° 5/6

G
Micro straight curette 170mm

	MCO818	2,5mm
--	--------	-------

E
Micro double curette 155mm

Romanet

	MCO7A6	angled 1,7x3,2 / 1,3x2,3mm
--	--------	----------------------------------

F
Micro angled curette 160mm

Causse

	MCO655	2,8mm 45°
--	--------	-----------

Micro pick

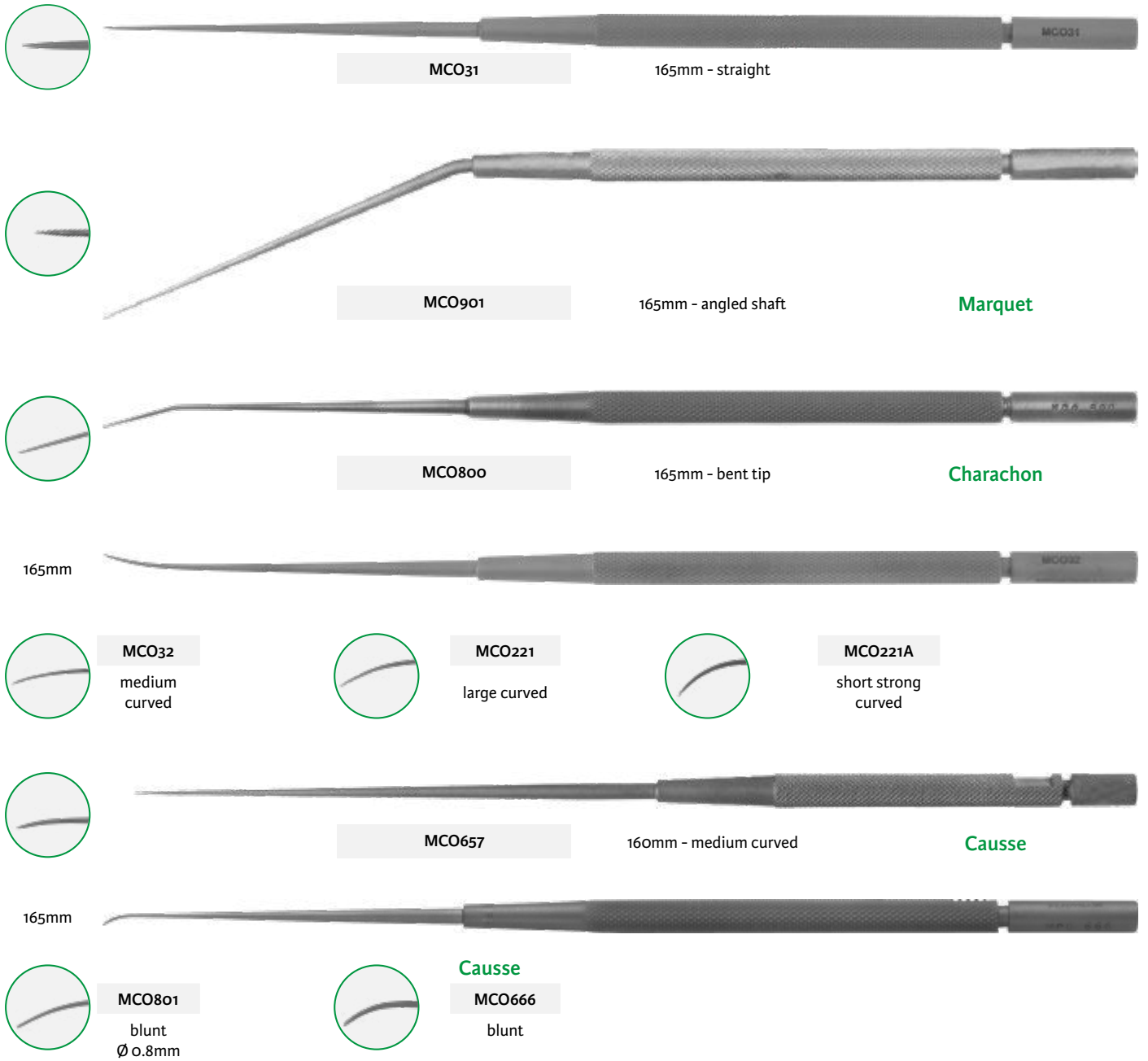



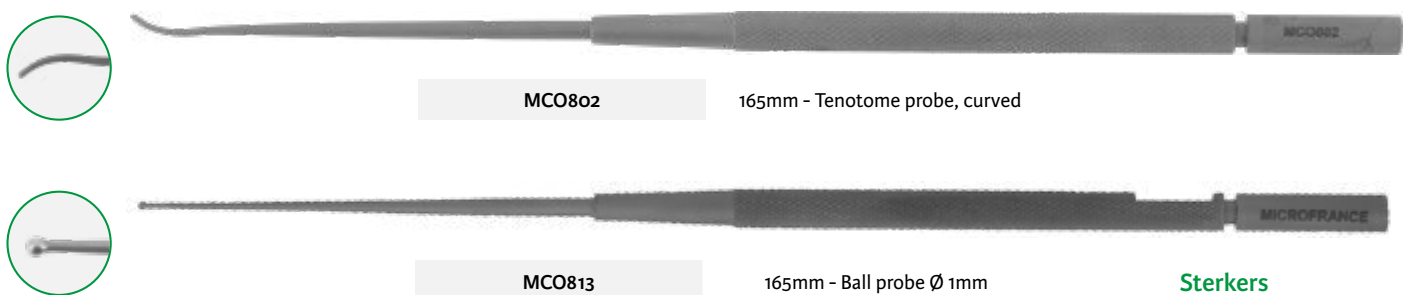









Tenotome probe - Ball probe



Micro hook, straight shaft

165mm
MCO6A









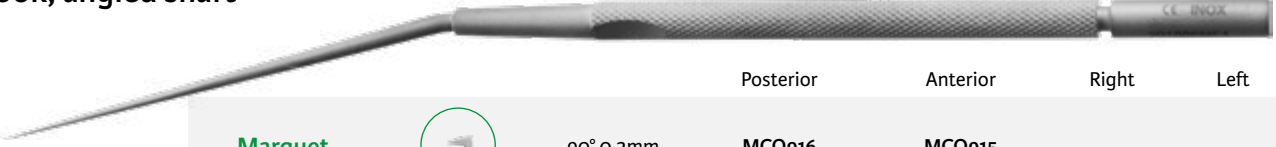

								
45°	MCO6A 0.7mm	Charachon 2mm	Legent 1mm		Marquet	Causse	Causse	Causse
								
90°	MCO205 0.3mm	MCO6B 0.7mm	MCO806A 2mm	MCO806B 4mm	MCO950 0.8mm	MCO654-1 1.2mm -right	MCO654-2 1.2mm - left	MCO841

Micro hook, angled shaft

165mm



				Posterior	Anterior	Right	Left
Marquet		90° 0.2mm	MCO916	MCO915			
Charachon		90° 0.2mm consolidated shaft	MCO832A	MCO832B	MCO832C	MCO832D	
Charachon		90° 0.3mm	MCO205A	MCO205B	MCO205C	MCO205D	
Causse		0.2mm	MCO663-2	MCO663-1			
Causse		0.4mm	MCO662-2	MCO662-1			
Causse		90° 0.4mm		MCO664			
Causse		90° 0.7mm		MCO665			
Marquet		45° 0.9mm		MCO920			

Micro hook, tip bent shaft

165mm



Poncet		90° 0.5mm	MCO226A Posterior	MCO226 Anterior	MCO226B Right	MCO226C Left
--------	---	--------------	----------------------	--------------------	------------------	-----------------

Micro joint knife



Cause

Micro raspatory



Micro hook - Micro raspatory



Thomassin

Thomassin

Micro instrument, spoon handle

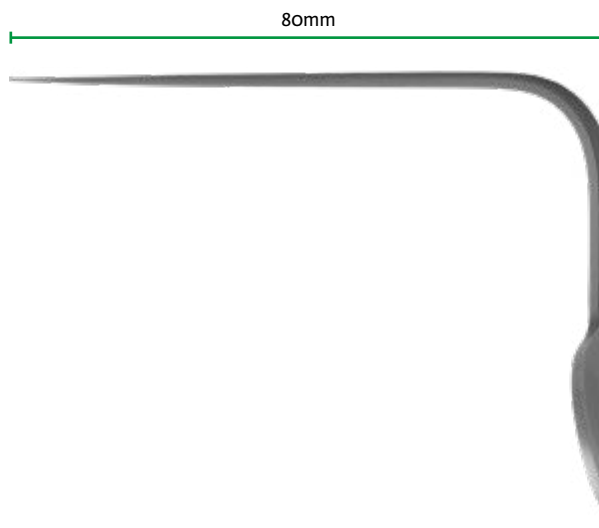

Portmann

Micro straight pick



Micro hook 90°



Monopolar curved elevator



MCO8BM

Bordure

140mm

Curved monopolar pick, blunt

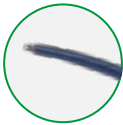

MCO989

Legent

180mm

Monopolar cables - 3.5 m

 CP391E Erbe ACC ICC/VIO Storz Wolf	 CP391M Aesculap Berchtold Lamidey Martin Erbe T Serie Sutter BM-780 II	 CP391V Bowa Bovie Conmed Valleylab
---	---	--

Bipolar forceps

Scale 1/4

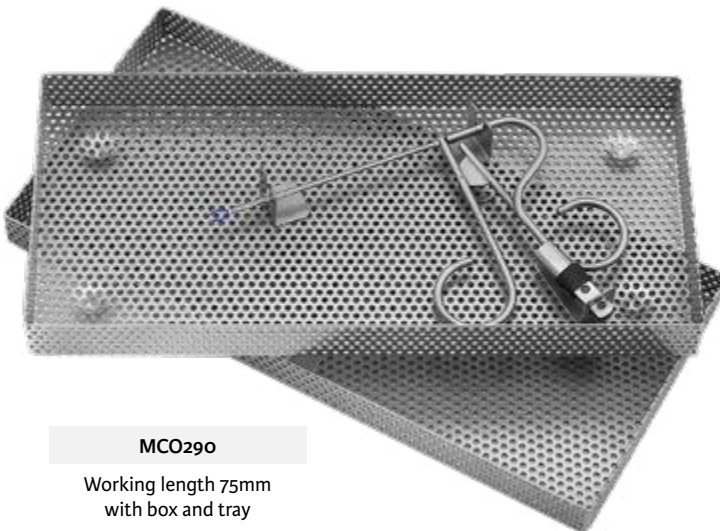

MCO290

Working length 75mm
with box and tray

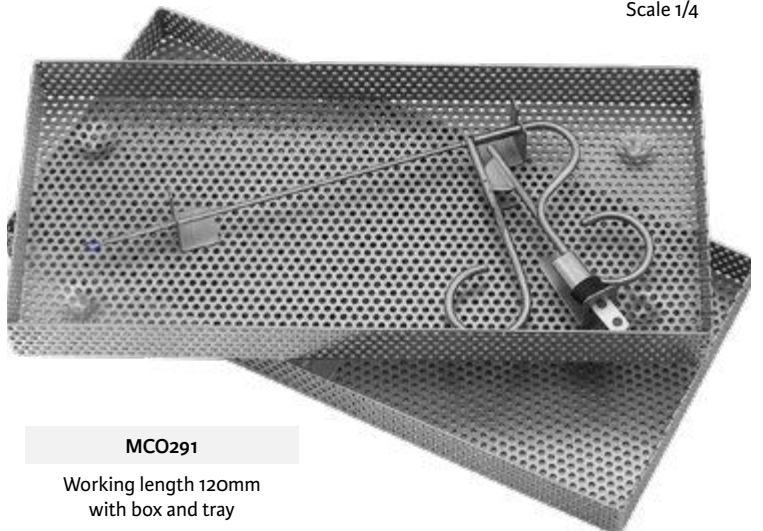

MCO291

Working length 120mm
with box and tray

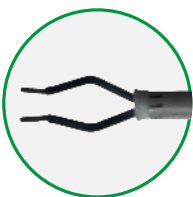

Bipolar cables - 4.5 m

 CP393-2 Bowa Emc Lamidey Valleylab	 CP393-3 Storz Wolf Erbe (except ICC VIO international)	 CP393-4 Aesculap Berchtold Martin Sutter BM-780 II
---	---	--

Micro measuring rod, angled shaft

165mm
MCO12B

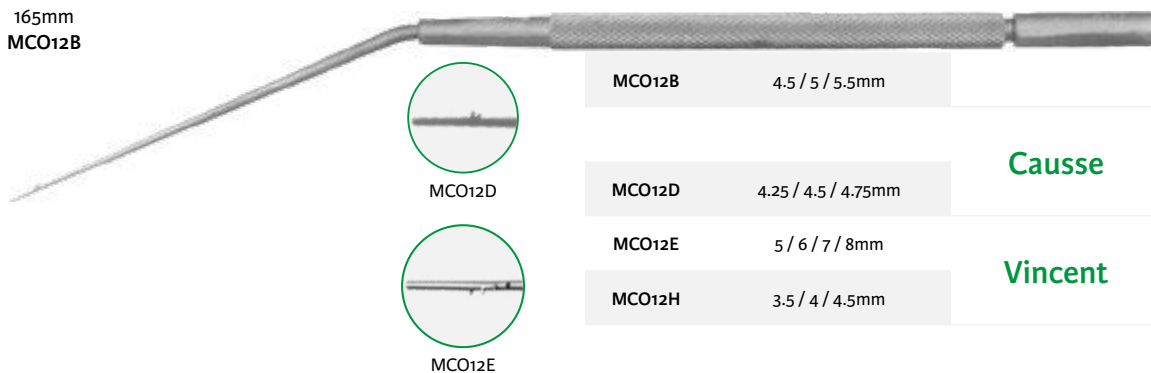

MCO12B 4.5 / 5 / 5.5mm

MCO12D 4.25 / 4.5 / 4.75mm

MCO12E 5 / 6 / 7 / 8mm

MCO12H 3.5 / 4 / 4.5mm

Cause

Vincent



MCO38 Micro measuring instrument

165mm

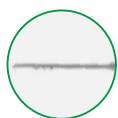

MCO12R malleable shaft 3 / 4 / 5mm

Robier

165mm



MCO830 straight shaft 3.5 / 4 / 4.5mm

Charachon

165mm

Micro measuring rod with protection sleeve

malleable

Ossiculoplasty sizer

MCOR45
165mm



MCOR20	MCOR25	MCOR30	MCOR35	MCOR40	MCOR45	MCOR50	MCOR55	MCOR60	MCOR65	MCOR70	MCOR75	MCOR80
2mm	2.5mm	3mm	3.5mm	4mm	4.5mm	5mm	5.5mm	6mm	6.5mm	7mm	7.5mm	8mm

Columella distance measuring rod forceps

Scale 2/3

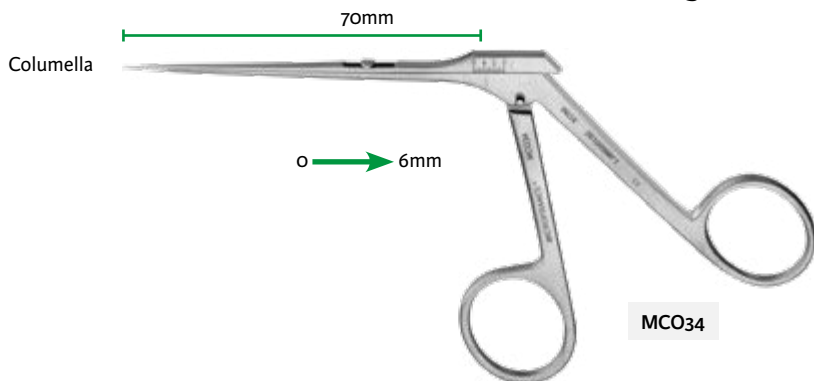
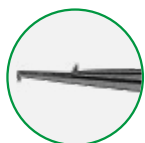

MCO34

Ossiculoplasty sizer

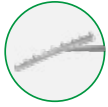

1 → 10mm

MCO844

Sauvage

165mm



Wire guide



MCO997

Legent

165mm



Micro Punch for silastic



Vincent

MCO571

Ø 2,5 - 0,8mm
for silastic 1128305

Schucknecht device



MCO985 Device

Fascia press

Scale 1/3



MCO819



MCO820

Martin

Cartilage cutting block

Teixido



MCO255

0.3mm height of cut

Martin



MCO250

0 to 1.5mm height of cut



Replacement blade

MCO251

Pack 10

Hand drill perforator

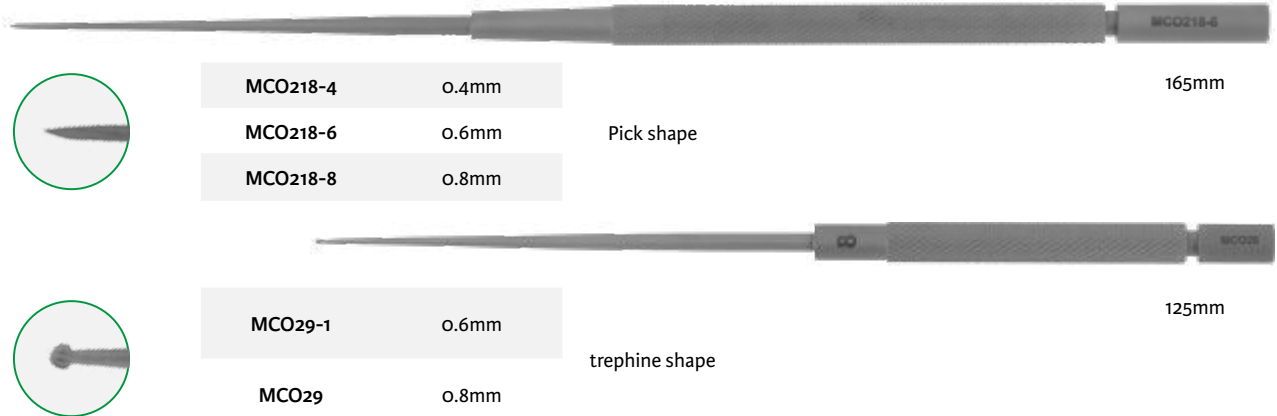

Piston trimming gauge

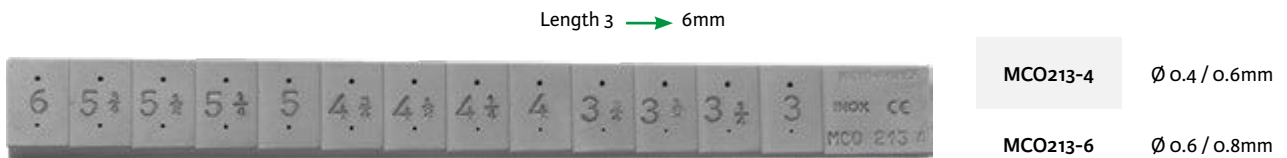

Preparation glass plate - Teflon cutting block



Cause

Preparation glass plate	
65x65x4mm	
with hole	
MCO660-10	hole 1.0mm
MCO660-12	hole 1.2mm
MCO660-8	hole 0.8mm
without hole	
MCO660-2	65x65x2mm

Otoplasty

Scale 1/1

Stenstrom



Rasp
160mm
2x8mm

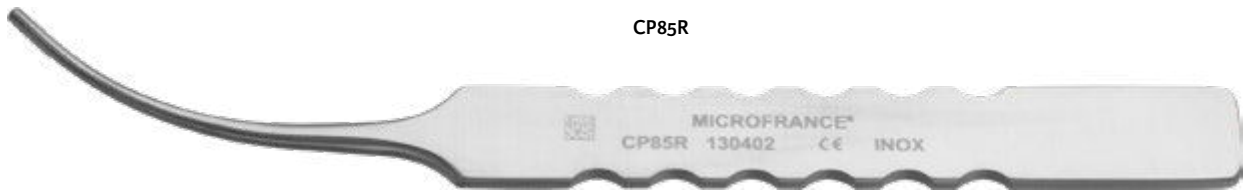

CP85R

MICROFRANCE®
CP85R 130402 CE INOX

CP85R

curved right

CP85L

curved left

Stenstrom

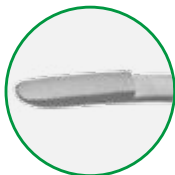

Elevators
160mm
2x8mm

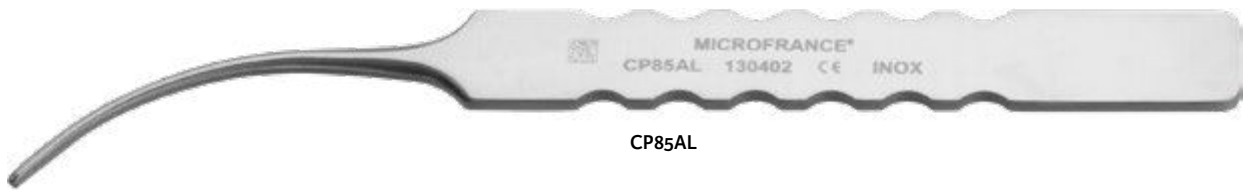

CP85AL

MICROFRANCE®
CP85AL 130402 CE INOX

CP85AR

curved right

CP85AL

curved left

Suction foot switch

Scale 1/5



Darrouzet

MCO551

Delivered with
Trumpet valve device
and security valve

Accessories for suction foot switch

Scale 1/2

security valve device - Pk 6

trumpet valve device



MCO551B



MCO551A

Temporal bone speciment holder

Scale 1/3































Ø 160mm

MCO823

Composition of Cause set

Reference	Description
7874MF-34	Stainless steel sterilization case 380x205x85mm 340x200x80mm
MCO670-1	Cause sterilization tray metal 335x195mm for container 7874MF-34
MCO12D	Cause measuring rod 4.25/4.5/4.75mm measurements angled shaft 165mm length
MCO12E	Vincent measuring rod 5/6/7/8mm measurements angled shaft 165mm length
MCO12H	Vincent measuring rod 3.5/4/4.5mm measurements angled shaft 165mm length
MCO13C	Hartmann forceps 0.6x3mm serrated jaws WL 65mm
MCO213-4	Piston trimming gauge with 0.4/0.6mm holes from 3 to 6mm 120mm length
MCO27	Dieter malleus nipper forceps 2.3mm jaws WL 65mm
MCO4A	Straight micro scissors blades 3mm tips WL 65mm
MCO571	Vincent punch 2.5x0.8mm diam. for Silastic 1128305
MCO650	Cause knife 90deg 3mm diam. tip bent shaft (A) 165mm length
MCO651	Cause lancet knife 1.5x2mm 45deg bent shaft (B) 165mm length
MCO652	Cause knife 45deg 3mm diam. tip (C) 165mm length
MCO653	Cause lancet knife 1.5x2mm 45deg (D) 165mm length
MCO654-1	Cause tendon hook cutting right 90deg 1.2mm (E1) 165mm length
MCO654-2	Cause tendon hook cutting left 90deg 1.2mm (E2) 165mm length
MCO655	Cause angled curette 2.8mm diam. tip (G) 160mm length
MCO656	Cause incudostapedial joint knife 45deg (H) 165mm length
MCO657	Cause curved pick (I) 160mm length
MCO658	Cause piston crimping forceps WL 65mm
MCO660-10	Cause preparation glass plate 65x65x4mm with hole 1mm diam.
MCO660-12	Cause preparation glass plate 65x65x4mm with hole 1.2mm diam.
MCO660-2	Cause preparation glass plate 65x65x2mm
MCO660-8	Cause preparation glass plate 65x65x4mm with hole 0.8mm diam.
MCO661-10	Cause malleable suction tube with luer-lock connection 1mm diam. WL 90mm
MCO661-7	Cause malleable suction tube with luer-lock connection 0.7mm diam. WL 90mm
MCO662-1	Cause anterior curved hook 0.4mm tip angled shaft (O1) 165mm length
MCO662-2	Cause posterior curved hook 0.4mm tip angled shaft (O2) 165mm length
MCO663-1	Cause anterior curved hook 0.2mm tip angled shaft (P1) 165mm length
MCO663-2	Cause posterior curved hook 0.2mm tip angled shaft (P2) 165mm length
MCO664	Cause anterior hook 90deg 0.4mm tip angled shaft (Q) 165mm length
MCO665	Cause anterior hook 90deg 0.7mm tip angled shaft (R) 165mm length
MCO666	Cause curved pick blunt (S) 165mm length
MCO667	Cause flap elevator 2x3mm 45deg 165mm length
MCO820	Martin fascia press
MCO841	Cause hook 90deg (F) 165mm length

Composition of the complete set on request

		
MCO13C	MCO213-4	MCO27
		
MCO4A	MCO571	MCO820
		
MCO650	MCO651	MCO652
		
MCO653	MCO654-1	MCO654-2
		
MCO655	MCO656	MCO657
		
MCO662-1	MCO663-1	MCO665
		
MCO657	MCO658	MCO841
		
MCO12H	MCO12E	MCO661-10
		
MCO660-12	MCO660-2	
		
MCO670-1	7874MF-34	

Picture for information, without scale

MCO901



Instruments 165 mm angled shaft

Straight pick	Chisel	Anterior hook 90° 0.2mm	Posterior hook 90° 0.2mm	Anterior hook 45° 0.9mm	Raspatory upward	Raspatory backward
MCO901	MCO910M	MCO915	MCO916	MCO920	MCO917	MCO918



Instruments 165 mm straight shaft

Knife 45° 2.8X3.5mm	Blunt hook 90° 0.8mm	Elevator 60° 1.3x2mm	Angled elevator right	Angled elevator left	Ball probe 1mm
MCO932	MCO950	MCO904	MCO905	MCO906	MCO924



Double elevators

	MCO925 180mm 3mm			MCO929 170mm double angled	
	MCO926 180mm flat 1.7 / 5mm			MCO951 170mm curved	
	MCO928 175mm curved 0.9mm				

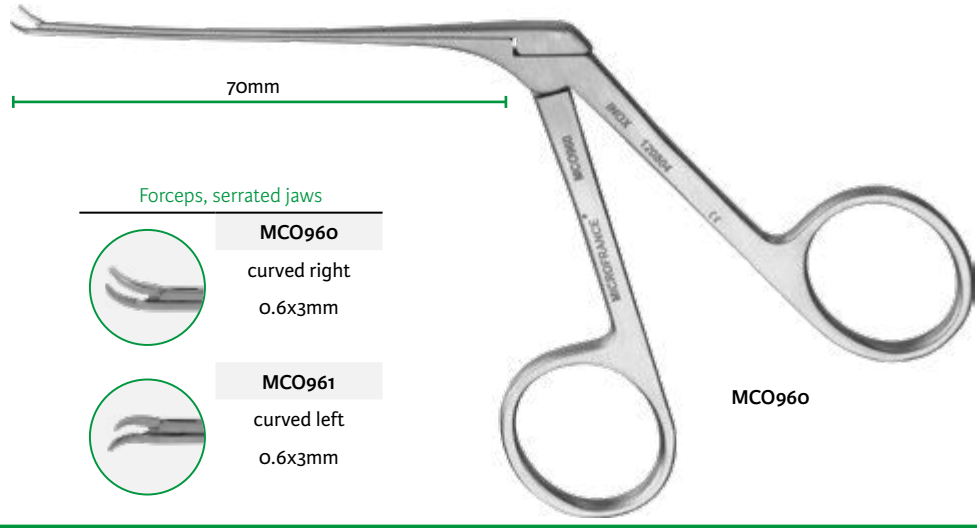

Forceps, serrated jaws

	MCO960 curved right 0.6x3mm
	MCO961 curved left 0.6x3mm

MCO960



Whirlybird elevator, angled, 165mm



3722001 0,75mm left

3722002 0,75mm right

Guilford-Wright instruments



Micro hook 0,5mm 165mm



3722020 45°

3722021 90°

Shea instrument



Micro hook 90° 165mm



3722142 1mm



Micro knife 165mm

A	3722031	45°	Ø 2mm
----------	----------------	------------	--------------

Hook 90° 165mm

B	3722035	0,6mm
----------	----------------	--------------

Stapedectomy hook 165mm

C	3724287	45°	0,33mm
----------	----------------	------------	---------------

Excavator, angled shaft, 160mm

D	3724291	90°	0,5mm
----------	----------------	------------	--------------

Jordan instrument



Stapedectomy lancet knife 165mm



3724293

45°

2x3mm

Micro raspatory - Micro hook



MCO9-1

Raspatory 90°



MCO804

Hook 90° 0,7mm

Micro double angled elevator



MCO929

double angled

Marquet



MCO240

double angled

whirlybird

Chobaut

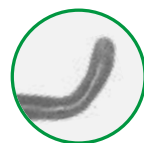
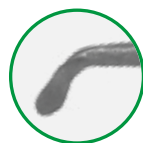

Suction tube adapter - Micro angled suction tube

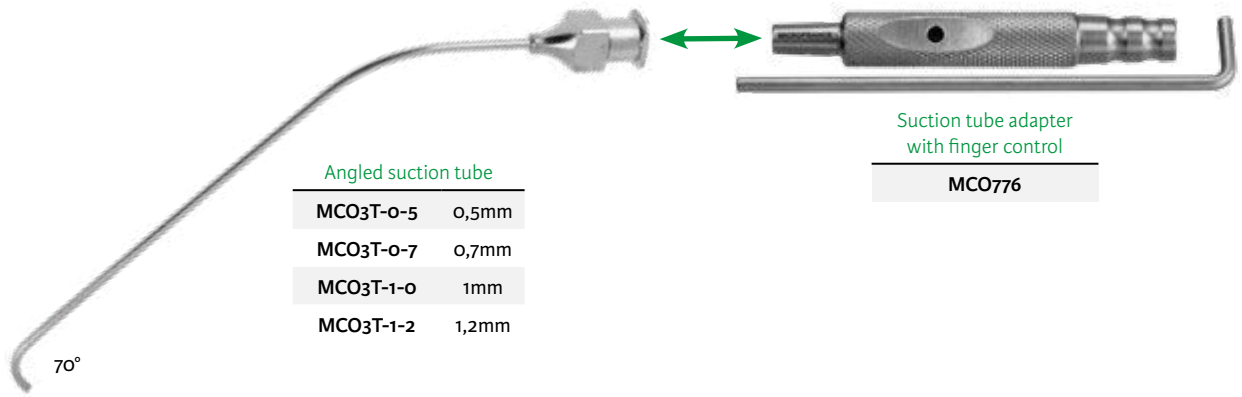

Micro forceps

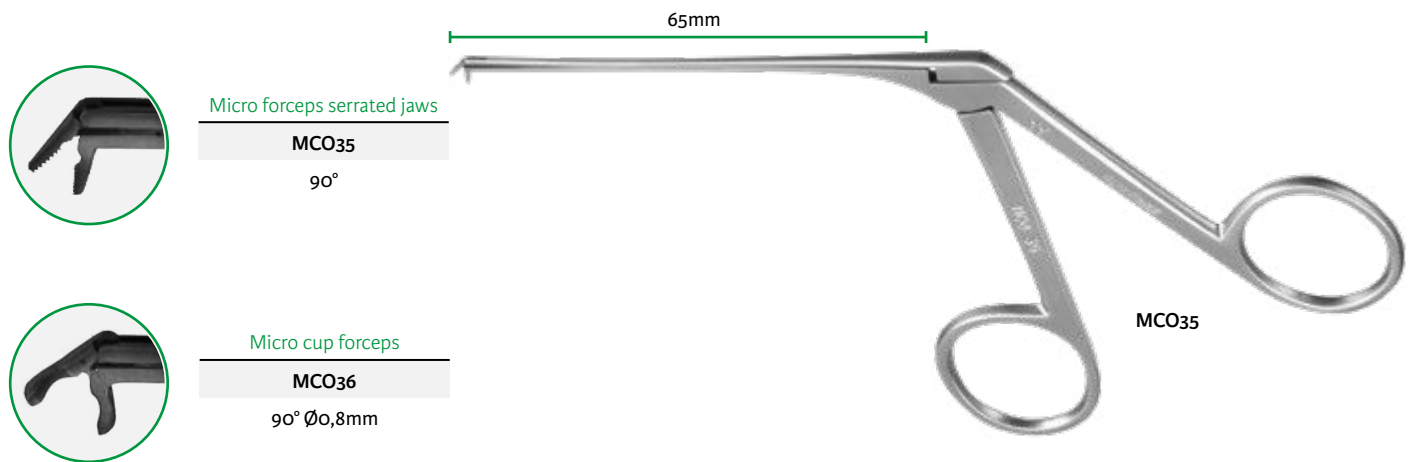

Container - Tray

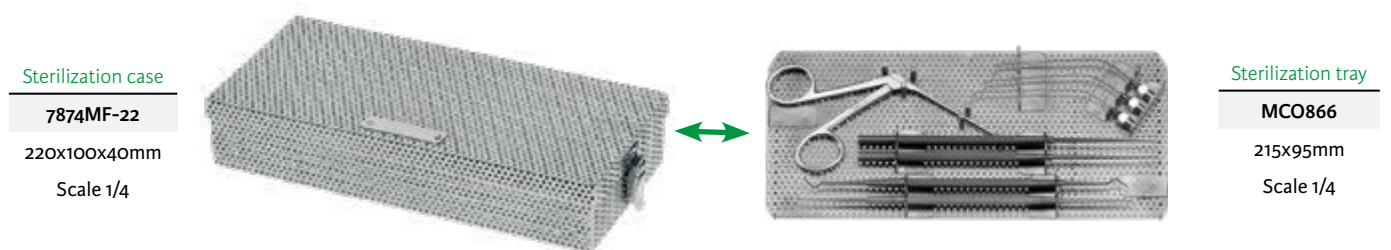

Micro lancet knife

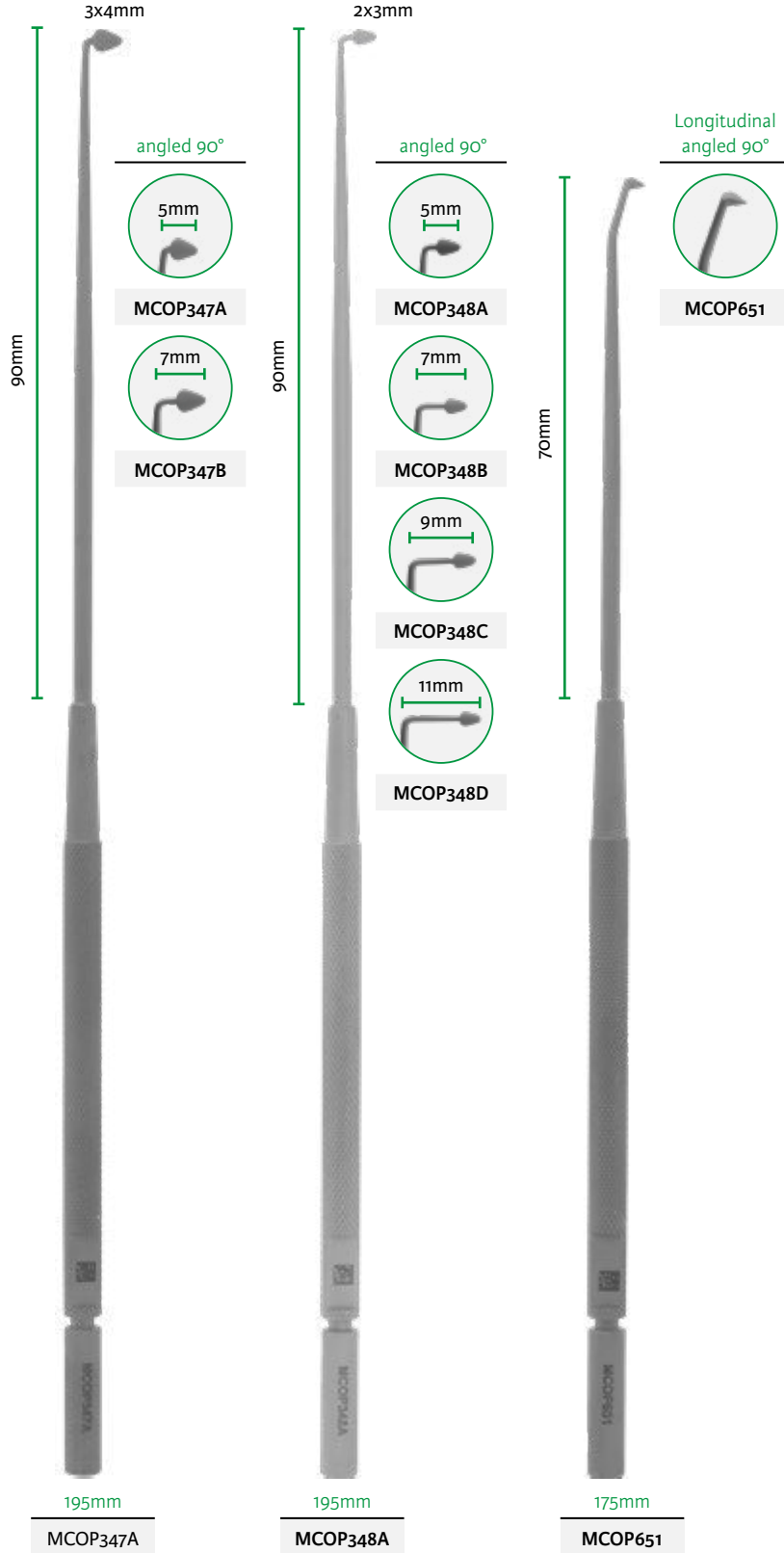

Sterilization tray
MCO821-1

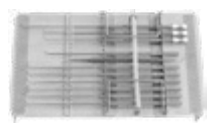

Container
25x15x6cm
7874MF-25

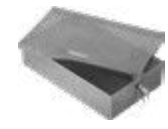

Micro curette Suction tube elevator

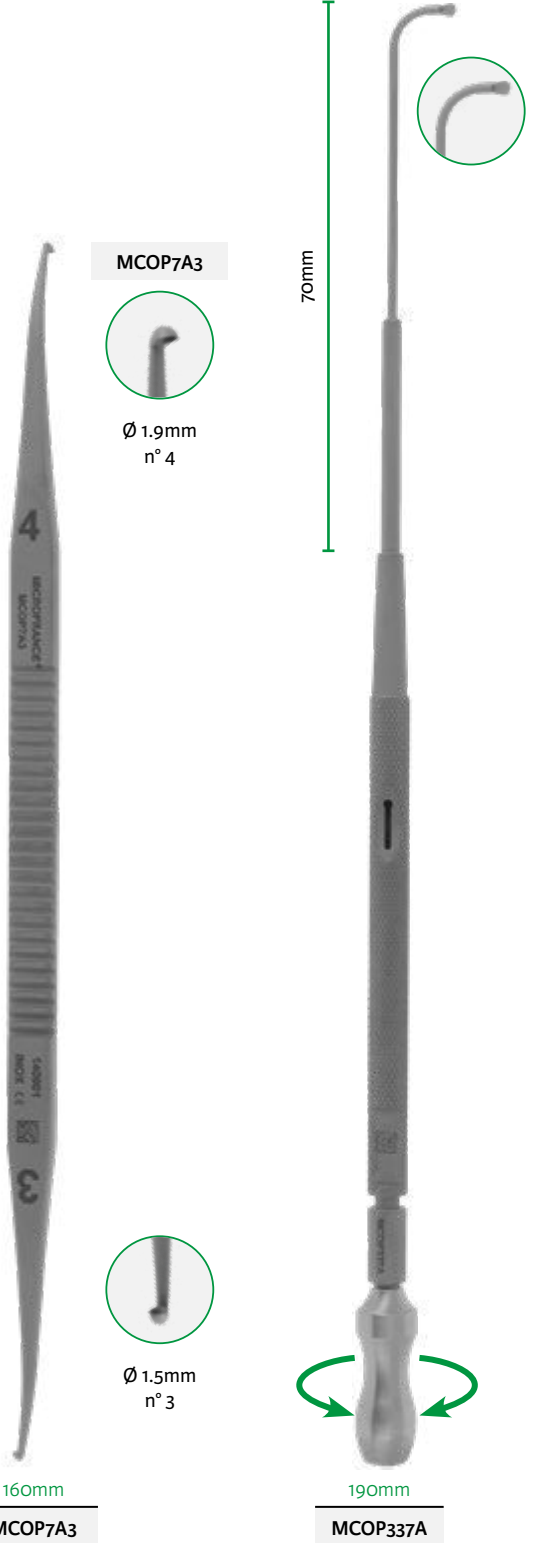

Suction tube with finger control

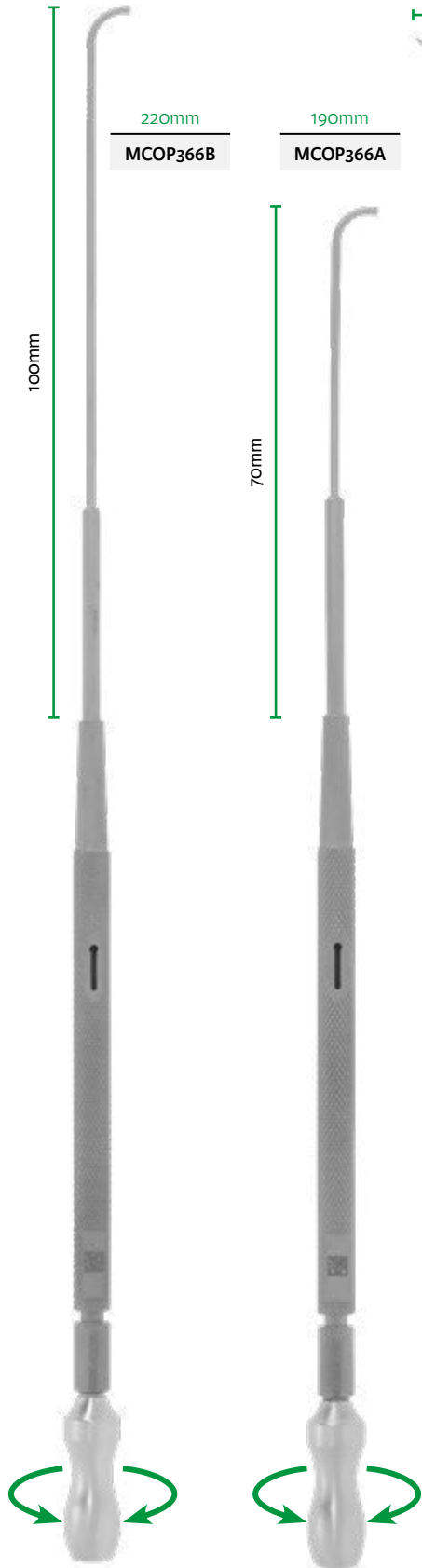

Alligator forceps

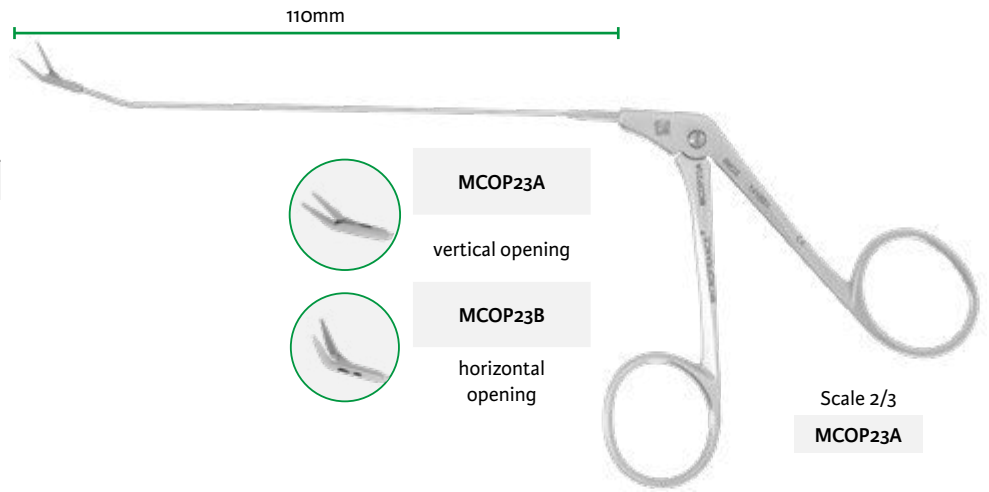

Wire crimper forceps

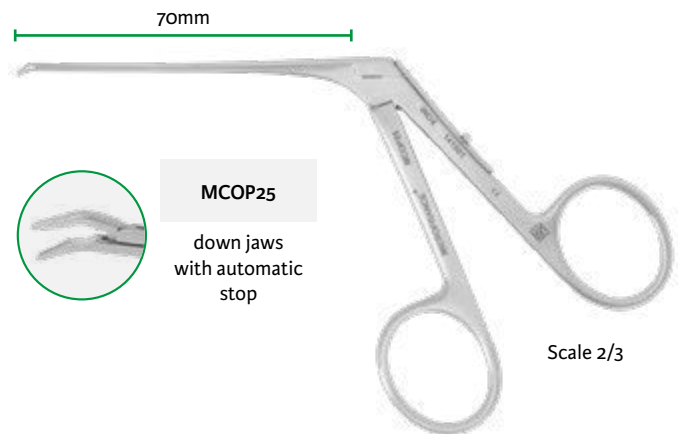

Fascia press

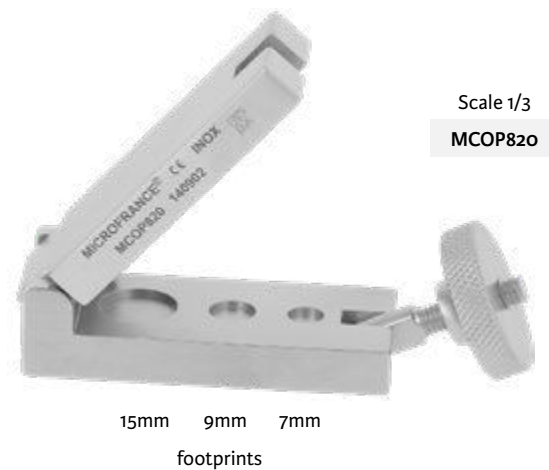

Scale 2/3

«L» Working length



Fraysse

Micro blunt eyes suction tube

115mm

L 115mm		L 150mm	
MCO367F10	1mm	MCO368F20	2mm
MCO367F12	1.2mm	MCO368F25	2.5mm
MCO367F15	1.5mm		
MCO367F20	2mm		

MCO367F10

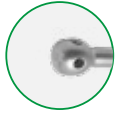

Zimmermann

100mm

MCO354	1.2mm
--------	-------

MCO354



Charachon

Micro suction tube with finger control

140mm

blunt eyes suction tube

L 110mm		L 140mm	
MCO352E20	2mm	MCO352N20	2mm
MCO352E25	2.5mm	MCO352N25	2.5mm

MCO352N25



MCO770L15	1.5mm
MCO770L20	2mm
MCO770L25	2.5mm

MCO770L30	3mm
MCO770L35	3.5mm
MCO770L40	4mm

120mm

blunt eyes suction tube

MCO770L30



Brackman

Micro suction irrigation tube with finger control

90mm

MCO352-20	2mm
MCO352-25	2.5mm
MCO352-30	3mm

blunt eyes suction tube

MCO352-25

Micro scissors, micro forceps

Sterkers

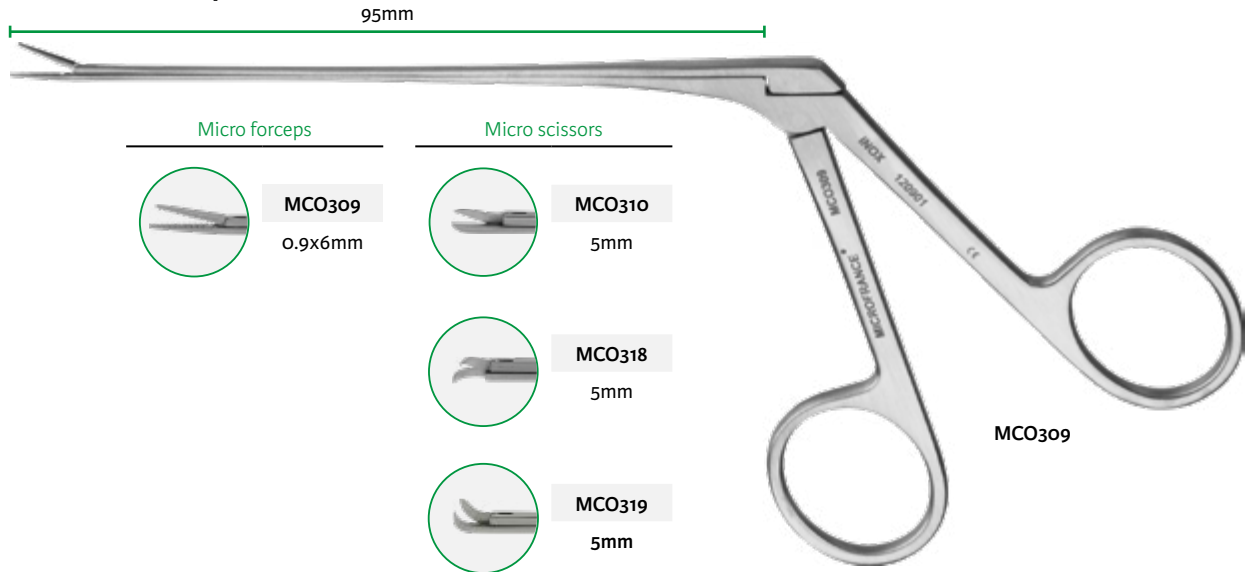

Self-retaining retractor

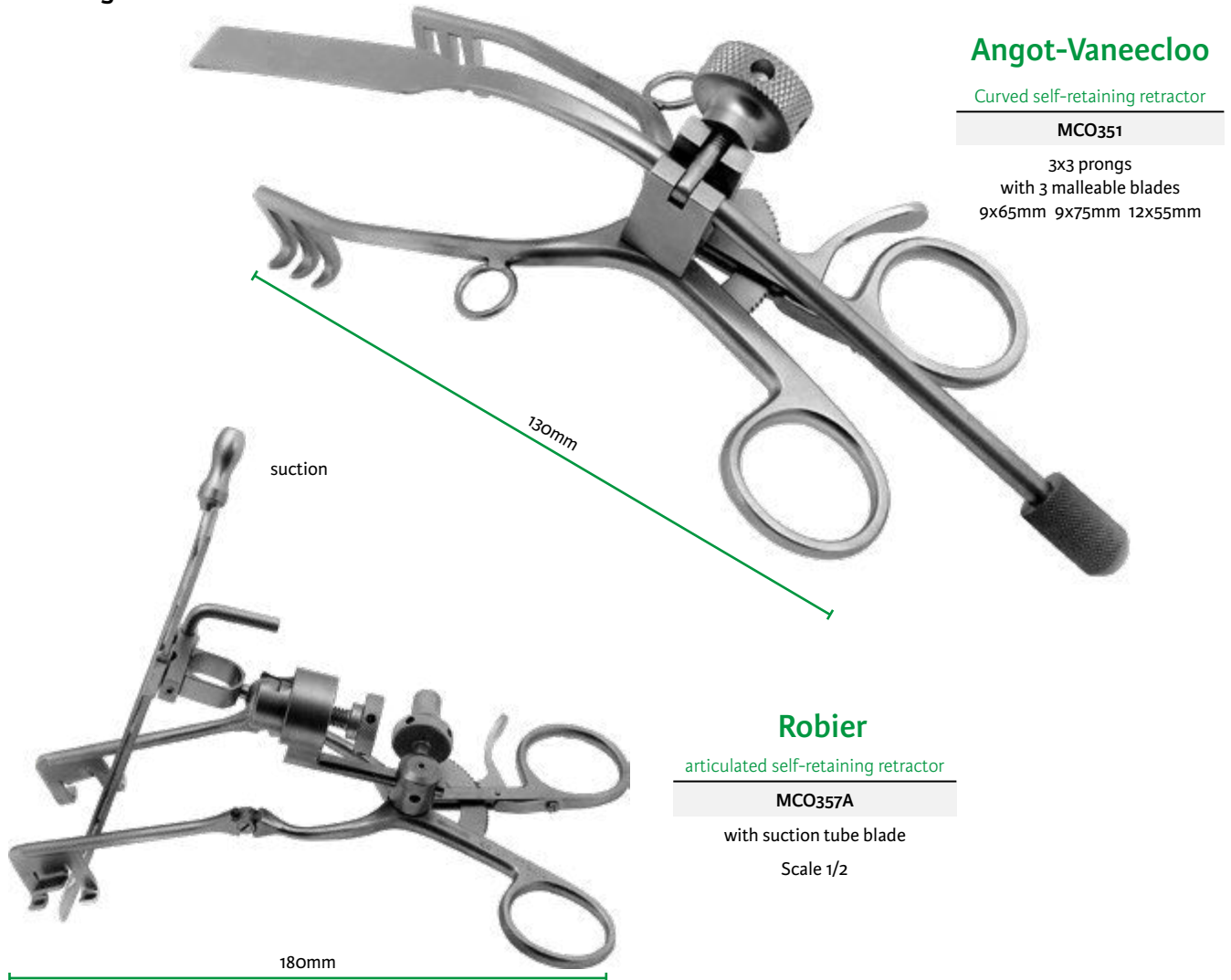

Angot-Vaneecloo

Curved self-retaining retractor

MCO351

3x3 prongs
with 3 malleable blades
9x65mm 9x75mm 12x55mm

Robier

articulated self-retaining retractor

MCO357A

with suction tube blade

Scale 1/2

Scale 2/3

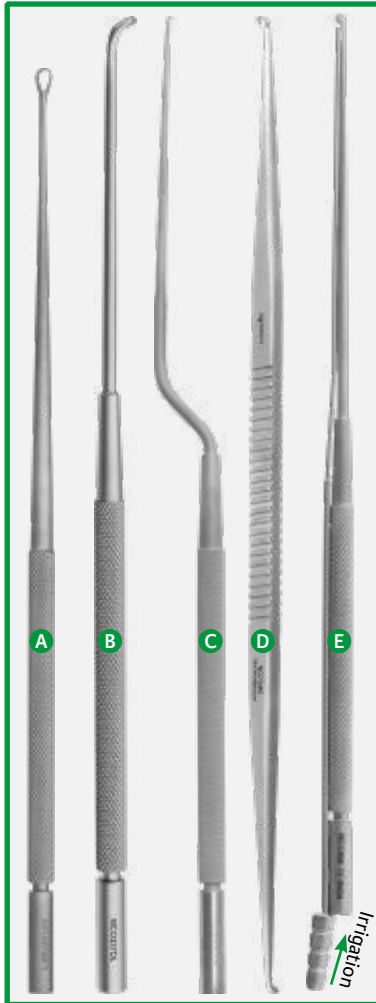

Micro instruments

Sterkers

Sickle knife 180mm		MCO301	7mm
		MCO302	90° 2mm
Hook 180mm		MCO303	90° 1.2mm
		MCO304	90° 0.8mm
Fenestrated curette 180mm		MCO320 A	3mm
		MCO321	4mm
		MCO322	6mm

Instruments, tip bayonet shaft

Hook 190mm		MCO341	2mm left
Magnan		MCO340 C	2mm right
Blunt pick 190mm		MCO342	straight
Bruzzo		MCO343	curved

Elevator and raspatory

Whirlybied elevator 180mm		MCO337DL B	left
Dubreuil		MCO337DR	right
Raspatory 175mm		MCO224G	45° 7x4mm
Gentine			
Elevator 195mm		MCO333	curved 1.5x7mm
Klap			

Mom micro instruments

Mom

Angled curette double 190mm		MCO7AMO D	2.2 / 2.5mm n° 1/2
Oval knife 190mm		MCO6M E	2x2.5mm with irrigation
Sickle knife 190mm		MCO10MO	5mm with irrigation
Curved pick 190mm		MCO221MO	with irrigation
Ball seeker 190mm		MCO330MO	2mm 90° with irrigation







Micro instruments



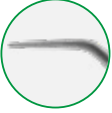
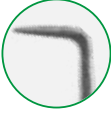

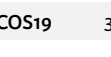

Selesnick

Scale 2/3

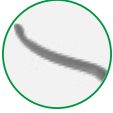

190mm

Hook			Knife 45°			Curette	
							
MCOS14	MCOS15	MCOS16	MCOS17	1mm	MCOS18	MCOS25	MCOS26
45° 3mm	90° 2mm	90° 2.8mm		2mm		Ø 1mm straight	Ø 1mm angled
				3mm			

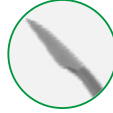
Elevator					Sickle knife	
						
MCOS20	MCOS21	MCOS22	MCOS23	MCOS30	MCOS31	MCOS32
14 x 1.5mm	3mm	5 x 1mm	7 x 2mm	left	right	5mm



Cup forceps, micro scissors



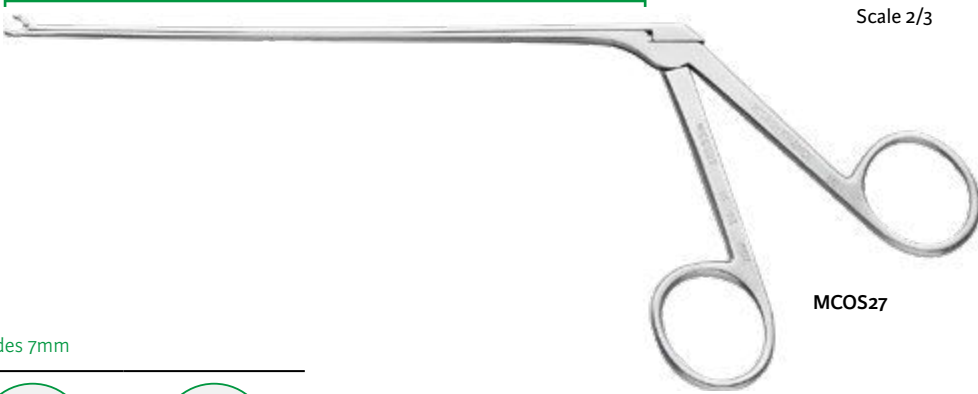

125mm

Scale 2/3



MCOS27

Cup forceps	
	
MCOS27	MCOS29
1mm	3mm

Micro scissors, blades 7mm			
			
MCOS33	MCOS34	MCOS35	MCOS36
straight	angled up	left curved	right curved

Curved self-retaining retractor

Angot-Vaneecloo

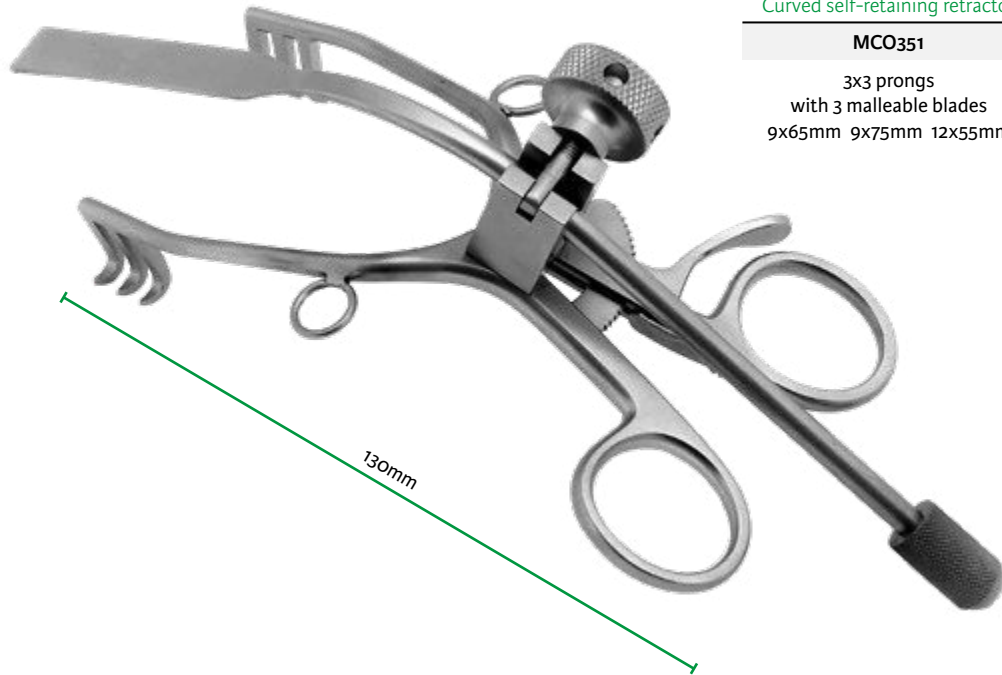

Curved self-retaining retractor

MCO351

3x3 prongs
with 3 malleable blades
9x65mm 9x75mm 12x55mm

Bipolar forceps

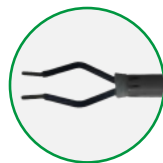
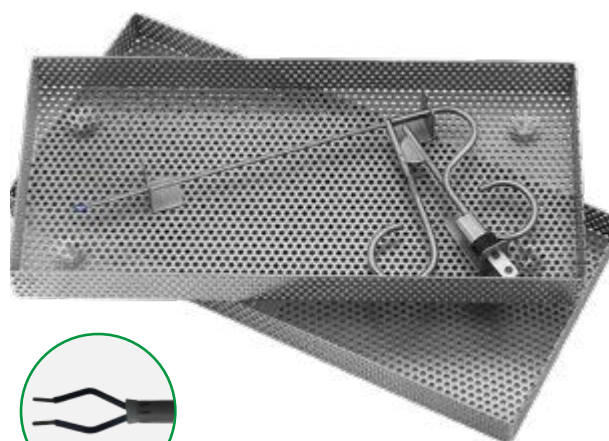

Bipolar forceps

MCO291

Working length 120mm
with box and tray
Scale 1/3

Page 33

Knife		Burr				Drill burr	
Diamond	Tungsten round burr	Diamond	Perforer six sided	Six sided	Drill burr	Lindemann Drill burr	
shaft 44mm	shaft 65mm	shaft 65mm	shaft 65mm	shaft 65mm	shaft 55mm	shaft 33mm	shaft 50mm

MCO702-22^(D)
Pack 1
Ø 22 mm



Ø mm	Pack 1	Pack 1	Pack 6	Pack 1	Pack 4	Pack 1	Pack 1
0.6	236HM-0-6 ^(D)	242-0-6 ^(D)	-	-	-	-	-
0.7	-	242-0-7 ^(D)	-	-	-	-	-
0.8	236HM-0-8 ^(D)	242-0-8 ^(D)	-	-	-	-	-
1.0	236HM-1-0 ^(D)	242-1-0 ^(D)	-	-	-	-	-
1.2	-	-	-	-	2035512C4 ^(D)	-	-
1.4	236HM-1-4 ^(D)	242-1-4 ^(D)	-	-	-	-	-
1.5	-	-	-	-	2035515C4 ^(D)	-	-
1.8	236HM-1-8 ^(D)	242-1-8 ^(D)	-	-	-	164RS-1-8 ^(D)	-
2.3	236HM-2-3 ^(D)	242-2-3 ^(D)	141P23 ^(D)	-	-	-	168RS ^(D)
2.7	236HM-2-7 ^(D)	242-2-7 ^(D)	141P27 ^(D)	-	-	-	-
3.0	236HM30 ^(D)	-	-	-	-	-	-
3.1	-	242-3-1 ^(D)	141P31 ^(D)	141RS-3-1 ^(D)	-	-	-
3.5	236HM-3-5 ^(D)	242-3-5 ^(D)	-	-	-	-	-
4.0	236HM-4-0 ^(D)	242-4-0 ^(D)	-	141RS-4-0 ^(D)	-	-	-
4.5	236HM-4-5 ^(D)	242-4-5 ^(D)	-	-	-	-	-
5.0	236HM-5-0 ^(D)	242-5-0 ^(D)	-	141RS-5-0 ^(D)	-	-	-
6.0	-	242-6-0 ^(D)	-	-	-	-	-
7.0	236HM-7-0 ^(D)	242-7-0 ^(D)	-	-	-	-	-

Sterilization tray



MCO865-1

for 26 burs - Scale 1/5

Sterilization case



7874MF-22

240x105x45mm 220x100x40mm - Scale 1/5

^(D) Distributed by Integra MicroFrance SAS (France) - For corresponding manufacturer part numbers, see table in annex

Stainless steel cup



7876-60^(D)

Cup

7876-60 ^(D)	60mm
7876-80 ^(D)	80mm
7876-100 ^(D)	100mm
7876-120 ^(D)	120mm
7876-160 ^(D)	160mm

Stainless steel sterilization tray



7872-24^(D)
Scale 1/2

Tray

7872-24 ^(D)	240x180mm
------------------------	-----------

Surgical instrument paraffin oil



Paraffin oil

MCO731^(D)

^(D) Distributed by Integra MicroFrance SAS (France) - For corresponding manufacturer part numbers, see table in annex

Scale 1/5



7874MF-22

240x105x45mm
220x100x40mm

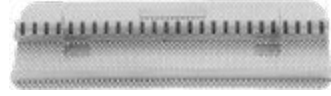

MCO865-1

for 26 burs

Scale 1/5

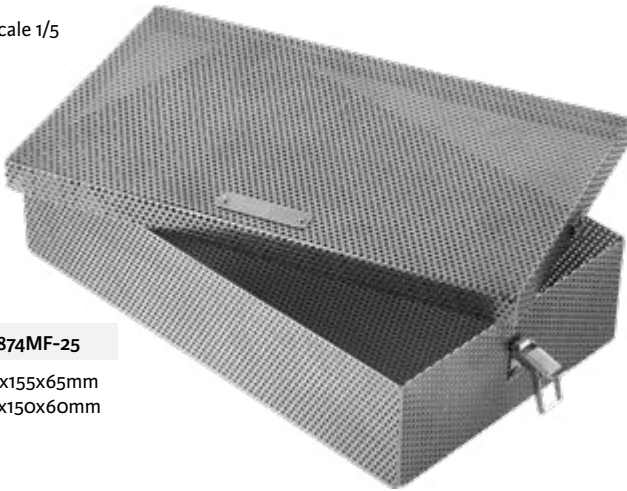

7874MF-25

270x155x65mm
250x150x60mm

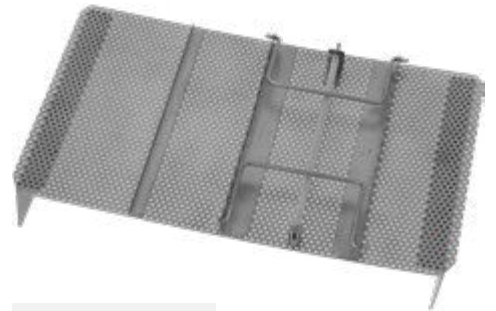

MCO821-1

12 micro instruments

Scale 1/5

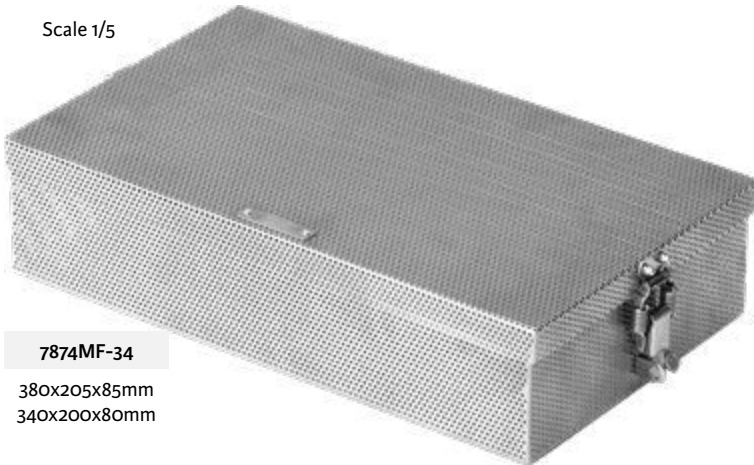

7874MF-34

380x205x85mm
340x200x80mm

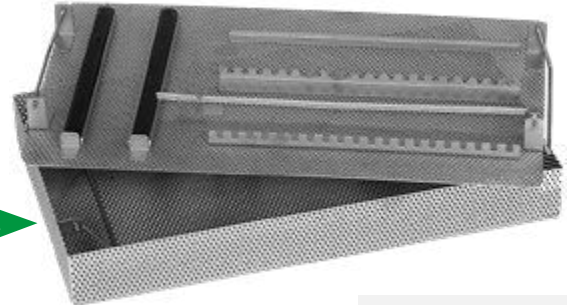

MCO824-1

Set micro instruments

Scale 1/5

7874MF-40

440x205x95mm - 400x200x90mm

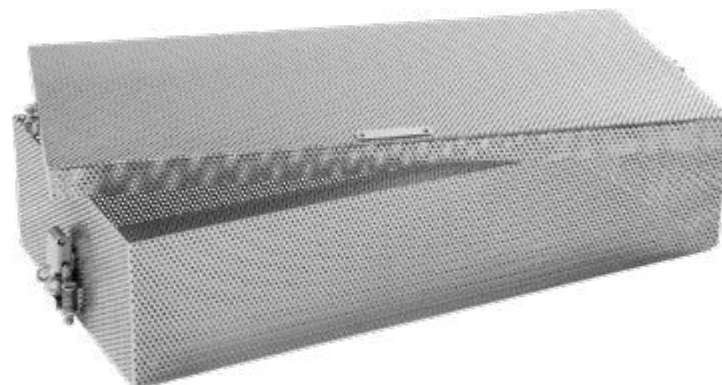

Numerical index

O

O-28	17
O-28-1	17
O-28-2	17
O-28-3	18
O-28-4	18
O-28-7	19
O-28-8	17

1

1003IG ^(D)	7
1003LI ^(D)	7
1004IG ^(D)	7
1005I ^(D)	7
141P23(D)	76
141P27(D)	76
141P31(D)	76
141RS-3-1(D)	76
141RS-4-0(D)	76
141RS-5-0(D)	76
164RS-1-8(D)	76
168RS(D)	76

2

236HM-0-6(D)	76
236HM-0-8(D)	76
236HM-1-0(D)	76
236HM-1-4(D)	76
236HM-1-8(D)	76
236HM-2-3(D)	76
236HM-2-7(D)	76
236HM-3-5(D)	76
236HM-4-0(D)	76
236HM-4-5(D)	76
236HM-5-0(D)	76
236HM-7-0(D)	76
236HM30(D)	76
242-0-6(D)	76
242-0-7(D)	76
242-0-8(D)	76
242-1-0(D)	76
242-1-4(D)	76
242-1-8(D)	76
242-2-3(D)	76
242-2-7(D)	76
242-3-1(D)	76
242-3-5(D)	76
242-4-0(D)	76
242-4-5(D)	76
242-5-0(D)	76
242-6-0(D)	76
242-7-0(D)	76
2035512C4 ^(D)	76
2035515C4 ^(D)	76

3

3714027	16
3714028	16
3722001	63
3722002	63
3722020	64
3722021	64
3722031	65
3722035	65
3722142	64
3722150	5
3722151	5
3724059	14
3724287	65
3724291	65
3724293	66

7

702T	35
703T	35
704T	35
714T	35
7718	3
7719-2	2
7721-1	5
7725	5
7725P1	5
7725P2	5
7725P3	5
7726MF	11
7727	11
7728	11
7731	2
7732-1	11
7733	11
7734	11
7764	24
7766	21
7768	15
7768-1	15
7779MF-1	12
7779MF-2	12
7779MF-3	12
7779MF-5CC	12
7781	20
7782-1-2	16
7783-12	12
7787-10	14
7831A-12	30
7831A-15	32
7833A-12	30
7833A-15	32
7866-13	39
7867-1	36
7867-2	36
7867-3	36
7867-4	36
7872-24(D)	77
7874MF-22	68, 76, 78

7874MF-25	69, 78
7874MF-34	60, 61, 78
7874MF-40	78
7875(D)	4
7876-60(D)	77
7876-80(D)	77
7876-100(D)	77
7876-120(D)	77
7876-160(D)	77
7885	3
7885A	3
7886	3
7888	3
7897	9
7898	9
7899	9
7903-50-5(D)	12

8

8812-1	8
8812-2	8
8812-3	8
8812-4	8
8812-5	8
8814T1	8
8814T2	8
8814T3	8
8814T4	8
8814T5	8

9

9912-7(D)	8
9912-8(D)	8
9912-9(D)	8
9913-1(D)	8
9913-2(D)	8
9913-3(D)	8
9913-4(D)	8
9913-5(D)	8
9913-6(D)	8

CEV

CEV984	10
CEV985	10

CP

CP16	26
CP16-1	26
CP17	15
CP17-1	15
CP17-2	15
CP17-3	15
CP21-3	16
CP21A-3	16
CP37	30
CP85AL	59

CP85AR	59
CP85L	59
CP85R	59
CP300	22
CP302-2	50
CP302-3	50
CP302-4	50
CP302-5	50
CP302-6	50
CP302-8	50
CP330-3-0	40
CP330-4-0	40
CP332	30
CP335	16
CP351-2	28
CP351-3	28
CP351-6	28
CP351-7	28
CP352	29
CP352-1	29
CP352-2	29
CP352-3	29
CP353	26
CP354	26
CP354A	26
CP356	26
CP358	26
CP358A	26
CP363	27
CP380	25
CP380-1	25
CP380-2	25
CP380-3	25
CP380-5	25
CP390-1	34
CP390-2	34
CP390-8	34
CP391E	34, 54
CP391M	34, 54
CP391V	34, 54
CP392-1R	33
CP392-2R	33
CP392-8R	33
CP392BI	33
CP392BS	33
CP393-2	33, 54
CP393-3	33, 54
CP393-4	33, 54
CP400	32
CP400-1	30
CP406	30
CP407	32
CP414	30
CP415	32
CP604	31
CP604-15	31
CP604BR	33
CP604M	34
CP605	31
CP605-15	31
CP605BR	33

^(D) Distributed by Integra MicroFrance SAS (France) - For corresponding manufacturer part numbers, see table in annex

CP605M 34	MCO2 48	MCO21A 45	MCO226C 52
CP606 31	MCO3Po5 43	MCO21B 45	MCO233 9
CP606-15 31	MCO3Po7 43	MCO21C 45	MCO237 9
CP606A 31	MCO3P10 43	MCO21D 45	MCO240 49, 67
CP609 16	MCO3P12 43	MCO21G 45	MCO250 57
CP611 13	MCO3P15 43	MCO21H 45	MCO251 57
CP625 13	MCO3P18 43	MCO21I 45	MCO255 57
CP626 13	MCO3P20 43	MCO22 44	MCO270 46
CP627 13	MCO3P24 43	MCO23 44	MCO271 46
CP628 15	MCO3T-0-5 68	MCO23A 44	MCO272 46
CP637 27	MCO3T-0-7 68	MCO23B 44	MCO290 54
CP801-7 23	MCO3T-1-0 68	MCO25 47	MCO291 54, 75
CP801-10 23	MCO3T-1-2 68	MCO25H 47	MCO301 73
CP821 7	MCO4 45	MCO26 47	MCO302 73
CP821B 6	MCO4A 45, 60, 61	MCO27 46, 60, 61	MCO303 73
CP821C 6	MCO4B 45	MCO29 58	MCO304 73
CP821D 6	MCO4C 45	MCO29-1 58	MCO305 13
CP821E 6	MCO4D 45	MCO31 51	MCO309 72
CP822-10 15	MCO4E 45	MCO32 51	MCO310 72
CP822-12 15	MCO5 48	MCO34 55	MCO311-1-0 41
CP822-14 15	MCO5A-1-0 48	MCO35 68	MCO311-1-2 41
CP823-5 23	MCO5A-1-5 48	MCO36 68	MCO311-1-5 41
CP824-5 23	MCO5A-2-0 48	MCO37 49	MCO311-1-8 41
CP825 14	MCO5A-2-5 48	MCO37-1 49	MCO311-2-0 41
CP907 22	MCO5B 48	MCO37D 49	MCO311-2-5 41
CP919 26	MCO5C 48	MCO37G 49	MCO311-3-0 41
CP919A 26	MCO5D 48	MCO38 55	MCO311-3-5 41
CP922 27	MCO5E 48	MCO201-2-5 40	MCO311-4-0 41
CP922A 27	MCO6 48	MCO201-3-0 40	MCO312 48
CP922B 27	MCO6A 52	MCO204C 48	MCO313 48
CP931 28	MCO6B 52	MCO205 52	MCO318 72
CP931-1 28	MCO6C 48	MCO205A 52	MCO319 72
CP933-14 32	MCO6M 73	MCO205B 52	MCO320 73
CP934 32	MCO7-1 50	MCO205C 52	MCO321 73
CP934-1 32	MCO7-3 50	MCO205D 52	MCO322 73
CP938-1 30	MCO7A-1 50	MCO207-1-5 50	MCO330MO 73
CP941 15	MCO7A-3 50	MCO207-2-0 50	MCO333 73
CP985 13	MCO7A-5 50	MCO209 53	MCO337DL 73
CP988-15 32	MCO7A6 50	MCO210 49	MCO337DR 73
CP1107 35	MCO7AMO 73	MCO213-4 58, 60, 61	MCO340 73
	MCO8 49	MCO213-6 58	MCO341 73
	MCO8B 49	MCO214-13-10 23	MCO342 73
	MCO8BM 54	MCO214-13-20 23	MCO343 73
	MCO9 53	MCO214-13-40 23	MCO351 72, 75
	MCO9-1 53, 67	MCO214-13-60 23	MCO352-20 71
	MCO10 48	MCO214-13-80 23	MCO352-25 71
	MCO10B 48	MCO215 48	MCO352-30 71
	MCO10M 48	MCO216-3-5 49	MCO352E20 71
	MCO10MO 73	MCO218-4 58	MCO352E25 71
	MCO12B 55	MCO218-6 58	MCO352N20 71
	MCO12D 55, 60	MCO218-8 58	MCO352N25 71
	MCO12E 55, 60, 61	MCO221 51	MCO354 71
	MCO12H 55, 60, 61	MCO221A 51	MCO357A 72
	MCO12R 55	MCO221MO 73	MCO366F10 43
	MCO13A 44	MCO222 46	MCO366F12 43
	MCO13B 44	MCO224-2-0 49	MCO366F15 43
	MCO13C 44, 60, 61	MCO224A-2-0 49	MCO366F20 43
	MCO13D 44	MCO224G 73	MCO367F10 71
	MCO13E 44	MCO226 52	MCO367F12 71
	MCO17 44	MCO226A 52	MCO367F15 71
	MCO21 45	MCO226B 52	MCO367F20 71

M

M832 31
M833 31

MCEN

MCEN23-2-5 41
MCEN23-3-0 41
MCEN770j30 40
MCEN770j40 40

MCL

MCL359 20

MCO

MCO1B 41

^(D) Distributed by Integra MicroFrance SAS (France) - For corresponding manufacturer part numbers, see table in annex

^(D) Distributed by Integra MicroFrance SAS (France) - For corresponding manufacturer part numbers, see table in annex





**Table for corresponding
manufacturer part numbers
For information purposes only**

Integra MicroFrance® product reference	Corresponding manufacturer part number	Integra MicroFrance® product reference	Corresponding manufacturer part number
1003IG	M3IG	7876-100	310
1003LI	M3LI	7876-120	312
1004IG	M4IG	7876-160	316
1005I	M5I	7876-60	306
141P23	41R3F1C923	7876-80	308
141P27	41R3F1C927	7903-50-5	13.202
141P31	41R3F1C931	9912-7	6617-7
141RS-3-1	39141RF106031	9912-8	6617-8
141RS-4-0	39141RF106040	9912-9	6617-9
141RS-5-0	39141RF106050	9913-1	6611
164RS-1-8	39164RF104018	9913-2	6612
168RS	39168RF105023	9913-3	6613
2035512C4	41L3A16120	9913-4	6614
2035515C4	41L3A16150	9913-5	6615
236HM-0-6	2900236106006	9913-6	6616
236HM-0-8	2900236106008	MCO702-22	580911D104220
236HM-1-0	2900236106010	MCO731	430490
236HM-1-4	2900236106014	SM63	SM63
236HM-1-8	2900236106018	SM64	SM64
236HM-2-3	2900236106023	SM65	SM65
236HM-2-7	2900236106027		
236HM30	2900236106030		
236HM-3-5	2900236106035		
236HM-4-0	2900236106040		
236HM-4-5	2900236106045		
236HM-5-0	2900236106050		
236HM-7-0	2900236106070		
242-0-6	59LH242106006		
242-0-7	59LH242106007		
242-0-8	59LH242106008		
242-1-0	59LH242106010		
242-1-4	59LH242106014		
242-1-8	59LH242106018		
242-2-3	59LH242106023		
242-2-7	59LH242106027		
242-3-1	59LH242106031		
242-3-5	59LH242106035		
242-4-0	59LH242106040		
242-4-5	5900242106045		
242-5-0	59LH242106050		
242-6-0	59LH242106060		
242-7-0	5900242106070		
7872-24	1224		
7875	1724		

Manufacturers :



Integra MicroFrance SAS (France)
Le Pavillon ■ 03160 Saint Aubin le Monial ■ France



Hager & Meisinger GmbH
Hansenmannstrasse 10
D- 41468 Neuss ■ Allemagne



Swann Morton Ltd
Penn Works ■ Owlerton Green ■ Sheffield
South Yorkshire S6 2BJ ■ Royaume Uni

Manufacturers with CE Class I products only



FFDM - Pneumat
78/80 Avenue de la Prospective
18020 Bourges ■ France



Chemische Fabrik Dr. Weigert GmbH & Co.
Mühlenhagen
D-20539 Hamburg ■ Allemagne



Unimed SA
Rue du Grand-Pré 10
1007 Lausanne ■ Suisse



Concorde Import Export
B.P. 37
92300 Levallois-Perret ■ France



Agencinox
Zone Industrielle
89110 Aillant sur Tholon ■ France

Availability of these products might vary from a given country or region to another, as a result of specific local regulatory approval or clearance requirements for sale in such country or region.

- Consult product labels and inserts for any indications, contraindications, hazards, warnings, precautions, and instructions for use.
- Non contractual document. The manufacturer reserves the right, without prior notice, to modify the products in order to improve their quality.
- Warning: Applicable laws restrict these products to sale by or on the order of a physician.

Additional information for EMEA Customers only :

Products mentioned in this document are CE class I, Im, IIa or IIb devices. Contact Integra should you need any additional information on devices classification. All the medical devices mentioned on this document are CE marked according to European council directive 93/42/EEC on medical devices and its relatives. References that are not medical devices are identified with the indication "NOT A MEDICAL DEVICE".

Products marked with the symbol ⁽⁹⁾ are distributed by Integra MicroFrance SAS (France)

Date of last revision : 12/2020

For more information, please contact customer service :

Europe, Middle-East, Africa

International: +33 (0) 437 47 59 50 ■ +33 (0) 437 47 59 25 (Fax) ■ csema@integralife.com
France: +33 (0) 437 47 59 10 ■ +33 (0) 437 47 59 29 (Fax) ■ custservfrance@integralife.com
United Kingdom: +44 (0) 1264 312 725 ■ +44 (0) 1264 312 821 (Fax) ■ custsvcs.uk@integralife.com
Belgium & Luxembourg: +32 (0)2 257 4130 ■ +32 (0)2 253 2466 (Fax) ■ custsvcbenelux@integralife.com
Netherlands: +31(0) 852 083 167 ■ +31(0) 207 093 627 (Fax) ■ custsvcnetherlands@integralife.com
Italy: +39 (0)2 577 8921 ■ +39 (0)2 575 113 71 (Fax) ■ custsvcitaly@integralife.com
integralife.eu/contact

Integra and the Integra logo are registered trademarks of Integra LifeSciences Corporation or its subsidiaries in the United States and/or other countries.

MicroFrance is a trademark of Integra LifeSciences Corporation or its subsidiaries.
All other trademarks and product names are the property of their respective owners.

© 2020 Integra LifeSciences Corporation. All rights reserved.

0328571-4-EN

DOCUMENT FOR USE IN EUROPE, MIDDLE-EAST AND AFRICA ONLY.