

## **Integra<sup>®</sup> MicroFrance<sup>®</sup>**

Catalogue Integra ORL

Chirurgie plastique

<b>Table des matières</b>	ii	<b>Ciseau gouge</b>	21
<b>Service Client et Garanties</b>	iv	<b>Ostéotome</b>	22
<b>Indications / Contre-indications</b>	v	Ostéotome courbe	22
<b>Spéculum à manche</b>	2	Ostéotome droit	22
Câble à lumière froide	2	<b>Ostéotome boutonné</b>	23
Raccords câble à lumière froide	2	<b>Ostéotome boutonné des 2 côtés</b>	24
Spéculum à lumière froide	2	<b>Ostéotome fin</b>	25
Spéculum à manche autostatique	2	Ostéotome boutonné d'un coté courbe	25
<b>Pince à disséquer coudée</b>	3	Ostéotome boutonné d'un coté droit	25
Pince mors à griffes	3	Ostéotome droit gradué	25
Pince mors curettes	3	Ostéotome très courbe	25
Pince mors lisses	3	<b>Ostéotome divers, Curette droite</b>	26
Pince mors striés	3	<b>Râpe droite</b>	27
<b>Seringue</b>	4	<b>Râpe courbe</b>	28
Aiguille à injection	4	<b>Râpe double 210 mm</b>	29
Corps de seringue	4	<b>Râpes diverses</b>	30
Joint pour seringue	4	<b>Attelle, Plaque moule, Presse-greffe, Perforateur à os</b>	31
Pousse-seringue	4	<b>Pince gouge double articulation</b>	32
Seringue	4	<b>Pince coudée</b>	33
<b>Décolleur - Rugine</b>	5 - 6	<b>Pince coupante à os</b>	34
<b>Décolleur aspirateur</b>	7 - 8	<b>Pince septum</b>	35
Jankowski	8	<b>Ciseaux pointus courts</b>	36
Lempert	8	<b>Ciseaux pointus longs</b>	37
Micro aspirateur irrigateur à soupape	8	<b>Ciseaux mousses courts</b>	38
Wertheimer	8	<b>Ciseaux mousses courbes longs</b>	39
<b>Bistouri - Scalpel</b>	9	<b>Ciseaux de Metzenbaum</b>	40
<b>Bistouri</b>	10	<b>Ciseaux de Mayo</b>	41
Bistouri coudé	10	<b>Ciseaux angulés</b>	42 - 43
Bistouri droit	10	<b>Ciseaux crantés</b>	44 - 45
Couteau	10	Ciseaux coudés sur le champ	45
<b>Rugine</b>	11 - 12	Ciseaux droits lames baïonnettes crantées	44
Rugine courbe	11, 12	Ciseaux droits lames crantées	44
Rugine courbe tranchante	12	Ciseaux lames crantées tungstènes coupe fil d'acier	44
Rugine droite	12	<b>Pince à disséquer fine</b>	46
<b>Ecarteur</b>	13 - 18	Pince à griffes et plateaux	46
Crochet mousse	14	Pince mors à griffes	46
Crochet pointu	13, 14	Pince mors striés	46
Ecarteur à griffes	15		
Ecarteur double	13, 16		
Ecarteur double mousse	18		
Ecarteur mousse	13, 17		
Ecarteur mousse 2 griffes	18		
Ecarteur pointu	17		
Ecarteur pointu articulé	13		
<b>Maillet</b>	19		
<b>Ciseau burin droit - Ciseau gouge droit</b>	20		

<b>Pince à disséquer Adson</b>	47	<b>Ouvre-bouche complet</b>	71
<b>Autre pince à disséquer fine</b>	48	<b>Lame malléable écarteur - Ecarteur double</b>	72
Pince à griffes et plateaux	48	Ecarteur à lambeaux	72
<b>Pince à disséquer moyenne</b>	49 - 50	Ecarteur double	72
Pince à griffes et plateaux	49, 50	Lame malléable écarteur	72
Pince mors à griffes	49	<b>Maxillaire</b>	73 - 74
Pince mors striés	49, 50	Bistouri crochet	74
<b>Pince à disséquer 180 mm</b>	51	Crochet pointu	73
<b>Pince à disséquer 200 mm</b>	52	Décolleur courbe	74
<b>Pince à disséquer bipolaire moyenne</b>	53	Ecarteur à condyle	73
Câbles bipolaires	53	Fraise forêt à fissure	73
Pince mors à griffes	53	Ostéotome courbe	74
Pince mors lisses	53	Passe-fil courbe aiguille mandibulaire	74
Pince mors striés	53	Pince à expansion	73
<b>Pince à disséquer bipolaire 200 mm</b>	54	Rugine courbe	74
<b>Pince à disséquer monopolaire moyenne</b>	55	<b>Ciseaux lames baïonnettes petits</b>	75
<b>Pince à disséquer monopolaire longue</b>	56	<b>Ciseaux lames baïonnettes grands</b>	76
<b>Porte-aiguille mors tungtène</b>	57 - 58	<b>Ciseaux à lifting</b>	77
<b>Porte-aiguille mors tungstène long</b>	59	<b>Lifting</b>	78 - 79
<b>Pince hémostatique fine</b>	60	Ecarteurs à lifting	79
<b>Pince hémostatique moyenne</b>	61	Pincés à griffes à lifting	78
<b>Pince hémostatique striée</b>	62	<b>Seins</b>	80 - 81
<b>Pince à griffes forte</b>	63	<b>Panier, cupule, lubrifiant</b>	82
<b>Otoplastie</b>	64	<b>Index numérique</b>	83
<b>Micro chirurgie</b>	65 - 66	<b>Tableau d'équivalence à titre informatif</b>	89
<b>Instruments de Gilbert, Set de la main</b>	67 - 68		
<b>Instruments de Gilbert, Set Os</b>	69 - 70		

## Garantie limitée d'Integra

Pour connaître les garanties applicables, merci de vous référer aux garanties précisées dans l'emballage de chaque produit.

## Contacts Services Clients :

### International

+33 (0) 4 37 47 59 50  
+33 (0) 4 37 47 59 25 (fax)  
csemea@integralife.com

### France

+33 (0) 4 37 47 59 10  
+33 (0) 4 37 47 59 29 (Fax)  
custservfrance@integralife.com

### Belgique & Luxembourg

+32 (0) 2 257 4130  
+32 (0) 2 253 2466 (Fax)  
custsvcbenlux@integralife.com

### Royaume-Uni

+44 (0) 1264 312 725  
+44 (0) 1264 312 821 (Fax)  
custsvcs.uk@integralife.com

### Pays-Bas

+31 (0) 852 083 167  
+31 (0) 207 093 627 (Fax)  
custsvcnetherlands@integralife.com

### Italie

+39 (0) 2 577 8921  
+39 (0) 2 575 113 71 (Fax)  
custsvitaly@integralife.com



## Instrumentation O.R.L. MicroFrance®

### INDICATIONS

- Tous les dispositifs médicaux présentés dans ce catalogue sont indiqués pour les consultations ORL et/ou la chirurgie ORL.
- Les dimensions présentes dans ce document ne sont pas contractuelles et sont données à titre indicatif seulement.

### CONTRE-INDICATIONS

- Ne pas utiliser dans d'autres indications que celles prévues (mentionnées) dans la notice d'instructions ou l'étiquetage.

### Explications sur la présentation de ce catalogue

Titre et/ou famille produit

Ostéotome boutonné

INTEGRA  
LIMIT UNCERTAINTY

Tessier    Jost    Marchac    Claoué    Silver

Pech-Marchac    Lindas

180mm    180mm    180mm    180mm    180mm

CP316    CP302    CP315    CP305    3714098

CP315    CP305    CP305L à droite    CP305L à gauche    3714098 à droite

CP315G à gauche    CP305R à droite    3714099 à gauche

DOCUMENT DESTINÉ A L'EUROPE, AU MOYEN-ORIENT ET A L'AFRIQUE

23

Représentation de l'instrument à l'échelle 1/1 sauf indications contraires

Tableau explicatif voir ci-dessous

Vue détaillée de l'instrument

### Explications sur le tableau référence produit et description complémentaire

Titre ou sous titre ou Longueur	
description complémentaire globale (option)	
Réf. produit1	description complémentaire1
Réf. produit2	description complémentaire2



Spéculum à lumière froide - Câble à lumière froide 220cm - Raccords



<sup>(1)</sup> Produit non dispositif médical

<sup>(D)</sup> Distribué par Integra MicroFrance SAS (France) - Voir tableau d'équivalence annexe pour la référence du fabricant correspondant

**Lucae**



7726MF

150mm

7726MF	7727	7728
mors striés 1x12mm	mors curettes	mors à griffes

**Politzer**



7732-1

120mm

7732-1	7733	7734
mors striés 1,5x14mm	mors curettes	mors à griffes

Seringue

Génia

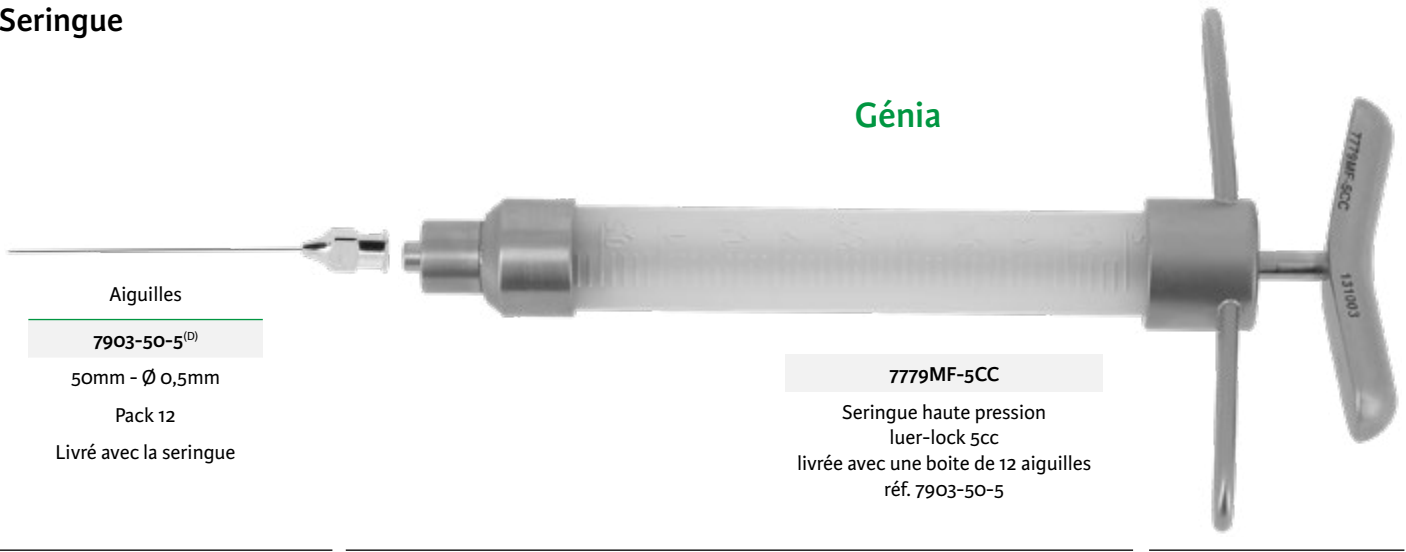

Aiguilles

**7903-50-5<sup>(D)</sup>**

50mm - Ø 0,5mm

Pack 12

Livré avec la seringue

**7779MF-5CC**

Seringue haute pression  
luer-lock 5cc  
livrée avec une boîte de 12 aiguilles  
réf. 7903-50-5

Joint gris embout cône luer

Corps de seringue

Joint blanc piston



**7779MF-2**

Pack 6



**7779MF-3**



**7779MF-1**

Pack 6



Pousse-seringue

**7783-12**

Pack 2



Chouard



pour seringue usage unique luer-lock 12cc

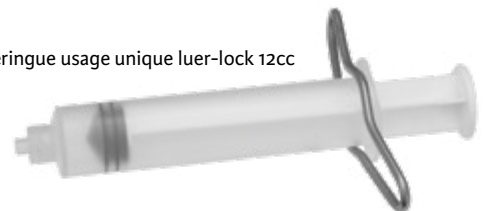

Aiguille à injection



**7903-50-5<sup>(D)</sup>**

50mm - Ø 0,5mm

Pack 12

pour seringue 7779MF-5CC

<sup>(D)</sup> Distribué par Integra MicroFrance SAS (France) - Voir tableau d'équivalence annexe pour la référence du fabricant correspondante

Sébileau

Fleury

Freer

Howarth



190mm

CP985

5mm



180mm

MCO305

8,5mm



160mm

MCO803

2,5mm



185mm

CP611

5mm



220mm

CP625

Cottle



220mm  
CP626

McKenty



240mm  
CP627

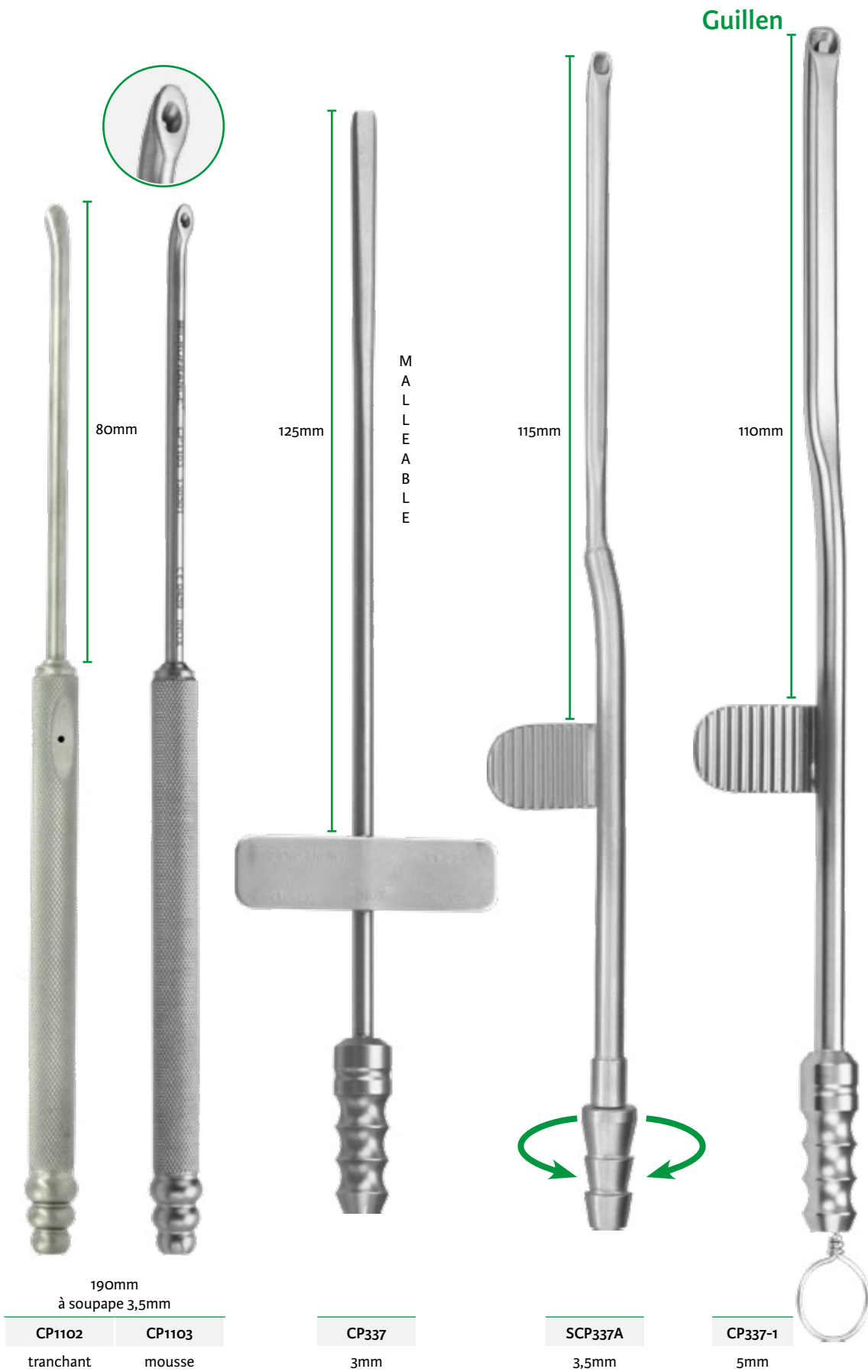

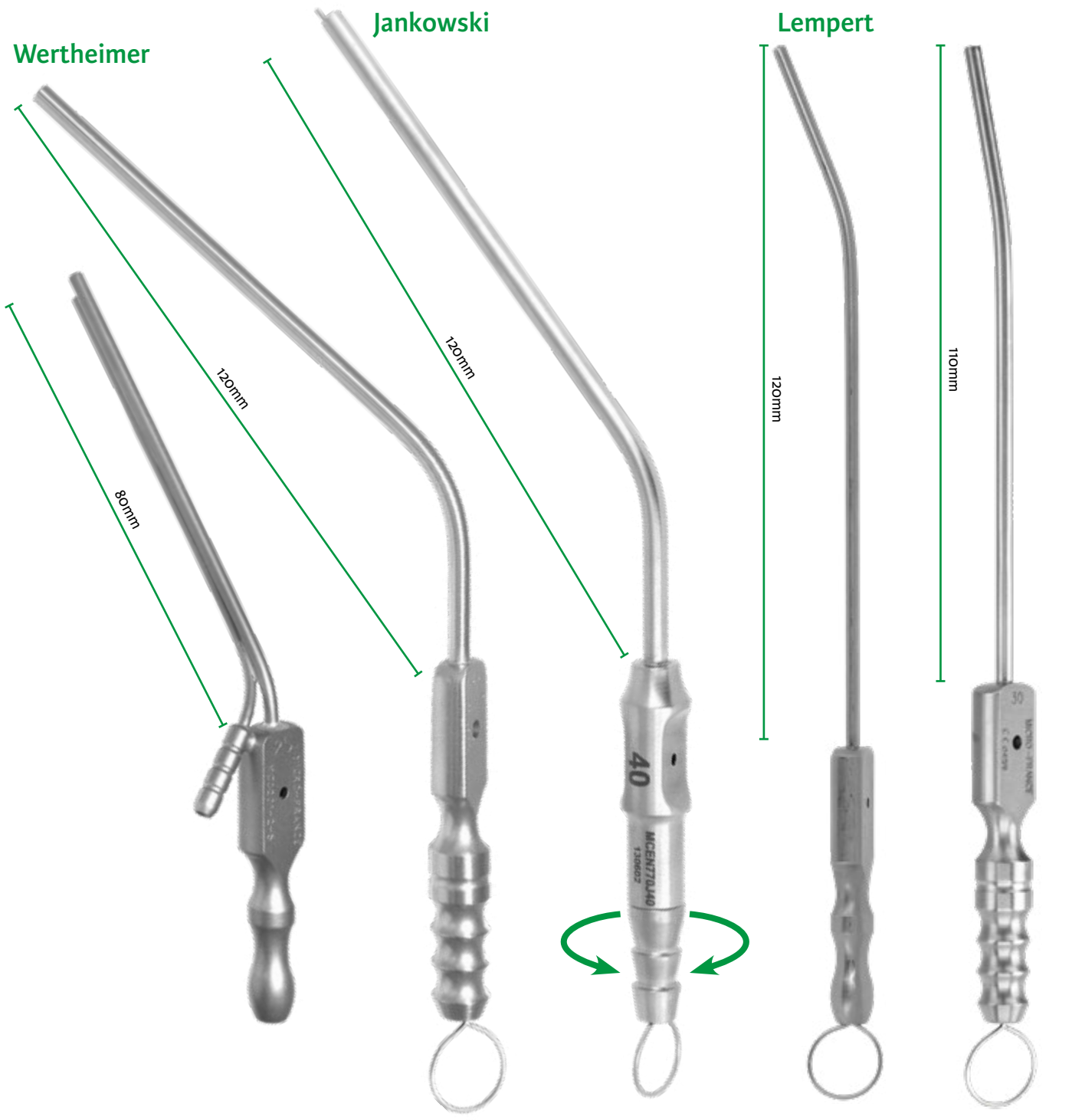

- 1,5mm
- 2mm
- 2,5mm
- 3mm
- 3,5mm
- 4mm

Wertheimer	
MCO201-2-5	2,5mm
MCO201-3-0	3mm

Wertheimer	
MCO770-1-5	1,5mm
MCO770-2-0	2mm
MCO770-2-5	2,5mm
MCO770-3-0	3mm
MCO770-3-5	3,5mm
MCO770-4-0	4mm

Jankowski	
MCEN770J40	4mm
MCEN770J30	3mm

Lempert	
MCO771-2-5	2,5mm
MCO771-3-0	3mm
MCO771-4-0	4mm

Lempert	
CP330-3-0	3mm
CP330-4-0	4mm





120mm

160mm

200mm

150mm

120mm

1003IG<sup>(D)</sup>

1005I<sup>(D)</sup>

1003LI<sup>(D)</sup>

CP821

1004IG<sup>(D)</sup>

N° 3

N° 7

N° 3L

N° 4

utilisation avec lames 11/15

lames 23

<sup>(D)</sup> Distribué par Integra MicroFrance SAS (France) - Voir tableau d'équivalence annexe pour la référence du fabricant correspondante

**Ballenger**



200mm

CP622-4 4mm

215mm

3714164 3mm

3714166 5mm

**Joseph**



160mm

CP333 coudé

**Joseph**



160mm

3714678

7mm

Farabeuf

Fleury

Sébileau

Plester



150mm

7787-10

10mm



170mm

MCO979

6,5mm



150mm

CP825

4mm



180mm

MCO988

7,5mm



195mm

3724059

6,5mm

Joseph

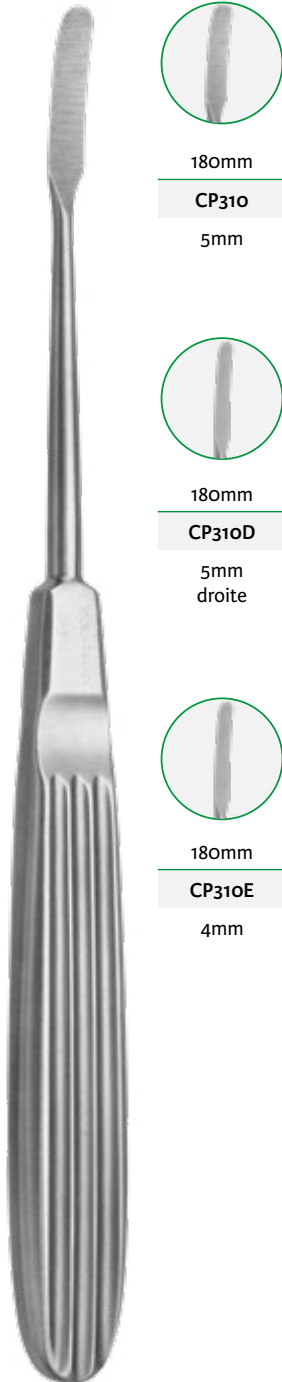

180mm

CP310

5mm



180mm

CP310D

5mm  
droite



180mm

CP310E

4mm

CP310

Obwegeser



Obwegeser

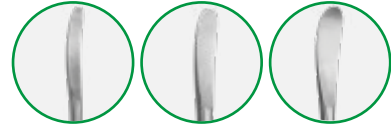

180mm

CP344A

5mm

CP344B

7mm

CP344C

11mm

Obwegeser-Tessier

180mm - tranchante

CP344AT

5mm

CP344BT

7mm

CP344CT

11mm

Obwegeser



190mm

CP344D

7mm  
courbe

CP344E

7mm  
très courbe

Obwegeser-Tessier

190mm - tranchante

CP344DT

7mm  
courbe

CP344ET

7mm  
très courbe

CP344A

Farabeuf



140mm 120mm  
7768-1 7768  
la paire la paire

Desmarres



140mm  
CP822-12  
12mm  
CP822-10  
10mm  
CP822-14  
14mm

Gillies



180mm  
CP17  
3mm  
CP17-1  
2mm  
M812A  
2mm mousse

Gillies



145mm  
CP17-3  
2mm  
CP17-2  
3mm



145mm  
CP628  
5mm

Humby



110mm  
CP941  
articulé

Kleinert-Kutz



160mm

3714024	3mm
3714025	5mm
3714026	7mm

Cottle



145mm

3714107	4mm
très courbe	
3714108	4mm
3714109	5mm

Sisson



150mm

3714111	6mm mousse
---------	---------------

Converse



180mm

3714364	2,5mm
---------	-------

Frazier



130mm

3724256	3,5mm
---------	-------

Knapp



150mm

3714027

8mm

3714028

mousse

Volkmann



140mm

CP21-3

pointu

CP21A-3

mousse



150mm

7782-1-2



180mm

CP335

Senn-Miller



160mm

CP609

3 griffes pointues

80mm  
CP340

**Claoué**



110mm  
CP341

**Converse**



95mm  
CP331 CP331-1  
pointu mousse

**Kilner**



125mm  
CP803

**Jost**



120mm  
CP338



130mm  
CP339





Aufricht



170mm

CP306 45mm

Cottle



130mm

3714187

Cottle



3714182

130mm

3714182 pointu à droite  
boule à gauche

3714183 pointu à gauche  
boule à droite

Joseph



CP23-4

4mm



CP23-6

6mm



CP23-8

8mm



CP23A-8

8mm  
mousse



CP23-10

10mm

160mm

CP23-10

10mm

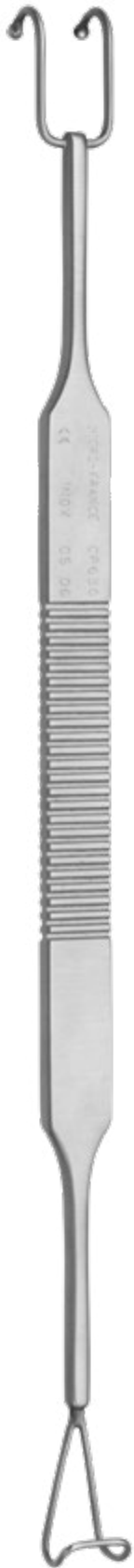

220mm

CP630

Anse et boule

### Ragnell



145mm

CP632

### Dufourmentel



170mm

CP947

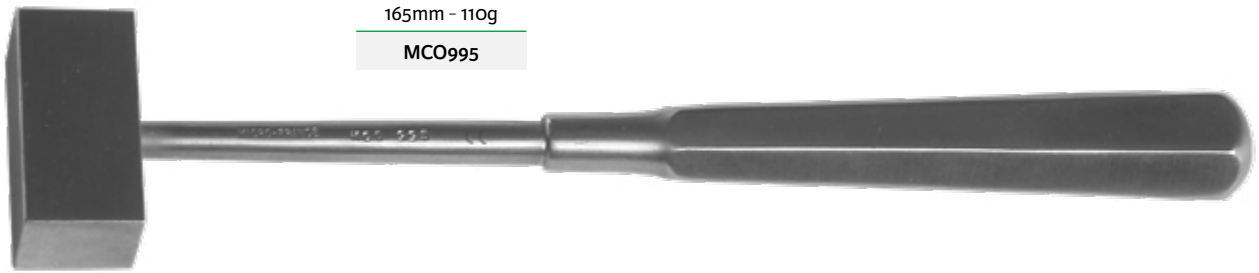

165mm - 110g

MCO995



Lombard

185mm - 330g

7766



180mm - 200g

CP907

1 face téflon



180mm - 230g

CP300

**Jost**



Ciseau burin  
droit  
180mm

CP801-7	7mm
CP801-10	10mm

**Fleury**

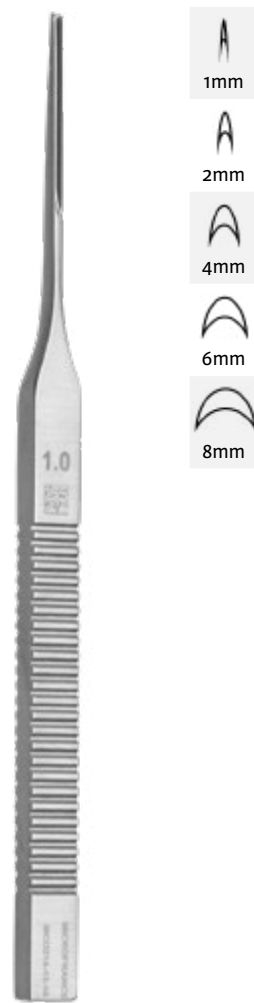

Ciseau gouge  
droit  
130mm

MCO214-13-10	1mm
MCO214-13-20	2mm
MCO214-13-40	4mm
MCO214-13-60	6mm
MCO214-13-80	8mm

**Ballenger**

**Metzenbaum**



droit en V  
150mm

3714055	2mm
3714056	4mm
3714057	6mm
3714058	8mm

droit en V  
150mm

3714320	5mm
---------	-----

baïonnette  
150mm

CP823-5	5mm
---------	-----

baïonnette en V  
150mm

CP824-5	5mm
---------	-----

**Aiach**



160mm  
CP317  
16mm

**Pollet-Pech**



160mm  
CP318  
13mm

**Marchac**



180mm  
CP304-10

Taille	Courbe	Droit
 2mm	CP304B-2	CP304-2
 3mm	CP304B-3	CP304-3
 4mm	CP304B-4	CP304-4
 5mm	CP304B-5	CP304-5
 6mm	CP304B-6	CP304-6
 7mm	-	CP304-7
 8mm	CP304B-8	CP304-8
 9mm	-	CP304-9
 10mm	CP304B-10	CP304-10
 11mm	-	CP304-11
 12mm	CP304B-12	CP304-12
 14mm	-	CP304-14
 15mm	-	CP304-15
 16mm	-	CP304-16

Tessier

Jost

Marchac

Claoué

Silver



180mm

CP316



180mm

CP802



180mm

CP315



CP315

Pech-Marchac



CP315D

à droite



CP315G

à gauche



180mm

CP305

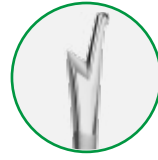

CP305

Lindas

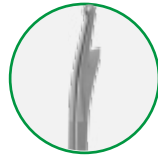

CP305L

à gauche

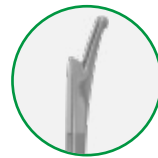

CP305R

à droite



180mm

3714098



3714098

à droite



3714099

à gauche

**Mac-Indoe**



180mm

**CP314-14**

14mm, droit  
lame incurvée

**Robin**



160mm

**CP309-14-16**



**CP309-8-12**

8 - 12mm

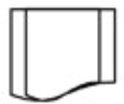

**CP309-10-14**

10 - 14mm

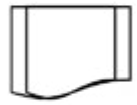

**CP309-12-16**

12 - 16mm



**CP309-14-16**

14 - 16mm



**CP309-14-18**

14 - 18mm



Cottle



195mm  
CP808-6  
6mm

Cottle



195mm  
CP806  
6mm

Cottle



190mm  
CP807  
5mm

Becker

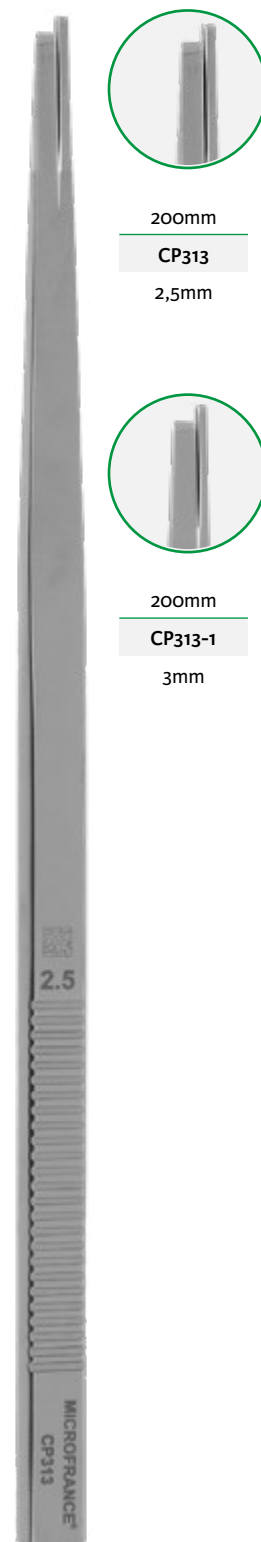

200mm  
CP313

Ostéotome divers

Parkès



170mm

3714096

4mm

Curette droite

Volkman



CP302-6

170mm

- CP302-2 2mm
- CP302-3 3mm
- CP302-4 4mm
- CP302-5 5mm
- CP302-6 6mm
- CP302-8 8mm

Maltz



170mm  
CP301-1

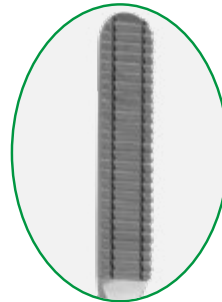

Maltz

CP301-1

8x35mm - en tirant

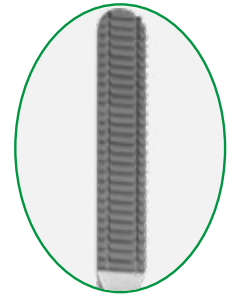

Maltz

CP301

10x45mm - en tirant

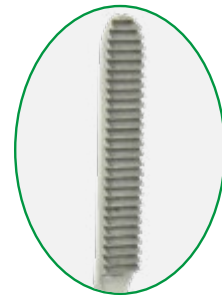

170mm

CP905

8x35mm, concave

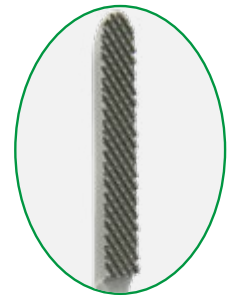

170mm

CP828

8x35mm - en tirant



170mm

CP978

8x35mm, droite, grain d'orge

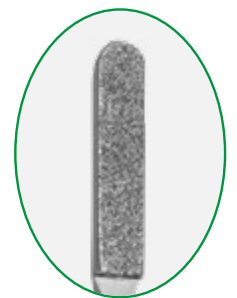

180mm

CP810

8x30mm, droite, diamantée

**Aufricht**



200mm  
CP1100  
8x8mm

200mm



CP973  
8x25mm  
en tirant



CP974  
8x25mm  
en poussant

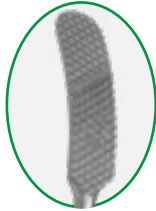

CP976  
8x30mm  
double action



200mm  
CP291  
4x15mm

**Bigot**



190mm  
CP998-1  
8x12mm  
transversale

**Fomon**



180mm  
CP301-2  
8x30mm  
en tirant

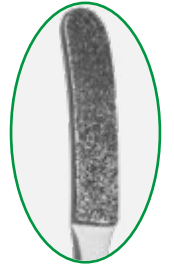

180mm  
CP809  
8x30mm  
Diamantée



175mm  
CP301-3  
7x20mm  
concave  
en tirant

Becker

Becker

Fomon

Rees

Gorney



CP301-10  
7x38mm  
7/8



CP1104  
7x20mm  
1/2



CP1105  
7x20mm  
3/4



CP301-4  
7x38mm  
grain d'orge



CP301-5  
7x38mm

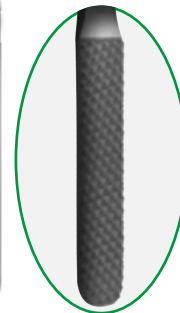

CP301-9  
7x12mm  
8x22mm



Fomon



210mm

Râpe double  
gros grains d'orge

3714149 7mm

petits grains  
d'orge

3714148 7mm

3714149

**Aquaplast™**

Echelle 1/2

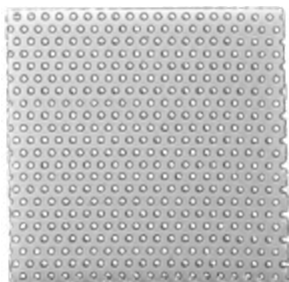

**AQ1728<sup>(D)</sup>**

75x75mm - Pack 10  
non stérile, usage unique

**Plaque moule avec graduation**

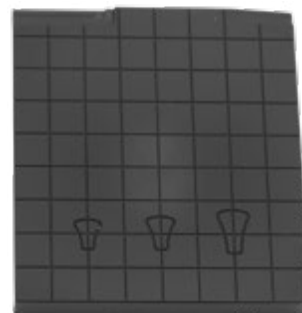

**CP1109**

80x90mm  
avec graduations

<sup>(D)</sup> Distribué par Integra MicroFrance SAS (France) - Voir tableau d'équivalence annexe pour la référence du fabricant correspondante

**Jost**



**CP814-1**

Livré avec clé CP814-3



**CP814-2**

Plaque lisse 30x50mm  
pour CP814-1



**CP814-3**

Clé de serrage seule  
pour CP814-1

**Presse-greffe écraseur à cartilage**

**Perforateur à os**



**Stoll**

150mm

**CP640**

**Beyer**



CP380

160mm

CP380	CP380-2
mors droits 2mm	mors courbes 2mm

**Beyer**



CP380-3

180mm

CP380-3	CP380-5	CP380-1
mors courbes 2mm	mors courbes 4mm	mors droits 2mm



## Jansen-Middleton



180mm

Pince gouge coudée  
double articulation

CP621 4x20mm

**Pince coupante double articulation**

Echelle 2/3



**Ruskin**

160mm

CP381

## Martin



240mm

7765

livré avec 2 mors

**Streiff**



CP16-1

105mm

CP16-1 CP16

lames courbes lames droites

Echelle 3/4

**Offret**



100mm

CP356

100mm

CP353

forte courbure

**Joseph**



CP354A

120mm

CP354A CP354

lames courbes lames droites

**Joseph**



CP919A

110mm

CP919A CP919

lames courbes lames droites

**Fox**



CP358A

110mm

CP358A CP358

lames courbes lames droites

**Kilner-jost**



120mm

CP362

Courbe

**Boetcher**



180mm

CP997

Courbe

**Brophy**



CP367-1

150mm

CP367-1

CP367

Courbe

Droit

**Joseph**



CP355A

150mm

CP355A

CP355

Courbe

Droit

**Bregat**

Finition mat



110mm

**CP363**

lames courbes

**Stevens**

Finition mat



110mm

**CP922**

lames droites

**Stevens**

Finition mat



110mm

**CP922A**

lames courbes

**Stevens**

Finition mat



115mm

**CP922B**

lames courbes modèle «Angers»

**Shea**

Finition mat



120mm

**CP637**

lames courbes

Reynolds

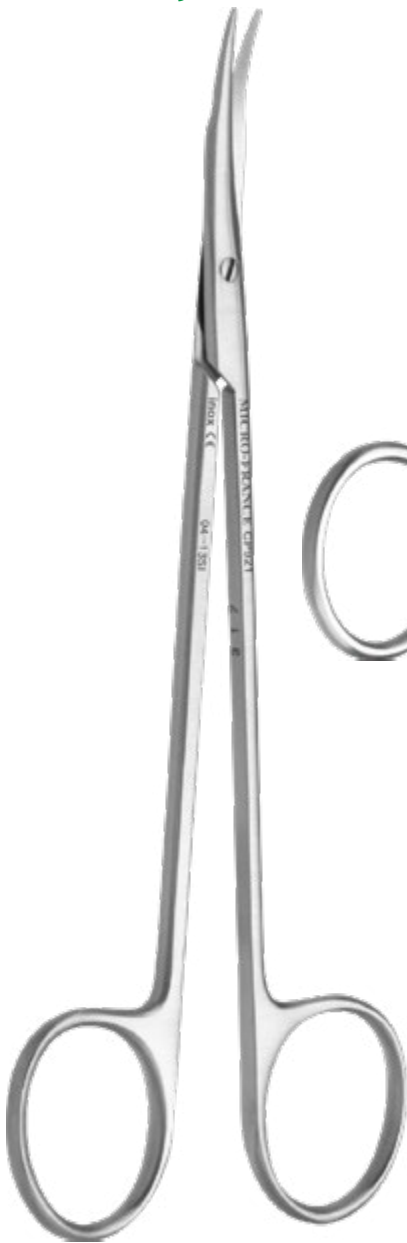

160mm

CP921

Ragnell



150mm

CP616-15

130mm

CP616-13

Joseph



140mm

CP355C

Léger



140mm

CP365



CP351-7

110mm

CP351-7	CP351-6
lames courbes	lames droites



CP351-5



CP931-5

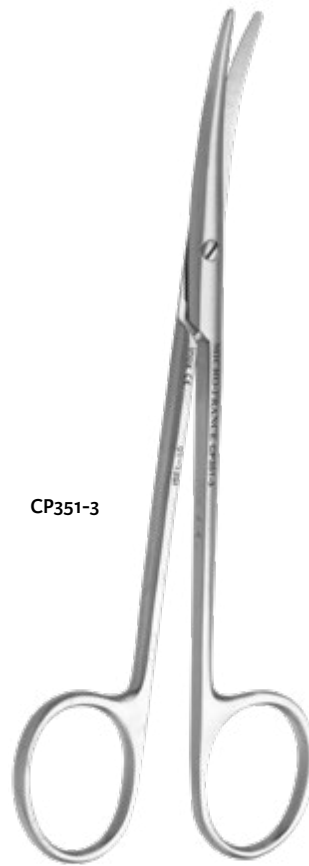

CP351-3

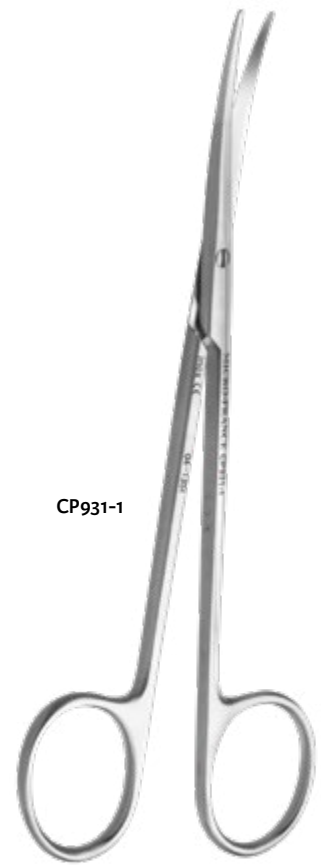

CP931-1

Courbe standard

CP351-5	CP351-1
200mm	180mm

Courbe modèle fin

CP931-5	CP931-3
200mm	180mm

150mm

CP351-3	CP351-2
lames courbes	lames droites

150mm - lames fines

CP931-1	CP931
courbes	droites



finition mat



**Becker-Converse**

100mm

CP1106

lames crantées



**Converse**

100mm

CP348



**Fomon**

140mm

CP612

très courbes



**Fomon**

140mm

CP613

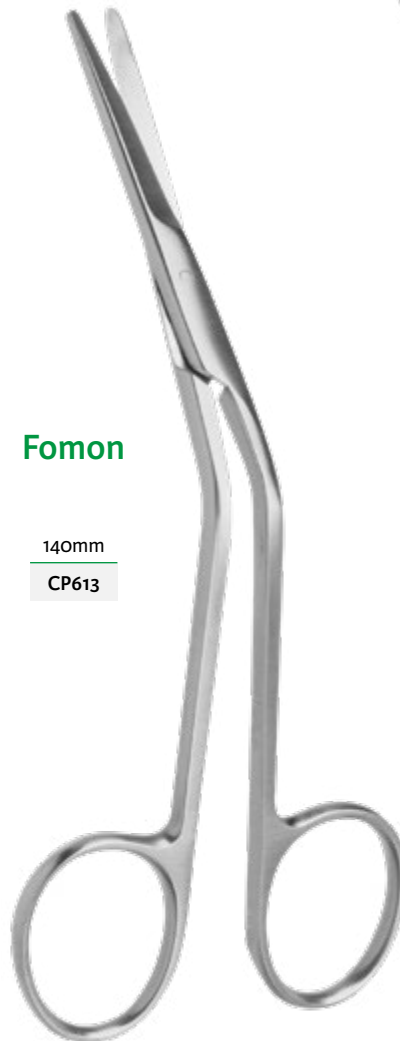

**Cottle-Pech**

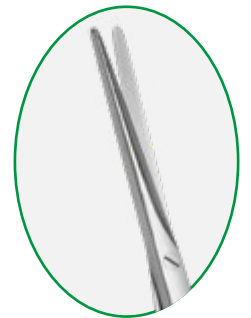

140mm

CP635

### Cottle

150mm  
CP614



### Pellegrini

150mm

CP359

lames crantées

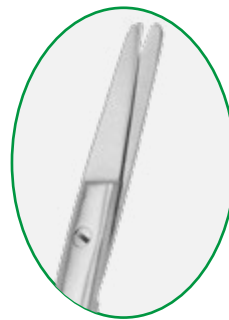



180mm  
**CP350**  
Droits  
lames baïonnettes

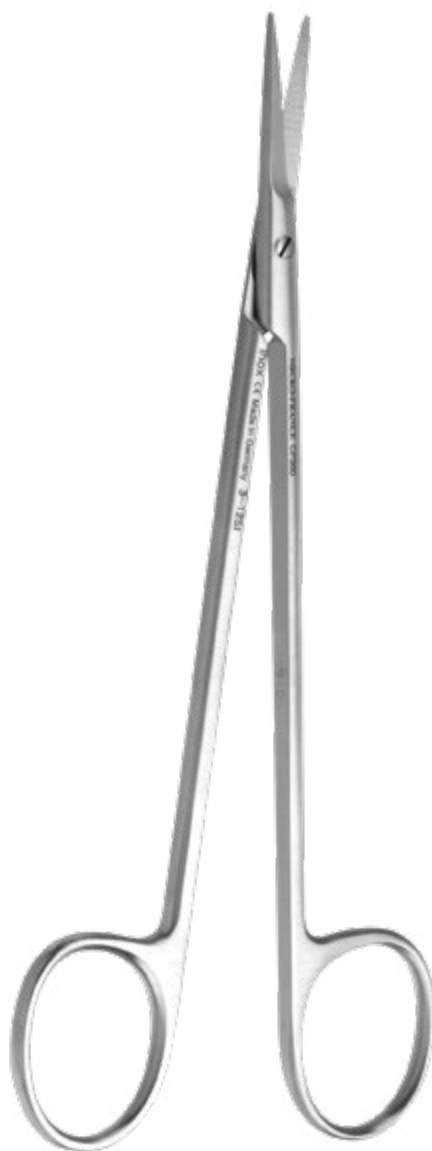

150mm  
**CP360**  
Droits



120mm  
**713T**  
Coudés  
lames tungstène  
coupe-fil d'acier

**Beebe**



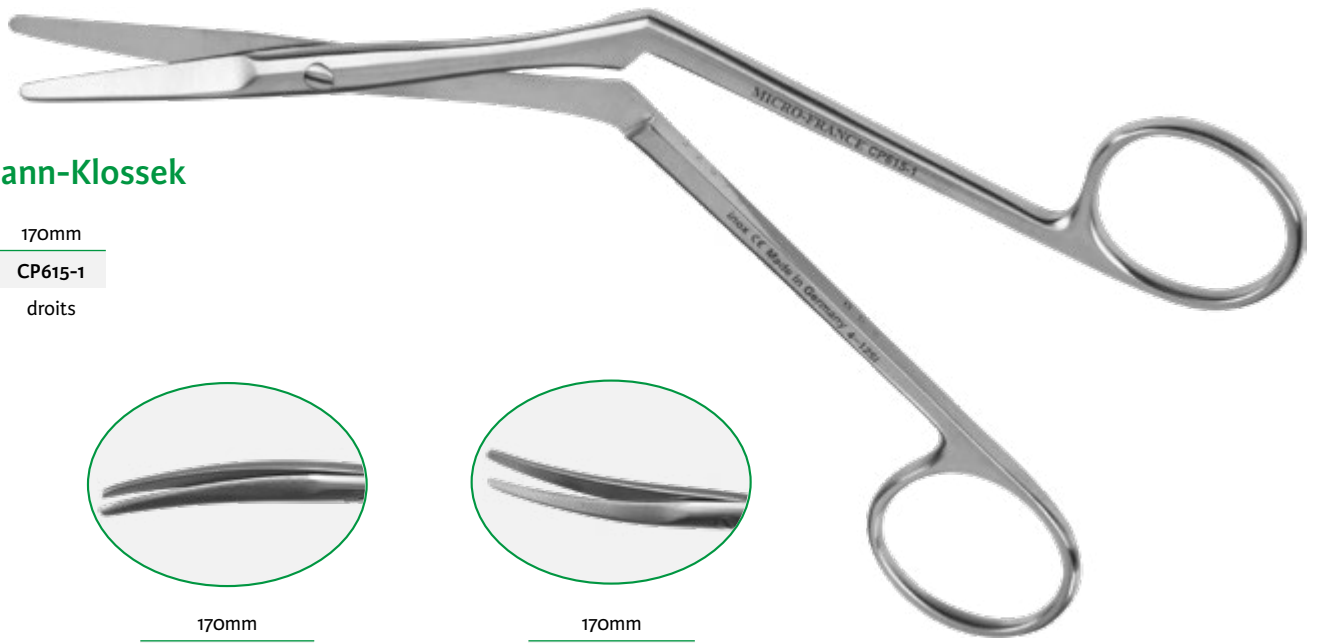

## Heymann-Klossek

170mm  
CP615-1  
droits

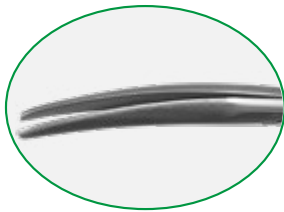

170mm  
CP615-2  
Courbes à gauche

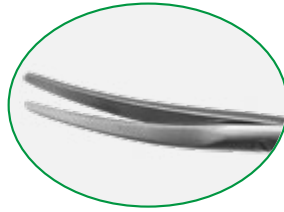

170mm  
CP615-3  
Courbes à droite

Pince à disséquer 110mm



**Castroviejo**

CP938-1

Griffes horizontales et plateaux lisses

**Castroviejo**

CP37

Griffes obliques et plateaux lisses

CP332

Mors striés croisés 1,4mm

Pince à disséquer 120mm

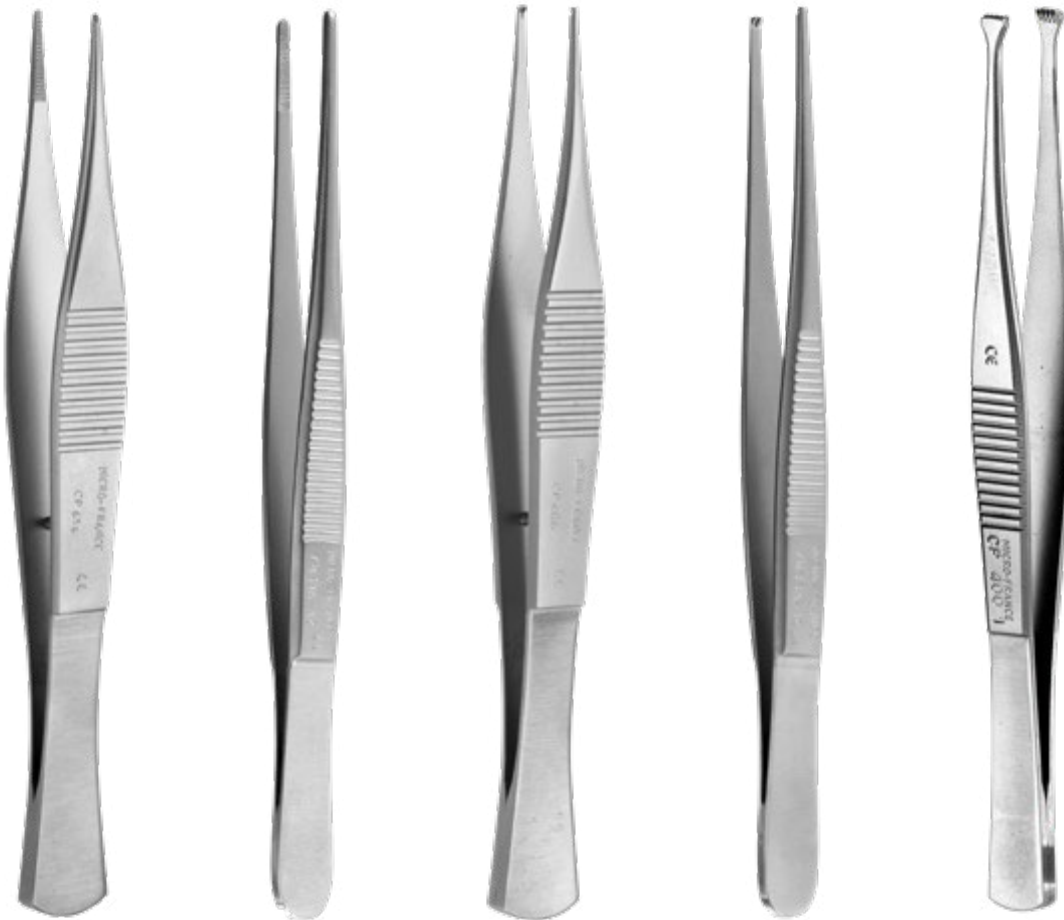

mors striés

CP414

Mors 1mm

7831A-12

Mors 1,5mm

CP406

Mors 1mm

mors à griffes

7833A-12

Mors 1,5mm

CP400-1

5x5 griffes

**150mm**

**Adson**



- CP604-15 mors striés 1,5mm
- CP605-15 mors à griffes 1,5mm

**Adson-Brown**



- CP606-15 mors 7x7 griffes

**120mm**



Adson-Tubiana

Adson

Adson-Brown

Mors 1mm

Mors 1,5mm

Mors 1,5mm

Mors 7x7 griffes

<b>M832</b>	<b>M833</b>	<b>CP604</b>	<b>CP605</b>	<b>CP606A</b>	<b>CP606</b>
striés	à griffes	striés	à griffes	striés tungstène	

120mm



**Adson-Tubiana**

M801

mors 1x2 griffes et plateaux lisses



**Mac-Indoe**

140mm



CP934

Griffes obliques et plateaux striés



CP934-1

Plateaux striés

**Debakey**

**Barraya**

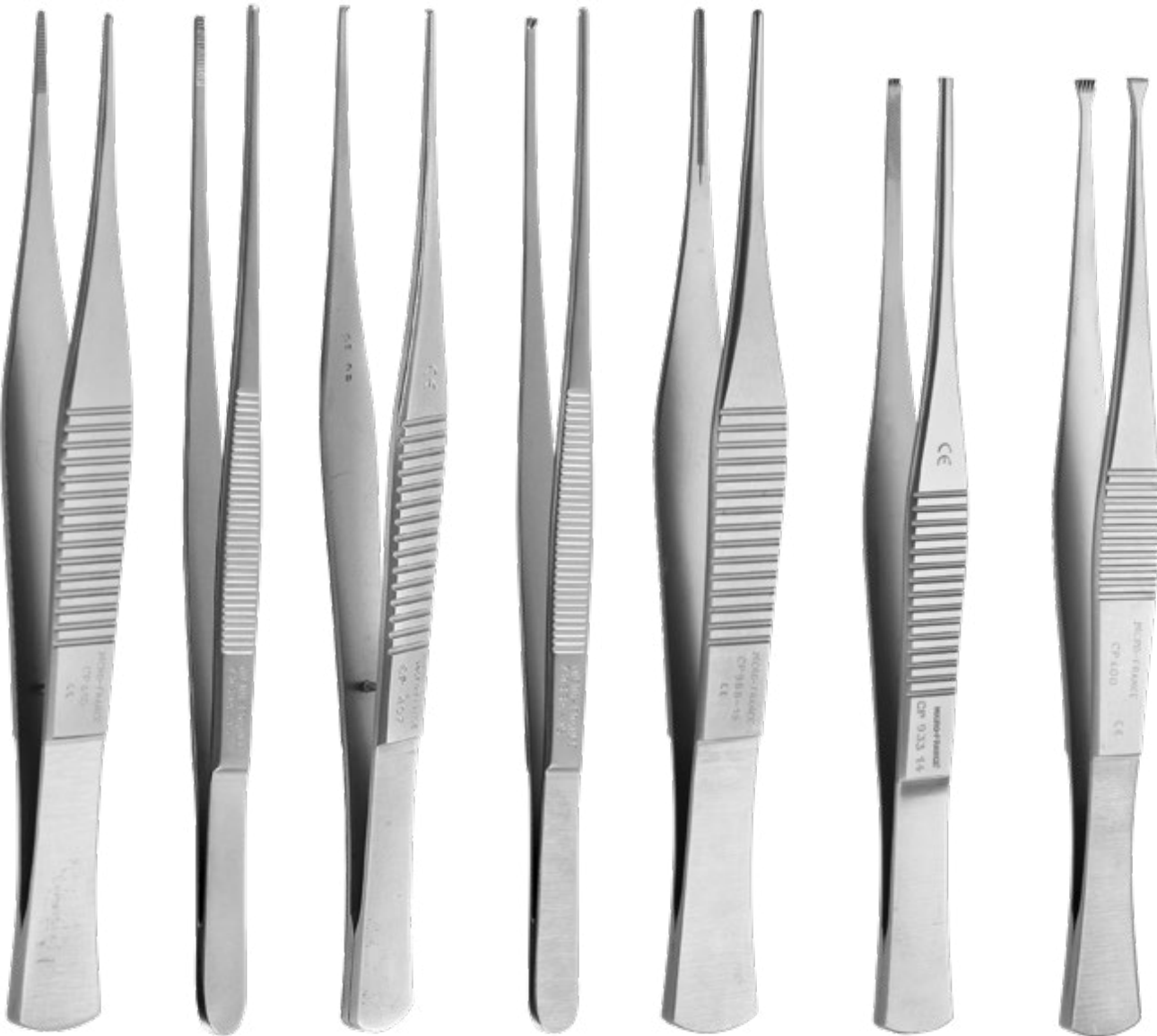

150mm

140mm

CP415	7831A-15	CP407	7833A-15	CP988-15	CP933-14	CP400
Mors striés 1mm	Mors striés 1,5mm	Mors à griffes 1mm	Mors à griffes 1,5mm	Mors 1,5mm	3x4 griffes et plateaux striés	Mors 5x5 griffes

Précelle



150mm

CP345

striée

Barraya



160mm

CP933-16

3x4 griffes  
et plateaux striés

Claoué



160mm

CP401

5x6 griffes

Mac-Indoe



170mm

CP936

1x2 griffes  
et plateaux striés

Debaquey

Barraya



1,5mm  
7831A-18



1,5mm  
CP988-18



1mm  
CP409  
1x2



1,5mm  
7833A-18  
1x2



1,5mm  
CP933-18  
3x4  
et plateaux striés



6x6  
CP400-2

Debaquey



200mm	210mm
7832	7834
1mm mors striés	1mm 1x2 griffes



2mm
7831A-20



1,5mm
CP988-20



2mm
7833A-20
1x2

Câbles bipolaires - 4,5 m



CP393-2

Bowa Emc Lamidey Valleylab



CP393-3

Erbe VIO ICC ACC (sauf international) Storz Wolf



CP393-4

Aesculap Berchtold Martin Sutter BM-780 II

Magnan

Adson

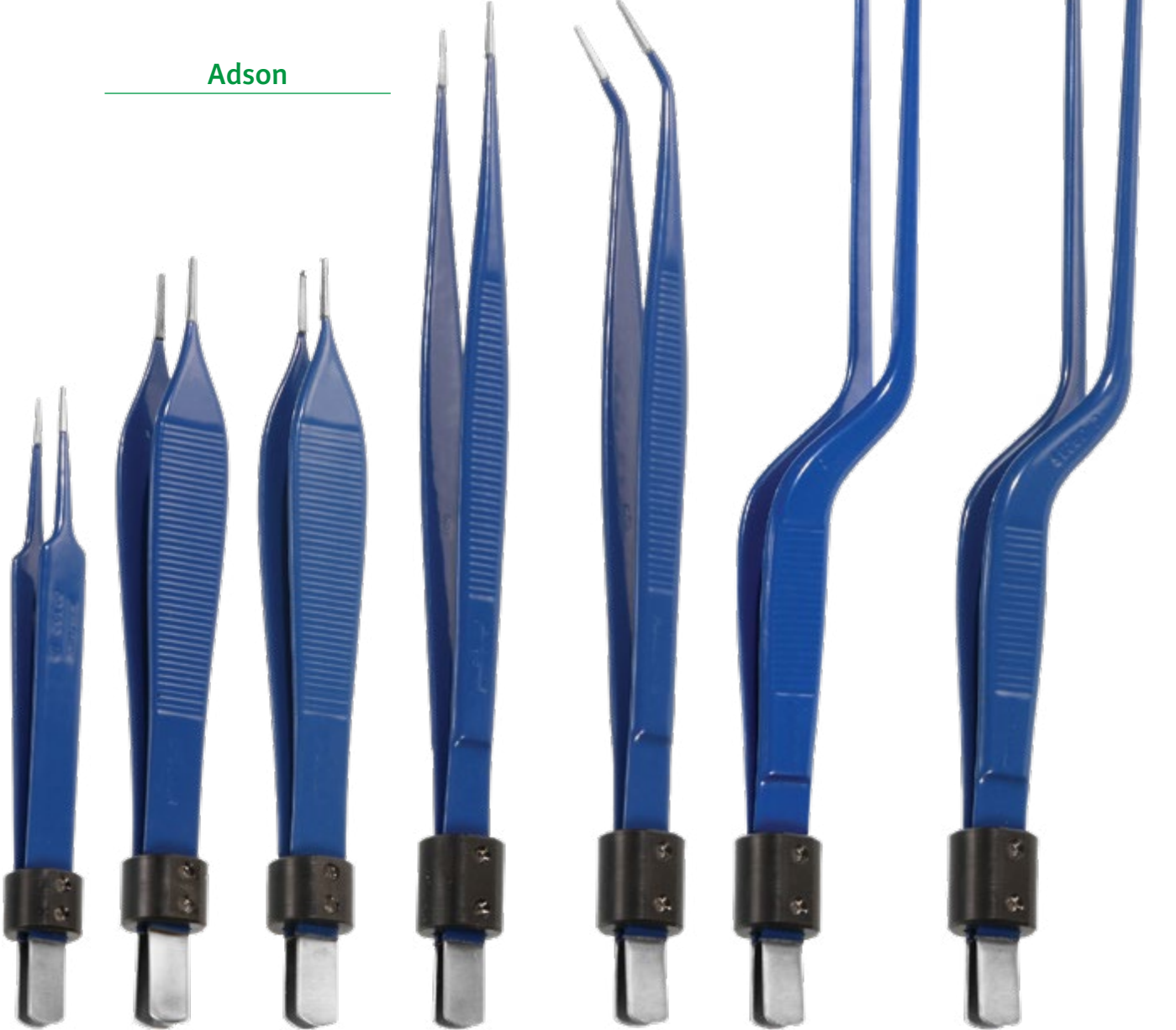

110mm

120mm

160mm

200mm

CP392-1R

CP604BR

CP605BR

CP392-2R

CP392-8R

CP392BI

CP392BS

Mors lisses  
1x8mm

Mors striés  
1,5mm

Mors à griffes  
1,5mm

Mors lisses  
1x8mm

Mors lisses  
1x8mm

Mors lisses  
0,5x5mm

Mors lisses  
0,5x5mm



Câbles bipolaires - 4,5 m



**CP393-2**  
Bowa Emc Lamidey Valleylab



**CP393-3**  
Erbe VIO ICC ACC  
(sauf international)  
Storz Wolf



**CP393-4**  
Aesculap Berchtold Martin  
Sutter BM-78o II

CP392-3R	CP392-10R	CP392-5R	CP392-9R
Droite	Coudée	Baïonnette	Baïonnette
Mors lisses	Mors lisses	Mors lisses	Mors coudés
1x8mm	1x8mm	1x8mm	1x8mm





Adson



110mm

CP390-1

Mors lisses  
1x8mm



120mm

CP604M

Mors striés  
1,5mm



CP605M

Mors à griffes  
1,5mm



160mm

CP390-2

Mors lisses  
1x8mm



CP390-8

Mors à griffes  
1x8mm

Echelle 2/3

Longueur utile - «L»

**Chambon**



290mm L 260mm

**CP390L26**

Mors lisses 1x8mm



**CP390-3**

Mors lisses 1x8mm



230mm L 200mm

**CP390-5**

Mors coudés 1x8mm



**CP390-7**

Mors lisses 1x8mm

Câbles monopolaires 3,5 m



**CP391E**

Erbe ACC ICC/VIO  
Storz Wolf



**CP391M**

Aesculap Berchtold Martin  
Erbe T Serie Lamidey  
Sutter BM-780 II



**CP391V**

Bowa Bovie Conmed Valleylab





Halsey

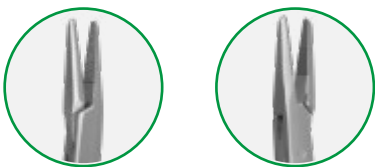

130mm

703T

704T

Mors striés

Mors lisses



Crile-Wood Mayo-Hégar

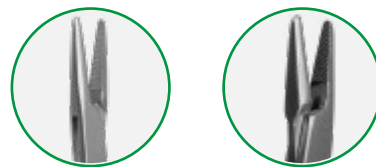

150mm

702T

714T



**Becker**

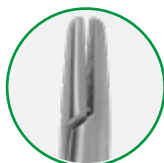

130mm

CP1107

Mors diamantés

Crile-Wood

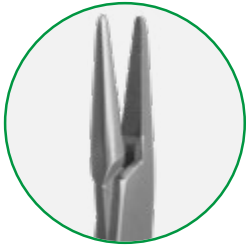

200mm

720T



Crile-Wood

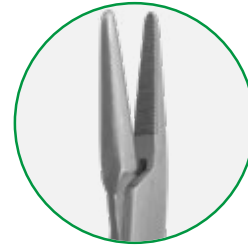

180mm

701T



Stratte



210mm

7945T

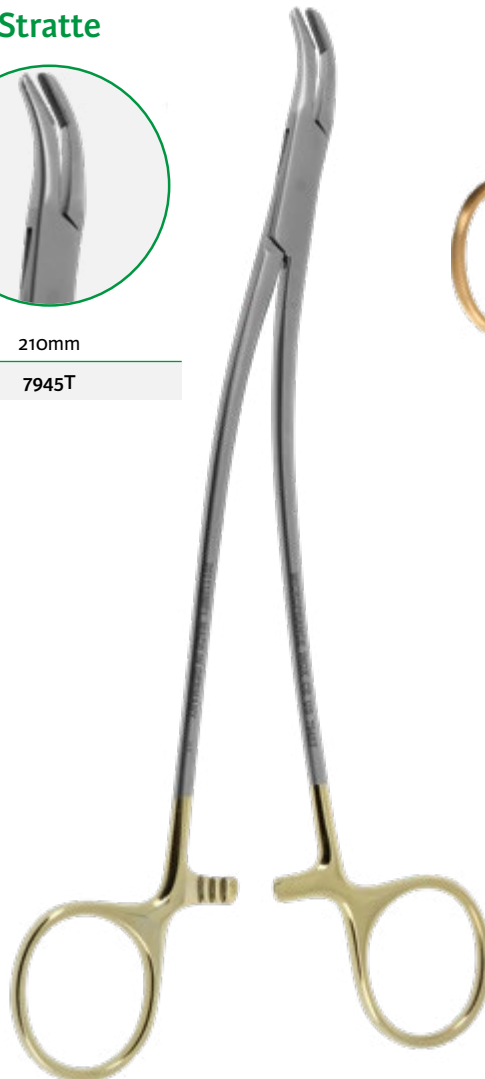

### Leriche

140mm - sans griffe

7867-1	7867-2
--------	--------

Droite	Courbe
--------	--------

140mm - à griffes

7867-3	7867-4
--------	--------

Droite	Courbe
--------	--------



7867-1

### Halsted

120mm - à griffes

P761-7	P761-8
--------	--------

Droite	Courbe
--------	--------



P761-7

### Kelly

Sans griffe

140mm	160mm
-------	-------

P762-2	P762-4
--------	--------

Courbe	Courbe
--------	--------



P762-2

### Kocher

140mm	160mm	180mm
-------	-------	-------

Droite sans griffe

P764-1	P764-5	-
--------	--------	---

Droite à griffes

P764-3	P764-7	P764-11
--------	--------	---------



P764-3

### Martel

130mm

P763

Pince striée  
à griffes en «T»



### Péan

140mm 160mm

P765-14 P765-16

Pince hémostatique  
striée



P765-14

### Terrier

130mm

P769

Pince hémostatique  
mors striés



### Chaput

130mm

7866-13

2x3 griffes



Pince hémostatique  
fenêtrée  
160mm

P770

mors en cœur

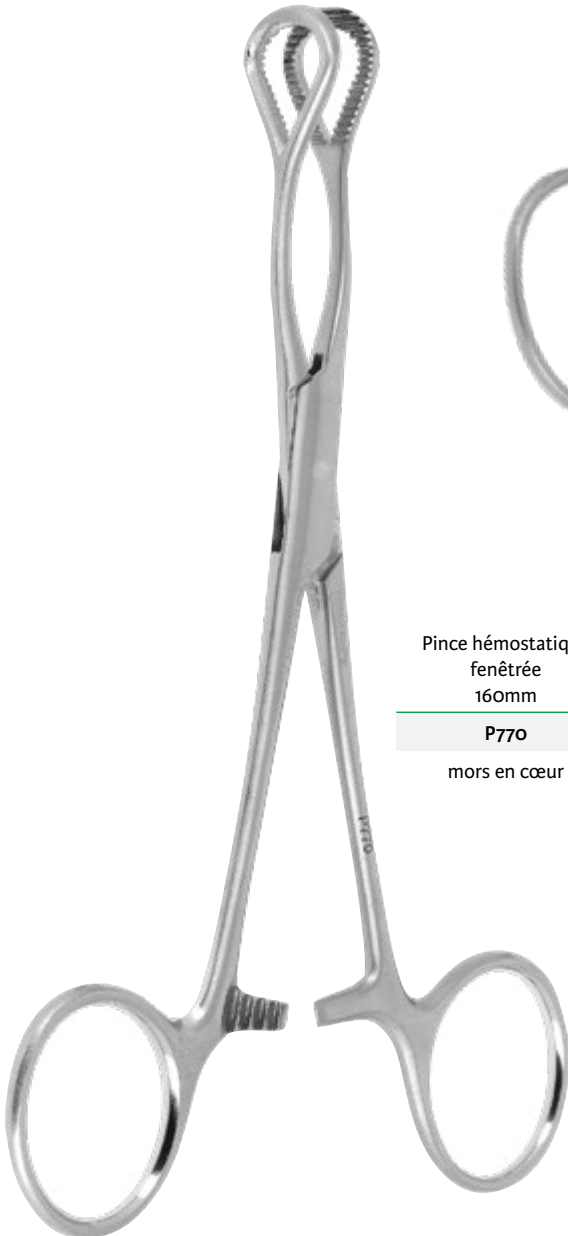

### Ombredanne

Pince à griffes  
130mm

P771



Râpes



CP85L

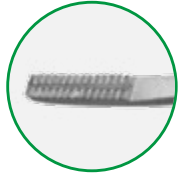

**Stenstrom**

160mm - 2x8mm

CP85L

CP85R

Courbe à gauche

Courbe à droite

CP85R



Décolleurs



CP85AL

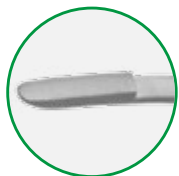

**Stenstrom**

160mm - 2x8mm

CP85AL

CP85AR

Courbe à gauche

Courbe à droite

CP85AR





Longueur utile «L»

Micro canule à irrigation



MCM10-0-5 Ø 0,5mm L 30mm  
MCM10-1-0 Ø 1,0mm

Micro clamp vasculaire - L 13mm

**Gilbert O'Brien**

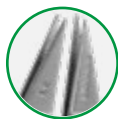

Moyen

MCM13

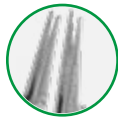

Petit

MCM13-1

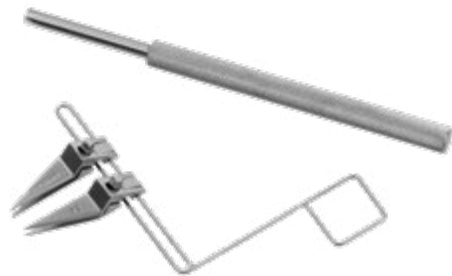

MCM13

Micro pince à disséquer - 150mm



MCM4BISR

Mors à griffes et plateaux

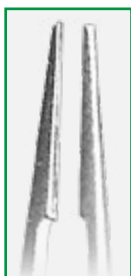

MCM4R

Mors lisses à plateaux



MCM4BISR

Pince de joaillier



130mm

MCM973D3 n°3

MCM973D5 n°5

Micro ciseaux

**Vanas**

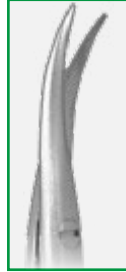

**MCM7BISR**

8mm  
Courbes mousses

**Vanas**



**MCM7R**

8mm  
Droits crantés



**MCM970**

8mm  
Courbes atraumatiques



**MCM7BISR**  
150mm

Micro porte-aiguille

**O'Brien**



**MCM12R**

5x0.3mm  
Mors lisses courbes

**Barraquer-Comtet**



**MCM1R**

8mm  
Mors lisses droits



**MCM12R**  
150mm

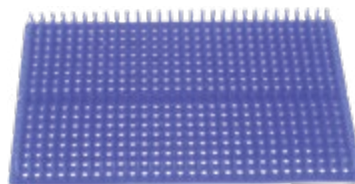

**MCM25-3**

210x130mm

Echelle 1/4

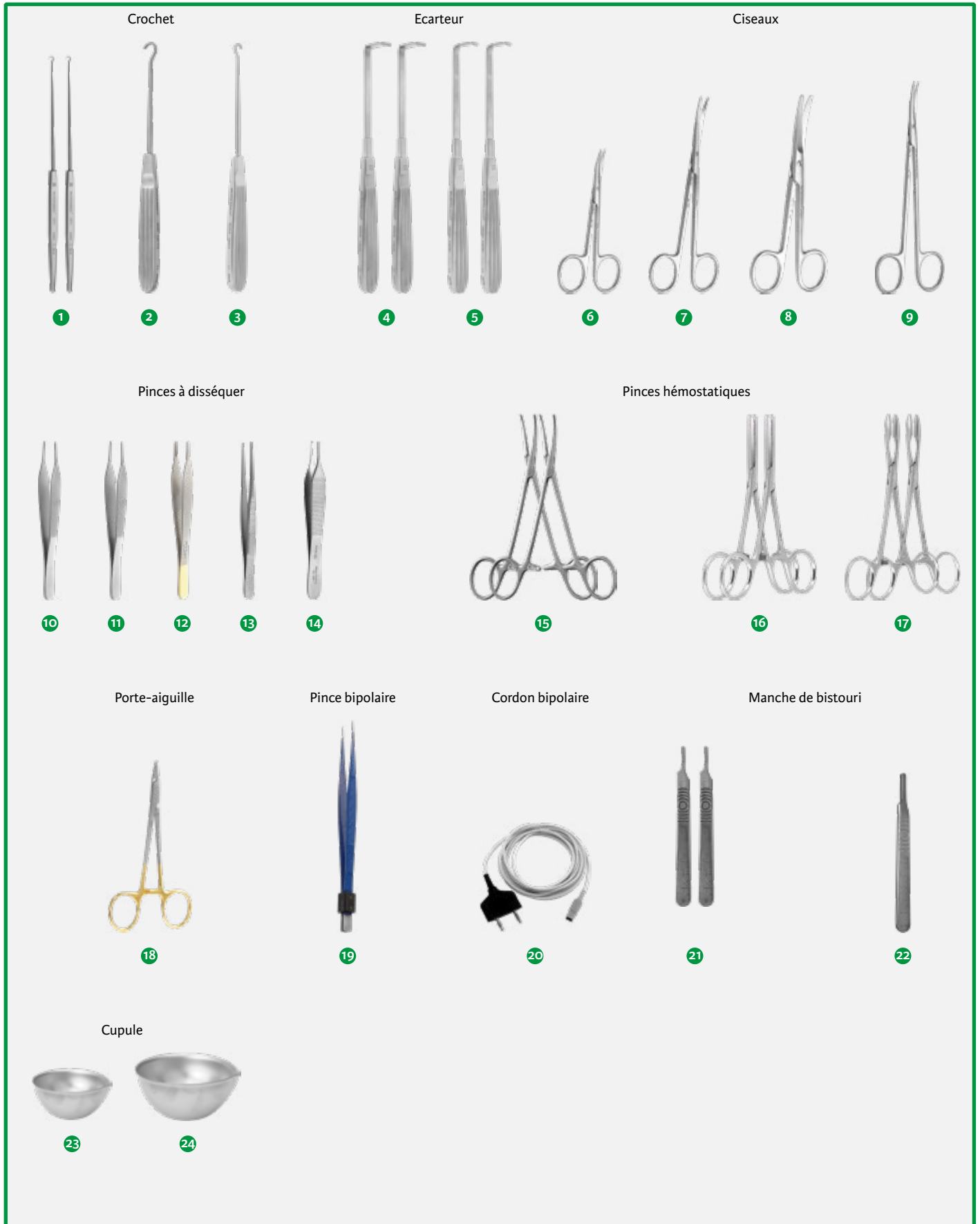

### Composition du set de la main de Gilbert

N°	Reference	Description	Qt	Détail
1	CP17	Crochet pointu 3mm 180mm de Gillies	2	page 13
2	M809	Crochet mousse à tendons grande taille 190mm	1	
3	M809A	Crochet mousse à tendons petite taille 190mm	1	
4	M806A	Ecarteur mousse 10X20mm 190mm de Tubiana-Gilbert	2	
5	M806E	Ecarteur mousse 5X20mm 190mm de Tubiana-Gilbert	2	
6	CP922A	Ciseaux courbes lames mousses fines 110mm de Stevens	1	page 38
7	CP931-1	Ciseaux courbes lames mousses fines 150mm de Metzenbaum	1	page 40
8	CP352-1	Ciseaux courbes lames plates 150mm de Mayo	1	page 41
9	CP921	Ciseaux courbes lames mousses 160mm de Reynolds	1	page 39
10	M801	Pince à disséquer 1x2 griffes et plateaux lisses 120mm de Adson-Tubiana	1	
11	M833	Pince à disséquer 1x2 griffes 120mm mors 1mm de Adson-Tubiana	1	
12	CP606A	Pince à disséquer striée 120mm mors tungstènes 1.5mm de Adson	1	page 47
13	7833A-12	Pince à disséquer 1x2 griffes 120mm mors 1.5mm	1	page 46
14	CP605	Pince à disséquer 1x2 griffes 120mm mors 1.5mm de Adson	1	page 47
15	7867-2	Pince hémostatique courbe sans griffe 140mm de Leriche	2	page 60
16	P764-3	Pince hémostatique droite à griffes 140mm de Kocher	2	page 61
17	P765-14	Pince hémostatique striée 140mm de Péan	2	page 62
18	703T	Porte-aiguille mors tungstènes aiguilles 4/0 5/0 130mm de Halsey	1	page 57
19	CP392-2R	Pince à disséquer bipolaire droite mors 1x8mm 160mm	1	page 53
20	CP393-2	Câble électrique bipolaire 2 fiches bananes pour Bowa Emc Lamidey Valleylab 4,5 mètres <sup>(1)</sup>	1	page 53
21	1003IG <sup>(D)</sup>	Manche de bistouri pour lames 11/15 120mm n°3 avec graduations de 0 à 55mm	2	page 09
22	1004IG <sup>(D)</sup>	Manche de bistouri pour lames 23 120mm n°4 avec graduations de 0 à 55mm	1	page 09
23	7876-60 <sup>(D)</sup>	Cupule inox à bec verseur Ø60mm 60ml	1	page 82
24	7876-80 <sup>(D)</sup>	Cupule inox à bec verseur Ø80mm 100ml	1	page 82

<sup>(1)</sup> Contacter le service client pour un câble électrique bipolaire compatible avec un générateur différent de ceux mentionnés

Echelle 1/2



M809

Crochet à tendons 190mm

M809	M809A
grand	petit

### Tubiana-Gilbert



M806A

Ecarteur mousse 190mm

M806A	M806E
10x20mm	5x20mm



M801

### Adson-Tubiana

Pince à disséquer 120mm

M801	M833
1x2 griffes et plateaux lisses	1x2 griffes mors 1mm

<sup>(D)</sup> Distribué par Integra MicroFrance SAS (France) - Voir tableau d'équivalence annexe pour la référence du fabricant correspondante

Echelle 1/2

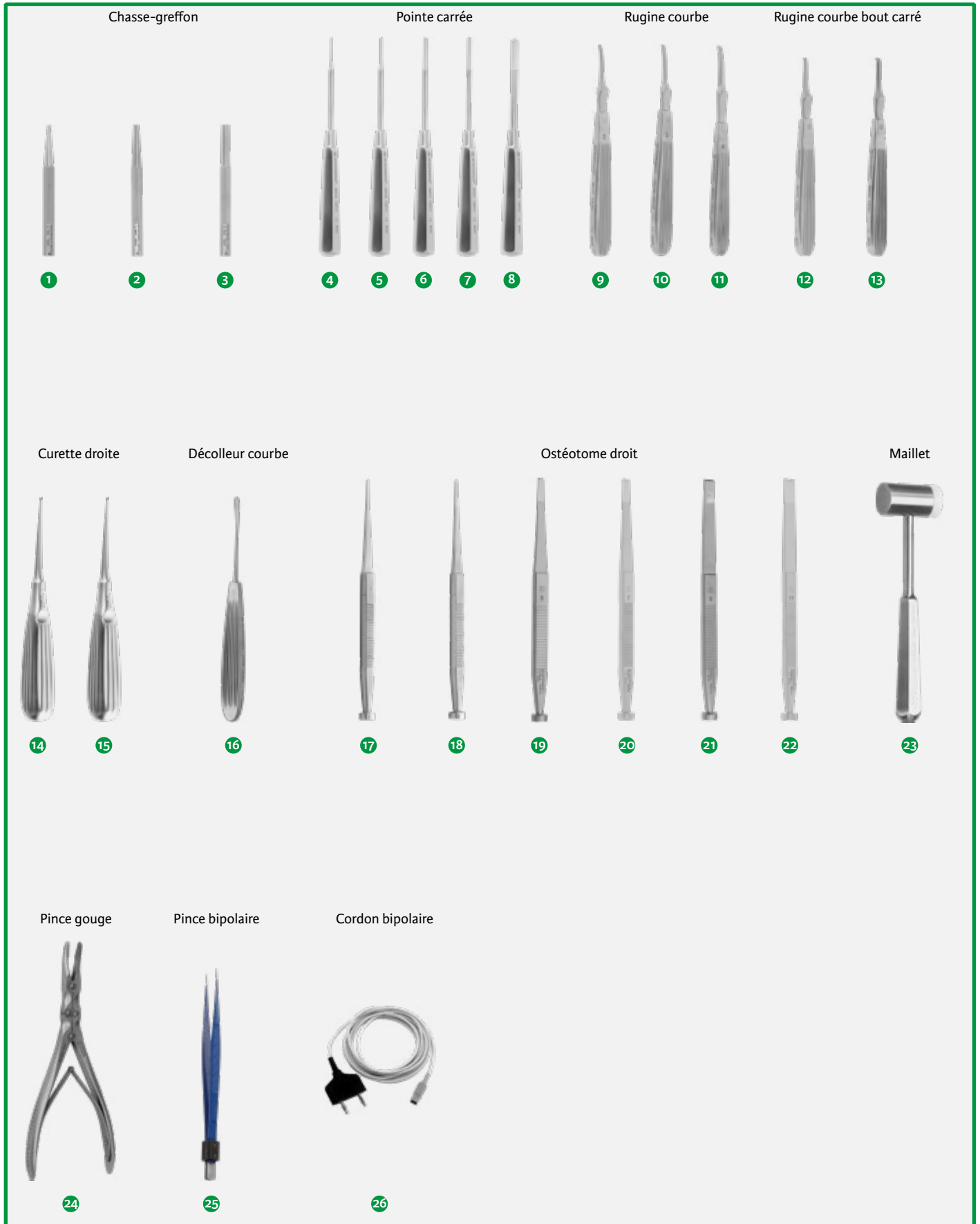

### Composition du set OS de Gilbert

N°	Reference	Description	Qt	Page
1	M821A	Chasse-greffon Ø2mm 100mm	1	
2	M821B	Chasse-greffon Ø4mm 100mm	1	
3	M821C	Chasse-greffon Ø6mm 100mm	1	
4	M823A	Pointe carrée 1mm 165mm	1	
5	M823B	Pointe carrée 2mm 165mm	1	
6	M823C	Pointe carrée 3mm 165mm	1	
7	M823D	Pointe carrée 4mm 165mm	1	
8	M823E	Pointe carrée 5mm 165mm	1	
9	M813C	Rugine courbe 2mm 160mm	1	
10	M813B	Rugine courbe 3mm 160mm	1	
11	M813A	Rugine courbe 4mm 160mm	1	
12	M815B	Rugine courbe bout carré 3mm 150mm	1	
13	M815A	Rugine courbe bout carré 4mm 150mm	1	
14	CP302-2	Curette droite 2mm 170mm de <b>Volkman</b>	1	page 26
15	CP302-3	Curette droite 3mm n°0000 170mm de <b>Volkman</b>	1	page 26
16	CP958	Décolleur courbe 5mm 170mm de <b>Trélat</b>	1	page 74
17	CP304-2	Ostéotome droit 2mm 185mm de <b>Marchac</b>	1	page 22
18	CP304-3	Ostéotome droit 3mm 185mm de <b>Marchac</b>	1	page 22
19	CP304-5	Ostéotome droit 5mm 185mm de <b>Marchac</b>	1	page 22
20	CP304-7	Ostéotome droit 7mm 185mm de <b>Marchac</b>	1	page 22
21	CP304-9	Ostéotome droit 9mm 185mm de <b>Marchac</b>	1	page 22
22	CP304-11	Ostéotome droit 11mm 185mm de <b>Marchac</b>	1	page 22
23	CP907	Maillet rond 1 face téflon 200Gr 180mm	1	page 19
24	CP380-3	Pince gouge double articulation mors courbes 2mm 180mm de <b>Beyer</b>	1	page 32
25	CP392-2R	Pince à disséquer bipolaire droite mors 1x8mm 160mm	1	page 53
26	CP393-2	Câble électrique bipolaire 2 fiches bananes pour <b>Bowa Emc Lamidey Valleylab</b> 4,5 mètres <sup>(1)</sup>	1	page 53

<sup>(1)</sup> Contacter le service client pour un câble électrique bipolaire compatible avec un générateur différent de ceux mentionnés

Echelle 1/2



M815A

Rugine courbe bout carré 160mm

M815A	M815B
4mm	3mm



M813B

Rugine courbe 150mm

M813A	M813B	M813C
4mm	3mm	2mm



M823C

Pointe carrée 165mm

M823A	M823B	M823C	M823D	M823E
1mm	2mm	3mm	4mm	5mm



M821B

Chasse-greffon 100mm

M821A	M821B	M821C
Ø2mm	Ø4mm	Ø6mm

Echelle 1/2

**Masson**

7809MF

140mm



**Doyen**

7821B

120mm

7821A

140mm



7821B

7805-11



**Seemann-Seiffert**

7805-11

110mm

7805-13

130mm

**Jennings**

7804-9

90mm

7804-11

110mm

7804-13

130mm

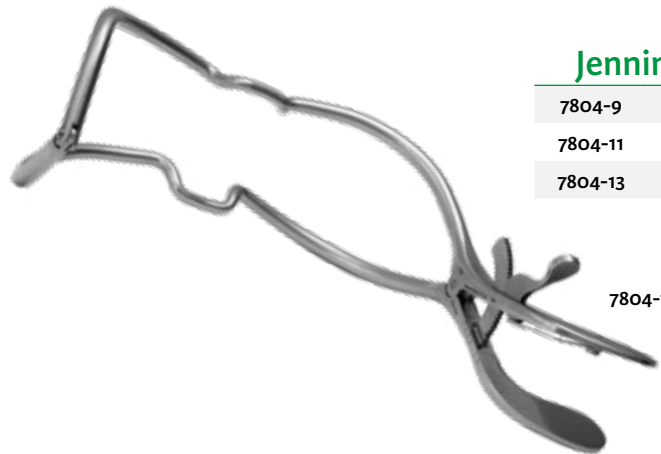

7804-13

Malléable



8mm      10mm      12mm      15mm      20mm

CP818-8      CP818-10      CP818-12      CP818-15      CP818-20

**Dautrey**

**Dautrey**



15x40mm

15x55mm



15x60mm

15x85mm

Malléable



10mm

15mm

Ecarteur à lambeaux  
10/15mm - 160mm

7773

210mm

CP818-8

140mm

CP984

140mm

CP984-1



### Ginestet

260mm

**CP986**

Crochet pointu



### Lindemann

Fraise forèt à fissure



**164RS-1-8<sup>(D)</sup>** 45mm tige 33mm

**168RS<sup>(D)</sup>** 70mm tige 45mm

<sup>(D)</sup> Distribué par Integra MicroFrance SAS (France) - Voir tableau d'équivalence annexe pour la référence du fabricant correspondante

### Tessier

130mm

**CP501B**

Ecarteur à condyle  
6x60mm

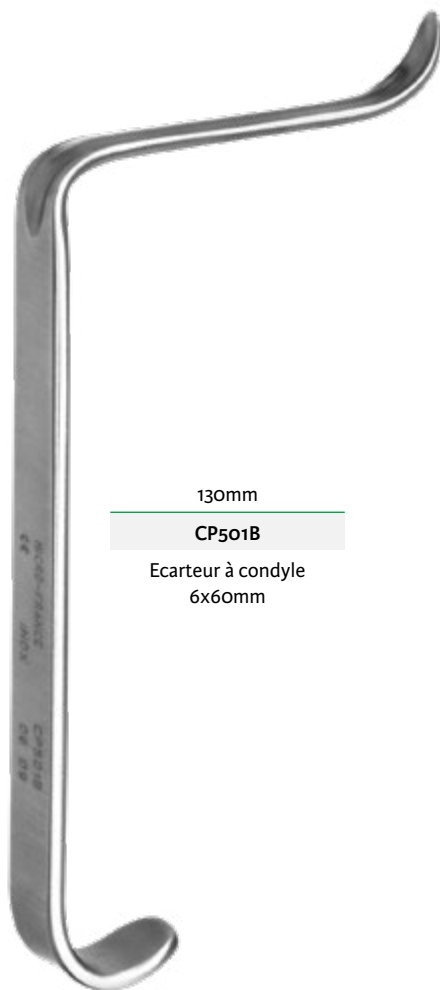

180mm

**CP521**

Pince à expansion



**Obwegeser**

145mm

CP522

Passe-fil courbe  
aiguille mandibulaire



**Kawamoto**

**Veau**

**Trélat**



Ostéotome courbe  
175mm

Bistouri crochet 90° pointu  
165mm

Décolleur courbe  
170mm

Rugine courbe  
170mm

CP324

CP956

CP957

CP958

CP959

CP960

10mm

8mm

6mm

5mm

3mm

4mm

Tessier



120mm

CP364

Courbes



160mm

CP914

Courbes



160mm  
CP357-1  
Courbes



200mm  
CP357-2  
Courbes

## Trepsat



200mm

CP369-2



CP369-1

Droits spatulés

5,5mm



CP369-2

Droits spatulés

8,5mm



CP369-3

Droits spatulés

13mm

Pinces à griffes à lifting

Assumpção

Pitanguy

Servant

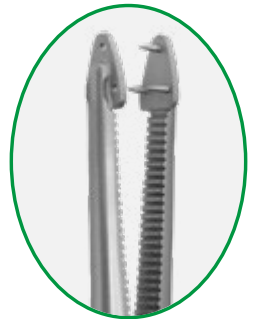
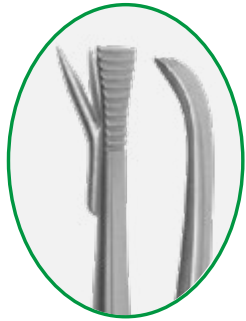

180mm  
CP829T  
à crémaillère

160mm  
CP830

150mm  
CP994  
Pince à désépidermiser

Ecarteurs à lifting

Freeman

Ecarteur mousse à lifting



190mm

Freeman

Ecarteur pointu peigne à lifting



180mm



CP819-12	CP819-15	CP826	CP826-1
85x12mm	85x15mm	35mm	20mm

Echelle 1/3

Longueur utile «L»

## Décolleur coudé spatulé



**Slamia**

320mm - L 200mm

CP845

## Marqueur anneau rond à seins

Marqueur anneau rond à seins - Ø 38/42mm

Echelle 1/1

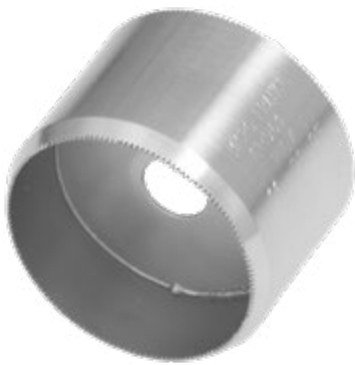

CP961

Double cranté



CP961-1

Double tranchant

Marqueur anneau rond à seins



CP980-45

### Dufourmentel

CP980-35	Ø 35mm
CP980-40	Ø 40mm
CP980-45	Ø 45mm
CP980-50	Ø 50mm
CP980-55	Ø 55mm



Décolleur à seins Echelle 1/3

Agris-Dingmann

370mm - L 250mm



A Gauche

CP991L

A Droite

CP991R

Tenseur Mammaire

Mole

290mm



CP981

Photos à titre indicatif, sans échelle



Cupule

7876-60 <sup>(D)</sup>	60mm
7876-80 <sup>(D)</sup>	80mm
7876-100 <sup>(D)</sup>	100mm
7876-120 <sup>(D)</sup>	120mm
7876-160 <sup>(D)</sup>	160mm



Plateau inox

7872-24 <sup>(D)</sup>	240x180mm
------------------------	-----------



MCO731<sup>(D)</sup>

Spray lubrifiant instruments

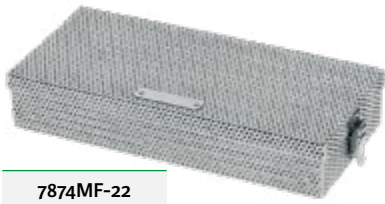

7874MF-22

220x100x40mm

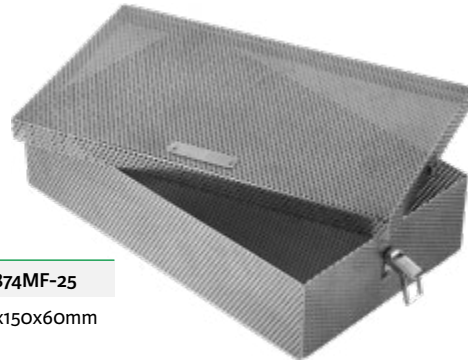

7874MF-25

250x150x60mm

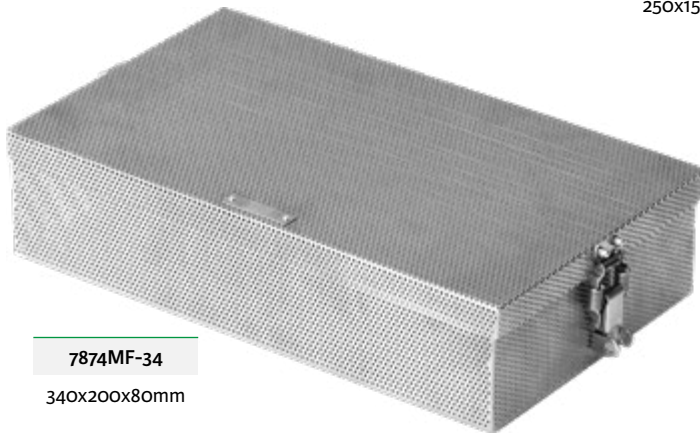

7874MF-34

340x200x80mm

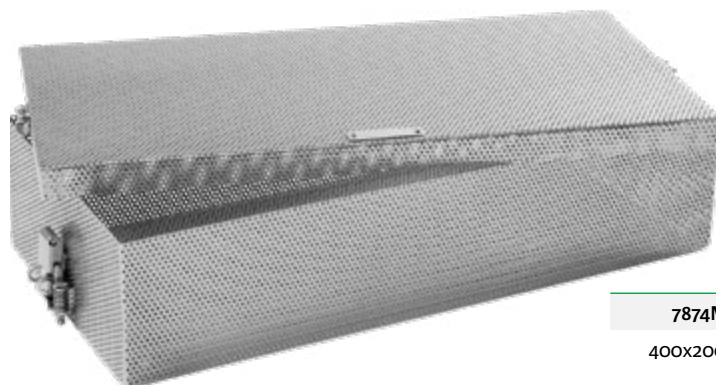

7874MF-40

400x200x90mm

<sup>(D)</sup> Distribué par Integra MicroFrance SAS (France) - Voir tableau d'équivalence annexe pour la référence du fabricant correspondante

## **Index numérique**

**1**

164RS-1-8(D) .....	73
168RS(D) .....	73
1003IG(D) .....	9, 68
1003LI(D) .....	9
1004IG(D) .....	9, 68
1005I(D) .....	9

**3**

3714024 .....	14
3714025 .....	14
3714026 .....	14
3714027 .....	15
3714028 .....	15
3714055 .....	21
3714056 .....	21
3714057 .....	21
3714058 .....	21
3714096 .....	26
3714098 .....	23
3714099 .....	23
3714107 .....	14
3714108 .....	14
3714109 .....	14
3714111 .....	14
3714148 .....	30
3714149 .....	30
3714164 .....	10
3714166 .....	10
3714182 .....	17
3714183 .....	17
3714187 .....	17
3714320 .....	21
3714364 .....	14
3714678 .....	10
3724059 .....	11
3724256 .....	14

**7**

701T .....	59
702T .....	57
703T .....	57, 68
704T .....	57
713T .....	44
714T .....	57
720T .....	59
7726MF .....	3
7727 .....	3
7728 .....	3

7732-1 .....	3
7733 .....	3
7734 .....	3
7765 .....	35
7766 .....	19
7768 .....	13
7768-1 .....	13
7773 .....	72
7779MF-1 .....	4
7779MF-2 .....	4
7779MF-3 .....	4
7779MF-5CC .....	4
7782-1-2 .....	15
7783-12 .....	4
7787-10 .....	11
7804-9 .....	71
7804-11 .....	71
7804-13 .....	71
7805-11 .....	71
7805-13 .....	71
7809MF .....	71
7821A .....	71
7821B .....	71
7831A-12 .....	46
7831A-15 .....	49
7831A-18 .....	51
7831A-20 .....	52
7832 .....	52
7833A-12 .....	46, 68
7833A-15 .....	49
7833A-18 .....	51
7833A-20 .....	52
7834 .....	52
7866-13 .....	63
7867-1 .....	60
7867-2 .....	60, 68
7867-3 .....	60
7867-4 .....	60
7872-24(D) .....	82
7874MF-22 .....	82
7874MF-25 .....	82
7874MF-34 .....	82
7874MF-40 .....	82
7876-60(D) .....	68, 82
7876-80(D) .....	68, 82
7876-100(D) .....	82
7876-120(D) .....	82
7876-160(D) .....	82
7903-50-5(D) .....	4
7945T .....	59

**A**

AQ1728(D) .....	31
-----------------	----

**CP**

CP16 .....	36
CP16-1 .....	36
CP17 .....	13, 68
CP17-1 .....	13
CP17-2 .....	13
CP17-3 .....	13
CP21-3 .....	15
CP21A-3 .....	15
CP23-4 .....	17
CP23-6 .....	17
CP23-8 .....	17
CP23-10 .....	17
CP23A-8 .....	17
CP37 .....	46
CP85AL .....	64
CP85AR .....	64
CP85L .....	64
CP85R .....	64
CP291 .....	28
CP300 .....	19
CP301 .....	27
CP301-1 .....	27
CP301-2 .....	28
CP301-3 .....	28
CP301-4 .....	29
CP301-5 .....	29
CP301-9 .....	29
CP301-10 .....	29
CP302-2 .....	26, 70
CP302-3 .....	26, 70
CP302-4 .....	26
CP302-5 .....	26
CP302-6 .....	26
CP302-8 .....	26
CP304-2 .....	22, 70
CP304-3 .....	22, 70
CP304-4 .....	22
CP304-5 .....	22, 70
CP304-6 .....	22
CP304-7 .....	22, 70
CP304-8 .....	22
CP304-9 .....	22, 70
CP304-10 .....	22
CP304-11 .....	22, 70
CP304-12 .....	22
CP304-14 .....	22

<sup>(D)</sup> Distribué par Integra MicroFrance SAS (France) - Voir tableau d'équivalence annexe pour la référence du fabricant correspondante

CP304-15 .....	22	CP344DT .....	12	CP391M .....	55, 56
CP304-16 .....	22	CP344E .....	12	CP391V .....	55, 56
CP304B-2 .....	22	CP344ET .....	12	CP392-1R .....	53
CP304B-3 .....	22	CP345 .....	50	CP392-2R .....	53, 68, 70
CP304B-4 .....	22	CP348 .....	42	CP392-3R .....	54
CP304B-5 .....	22	CP350 .....	44	CP392-5R .....	54
CP304B-6 .....	22	CP351-1 .....	40	CP392-8R .....	53
CP304B-8 .....	22	CP351-2 .....	40	CP392-9R .....	54
CP304B-10 .....	22	CP351-3 .....	40	CP392-10R .....	54
CP304B-12 .....	22	CP351-5 .....	40	CP392BI .....	53
CP305 .....	23	CP351-6 .....	40	CP392BS .....	53
CP305L .....	23	CP351-7 .....	40	CP393-2 .....	53, 54, 68, 70
CP305R .....	23	CP352 .....	41	CP393-3 .....	53, 54
CP306 .....	17	CP352-1 .....	41, 68	CP393-4 .....	53, 54
CP309-8-12 .....	24	CP352-2 .....	41	CP400 .....	49
CP309-10-14 .....	24	CP352-3 .....	41	CP400-1 .....	46
CP309-12-16 .....	24	CP353 .....	36	CP400-2 .....	51
CP309-14-16 .....	24	CP354 .....	36	CP401 .....	50
CP309-14-18 .....	24	CP354A .....	36	CP406 .....	46
CP310 .....	12	CP355 .....	37	CP407 .....	49
CP310D .....	12	CP355A .....	37	CP409 .....	51
CP310E .....	12	CP355C .....	39	CP414 .....	46
CP313 .....	25	CP356 .....	36	CP415 .....	49
CP313-1 .....	25	CP357-1 .....	76	CP501B .....	73
CP314-14 .....	24	CP357-2 .....	76	CP521 .....	73
CP315 .....	23	CP358 .....	36	CP522 .....	74
CP315D .....	23	CP358A .....	36	CP604 .....	47
CP315G .....	23	CP359 .....	43	CP604-15 .....	47
CP316 .....	23	CP360 .....	44	CP604BR .....	53
CP317 .....	22	CP362 .....	37	CP604M .....	55
CP318 .....	22	CP363 .....	38	CP605 .....	47, 68
CP324 .....	74	CP364 .....	75	CP605-15 .....	47
CP330-3-0 .....	8	CP365 .....	39	CP605BR .....	53
CP330-4-0 .....	8	CP367 .....	37	CP605M .....	55
CP331 .....	16	CP367-1 .....	37	CP606 .....	47
CP331-1 .....	16	CP369-1 .....	77	CP606-15 .....	47
CP332 .....	46	CP369-2 .....	77	CP606A .....	47, 68
CP333 .....	10	CP369-3 .....	77	CP609 .....	15
CP335 .....	15	CP380 .....	32	CP611 .....	5
CP337 .....	7	CP380-1 .....	32	CP612 .....	42
CP337-1 .....	7	CP380-2 .....	32	CP613 .....	42
CP338 .....	16	CP380-3 .....	32, 70	CP614 .....	43
CP339 .....	16	CP380-5 .....	32	CP615-1 .....	45
CP340 .....	16	CP381 .....	34	CP615-2 .....	45
CP341 .....	16	CP390-1 .....	55	CP615-3 .....	45
CP344A .....	12	CP390-2 .....	55	CP616-13 .....	39
CP344AT .....	12	CP390-3 .....	56	CP616-15 .....	39
CP344B .....	12	CP390-5 .....	56	CP621 .....	33
CP344BT .....	12	CP390-7 .....	56	CP622-4 .....	10
CP344C .....	12	CP390-8 .....	55	CP624-45 .....	2
CP344CT .....	12	CP390L26 .....	56	CP624-55 .....	2
CP344D .....	12	CP391E .....	55, 56	CP624-65 .....	2

<sup>(D)</sup> Distribué par Integra MicroFrance SAS (France) - Voir tableau d'équivalence annexe pour la référence du fabricant correspondante

CP624-75.....	2
CP624LF-75.....	2
CP625.....	5
CP626.....	6
CP627.....	6
CP628.....	13
CP630.....	18
CP632.....	18
CP635.....	42
CP637.....	38
CP640.....	31
CP801-7.....	20
CP801-10.....	20
CP802.....	23
CP803.....	16
CP806.....	25
CP807.....	25
CP808-6.....	25
CP809.....	28
CP810.....	27
CP814-1.....	31
CP814-2.....	31
CP814-3.....	31
CP818-8.....	72
CP818-10.....	72
CP818-12.....	72
CP818-15.....	72
CP818-20.....	72
CP819-12.....	79
CP819-15.....	79
CP821.....	9
CP822-10.....	13
CP822-12.....	13
CP822-14.....	13
CP823-5.....	21
CP824-5.....	21
CP825.....	11
CP826.....	79
CP826-1.....	79
CP828.....	27
CP829T.....	78
CP830.....	78
CP845.....	80
CP905.....	27
CP907.....	19, 70
CP914.....	75
CP919.....	36
CP919A.....	36
CP921.....	39, 68
CP922.....	38
CP922A.....	38, 68

CP922B.....	38
CP931.....	40
CP931-1.....	40, 68
CP931-3.....	40
CP931-5.....	40
CP933-14.....	49
CP933-16.....	50
CP933-18.....	51
CP934.....	49
CP934-1.....	49
CP936.....	50
CP938-1.....	46
CP941.....	13
CP947.....	18
CP949-45.....	2
CP949-55.....	2
CP949-75.....	2
CP956.....	74
CP957.....	74
CP958.....	70, 74
CP959.....	74
CP960.....	74
CP961.....	80
CP961-1.....	80
CP973.....	28
CP974.....	28
CP976.....	28
CP978.....	27
CP980-35.....	80
CP980-40.....	80
CP980-45.....	80
CP980-50.....	80
CP980-55.....	80
CP981.....	81
CP984.....	72
CP984-1.....	72
CP985.....	5
CP986.....	73
CP988-15.....	49
CP988-18.....	51
CP988-20.....	52
CP991L.....	81
CP991R.....	81
CP994.....	78
CP997.....	37
CP998-1.....	28
CP1100.....	28
CP1102.....	7
CP1103.....	7
CP1104.....	29
CP1105.....	29

CP1106.....	42
CP1107.....	58
CP1109.....	31

## M

M801.....	48, 68
M806A.....	68
M806E.....	68
M809.....	68
M809A.....	68
M812A.....	13
M813A.....	70
M813B.....	70
M813C.....	70
M815A.....	70
M815B.....	70
M821A.....	70
M821B.....	70
M821C.....	70
M823A.....	70
M823B.....	70
M823C.....	70
M823D.....	70
M823E.....	70
M832.....	47
M833.....	47, 68

## MCEN

MCEN2.....	2
MCEN770J30.....	8
MCEN770J40.....	8

## MCL

MCL38N(D).....	2
MCL75.....	2
MCL170(D)(1).....	2
MCL171(D)(1).....	2
MCL173(D)(1).....	2
MCL174(D)(1).....	2
MCL197(D)(1).....	2

## MCM

MCM1R.....	66
MCM4BISR.....	65
MCM4R.....	65
MCM7BISR.....	66
MCM7R.....	66

MCM10-0-5.....	65
MCM10-1-0.....	65
MCM12R.....	66
MCM13.....	65
MCM13-1.....	65
MCM25-3.....	66
MCM970.....	66
MCM973D3.....	65
MCM973D5.....	65

P770.....	63
P771.....	63

---

**S**

---

SCP337A.....	7
--------------	---

---

**MCO**

---

MCO201-2-5.....	8
MCO201-3-0.....	8
MCO214-13-10.....	20
MCO214-13-20.....	20
MCO214-13-40.....	20
MCO214-13-60.....	20
MCO214-13-80.....	20
MCO305.....	5
MCO731(D).....	82
MCO770-1-5.....	8
MCO770-2-0.....	8
MCO770-2-5.....	8
MCO770-3-0.....	8
MCO770-3-5.....	8
MCO770-4-0.....	8
MCO771-2-5.....	8
MCO771-3-0.....	8
MCO771-4-0.....	8
MCO803.....	5
MCO979.....	11
MCO988.....	11
MCO995.....	19

---

**P**

---

P761-7.....	60
P761-8.....	60
P762-2.....	61
P762-4.....	61
P763.....	62
P764-1.....	61
P764-3.....	61, 68
P764-5.....	61
P764-7.....	61
P764-11.....	61
P765-14.....	62, 68
P765-16.....	62
P769.....	62

<sup>(1)</sup> Produit non dispositif médical

<sup>(2)</sup> Distribué par Integra MicroFrance SAS (France) - Voir tableau d'équivalence annexe pour la référence du fabricant correspondante





**Tableau d'équivalence  
à titre informatif**

Integra MicroFrance® référence produit	Référence fabricant équivalente
1003IG	M3IG
1003LI	M3LI
1004IG	M4IG
1005I	M5I
164RS-1-8	39164RF104018
168RS	39168RF105023
7872-24	1224
7876-100	310
7876-120	312
7876-160	316
7876-60	306
7876-80	308
7903-50-5	13.202
AQ1728	PS-1728
MCL170 <sup>(1)</sup>	CO101
MCL171 <sup>(1)</sup>	CO201
MCL173 <sup>(1)</sup>	CO100
MCL174 <sup>(1)</sup>	CO200
MCL197 <sup>(1)</sup>	CO103
MCL38N	EC-BLU50U090
MCM9	201/A
MCO731	430490

<sup>(1)</sup> Produit non dispositif médical



## Fabricants :



Integra MicroFrance SAS (France)  
Le Pavillon ■ 03160 Saint Aubin le Monial ■ France



Hager & Meisinger GmbH  
Hansenmannstrasse 10  
D- 41468 Neuss ■ Allemagne



Swann Morton Ltd  
Penn Works ■ Owlerton Green ■ Sheffield  
South Yorkshire S6 2BJ ■ Royaume Uni



Unimed SA  
Rue du Grand-Pré 10  
1007 Lausanne ■ Suisse

## Fabricants avec produits du catalogue uniquement de classe I



Agencinox  
Zone Industrielle  
89110 Aillant sur Tholon ■ France



Chemische Fabrik Dr. Weigert GmbH & Co.  
Mühlenhagen  
D-20539 Hamburg ■ Allemagne



Moria S.A.  
15, rue Georges Besse  
92160 Antony ■ France



Qfix  
440 Church Road  
Avondale ■ PA 19311 USA



Medical devis & QA Services Ltd  
76, Stockport Road ■ Timperley  
Cheshire ■ WA15 75N ■ Royaume Uni



Sunoptic Technologies  
6018 Bowdendale Avenue  
Jacksonville 32216 ■ Florida USA



RMS - UK Limited  
28 Trinity Road ■ Nailsea  
Somerset BS48 4NU ■ Royaume Uni

## Informations supplémentaires pour les clients Europe, Moyen-Orient, Afrique :

**Attention :** la loi restreint la vente de ces appareils à des médecins ou suite à leur prescription.

Toutes les références mentionnées dans ce document sont marquées CE en accord avec la directive du conseil Européen 93/42/EEC sur les dispositifs médicaux et ses amendements, sauf ceux spécifiquement identifiés comme "NON MARQUÉ CE".

Les produits mentionnés dans ce document ne sont pas inscrits à la Liste des Produits et Prestations Remboursables (LPPR) mentionnée à l'article L165-1 du code de la sécurité sociale et ne sont pas éligibles au remboursement par l'Assurance Maladie.

Tous les textes et diagrammes contenus dans ce catalogue sont à considérer comme des notes d'orientations et sont à but illustratif seulement. Aucune information contenue dans ce catalogue n'a pour but de se substituer au mode d'emploi présent dans chaque emballage des produits Integra. Veuillez toujours vous référer au mode d'emploi approprié pour les instructions cliniques complètes. Pour des informations supplémentaires techniques et cliniques sur les produits Integra, veuillez contacter votre spécialiste Integra. Lire attentivement la notice d'instructions du produit.

La disponibilité de ces produits peut varier d'un pays ou d'une région à l'autre du fait de procédures d'enregistrement réglementaires ou de conditions de vente locales spécifiques.

Les produits identifiés par le symbole <sup>(®)</sup> sont distribués par Integra MicroFrance SAS (France).

Produits de classe I, Im, IIa, IIb. Pour plus d'informations sur la classe des produits, veuillez contacter le Service Client Integra.

Date de dernière révision: 12/2020

## Pour plus d'informations, veuillez contacter le service client :

### Europe, Moyen-Orient, Afrique

International : +33 (0) 437 47 59 50 ■ +33 (0) 437 47 59 25 (Fax) ■ [csemea@integralife.com](mailto:csemea@integralife.com)  
France : +33 (0) 437 47 59 10 ■ +33 (0) 437 47 59 29 (Fax) ■ [custservfrance@integralife.com](mailto:custservfrance@integralife.com)  
Royaume-Uni : +44 (0) 1264 312 725 ■ +44 (0) 1264 312 821 (Fax) ■ [custsvcs.uk@integralife.com](mailto:custsvcs.uk@integralife.com)  
Belgique & Luxembourg : +32 (0)2 257 4130 ■ +32 (0)2 253 2466 (Fax) ■ [custsvcbenelux@integralife.com](mailto:custsvcbenelux@integralife.com)  
Pays-Bas : +31(0) 852 083 167 ■ +31(0) 207 093 627 (Fax) ■ [custsvcnetherlands@integralife.com](mailto:custsvcnetherlands@integralife.com)  
Italie : +39 (0)2 577 8921 ■ +39 (0)2 575 113 71 (Fax) ■ [custsvcitaly@integralife.com](mailto:custsvcitaly@integralife.com)  
[integralife.eu/contact](http://integralife.eu/contact)

MicroFrance, Integra et le logo Integra sont des marques enregistrées de Integra LifeSciences Corporation ou de ses filiales aux USA et/ou dans d'autres pays. Toutes les autres marques et noms de produits sont la propriété de leurs propriétaires respectifs.

©2020 Integra LifeSciences Corporation. Tous droits réservés.

0328574-6-FR

DOCUMENT DESTINE A L'EUROPE, AU MOYEN-ORIENT ET A L'AFRIQUE UNIQUEMENT.