

Integra[®] MicroFrance[®]

Catalogue Integra ORL - Nez

Table des matières	ii	Râpes diverses	37
Service Client et Garanties	vi	Attelle, Plaque moule	38
Indications / Contre-indications	vii	Presse-greffe, Perforateur à os	39
Consultation	2-3	Rongeur	40
Aspirateur sonde	2	Pince gouge double articulation	41
Canule pour examen	2	Pince coudée	42
Galvano-cautère	2	Pince coupante à os	43
Micro crochet	3	Pince septum	44
Poire	2	Ciseaux pointus courts, finition mat	45
Porte-coton	3	Ciseaux pointus courts	46
Sonde stylet	3	Ciseaux pointus longs	47
Spéculum à ressort	2	Ciseaux mousses courts, finition mat	48
Spéculum à vis	2	Ciseaux mousses courts	49
Spéculum à manche	4	Ciseaux mousses courbes longs	50
Spéculum à manche autostatique - Lumière froide	5	Ciseaux Metzenbaum petits, finition mat	51
Bras articulé	6	Ciseaux de Mayo, finition mat	52
Pince à disséquer coudée	7	Ciseaux angulés	53
Pince coudée	8	Ciseaux crantés	54
Seringue	9	Pince à disséquer fine	55
Décolleur - Rugine	10-11	Pince à disséquer Adson	56
Décolleur aspirateur	12-13	Pince à disséquer moyenne	57-58
Scalpel	14	Pince à disséquer 180mm	59-60
Bistouri	15	Pince à disséquer 200mm	61
Rugine courbe	16-17	Pince à disséquer bipolaire moyenne	62
Ecarteur	18-23	Pince à disséquer monopolaire moyenne	63
Curette	24-25	Porte-aiguille mors tungstène	64
Maillet	26-27	Pince hémostatique fine	65
Ciseau burin - Ciseau gouge	28	Pince hémostatique moyenne	66
Ostéotome	29	Pince hémostatique striée, Pince à griffes en "T"	67
Ostéotome boutonné	30	Pince à griffes fortes	68
Ostéotome boutonné des 2 côtés	31	Aspirateur à soupape	69
Ostéotome fin	32	Micro aspirateur / raccord	70
Ostéotomes divers	33		
Râpe droite	34		
Râpe courbe	35		
Râpe double 210 mm	36		

Aspirateur boutoné	71-72	Instruments Lemoine , Klossek, Kennedy	97
Système aspiration irrigation de Frazier	73	Chignole à manivelle	97
Accessoires de rhinolaveur de Dessi	74	Fraise forêt à butée variable	97
Chemise pour optique	74	Instruments Vaughan	98
Tubulure irrigation stérile	74	Instruments Parsons	99
Drain - Trocart	75	Instruments Duncavage	100
Luxateur décolleur	76	Instrumentation orbitale Levine	101
Micro palpateur - Pointe	77	Instrumentation frontale Wormald	102
Bistouri décolleur	78	Instrumentation base du crâne Wormald	103-104
Micro bistouri et décolleur	78	Instrumentation base du crâne Stamm	105
Micro bistouri tige contre coudée	78	Panier, Cupule, Lubrifiant	106
Micro décolleur coudé	78	Index numérique	107
Micro pince mors curettes	79	Tableau d'équivalence à titre informatif	113
Micro pince mors curettes de De Gabory	80		
Micro pince mors curettes de Jankowski	81		
Micro pince mors curettes de Rouvier	82		
Micro pince mors curettes de Weil-Blakesley	83		
Micro pince mors curettes pédiatrique	84		
Micro pince courbe fine mors curettes	85		
Micro pince courbe en bas	86		
Micro pince punch rétrograde	87		
Micro pince punch rétrograde pédiatrique	88		
Micro pince punch	89		
Micro pince punch fine	90		
Micro pince rongeur	91		
Micro ciseaux	92		
Micro pince applicateur de clips	93		
Micro pince bipolaire	94		
Micro pince bipolaire aspirante	95		
Micro instrument monopolaire	96		
Aspirateur à soupape	96		
Bistouri lancéolé	96		
Crochet	96		
Décolleur aspirateur	96		
Pointes	96		

Garantie limitée d'Integra

Pour connaître les garanties applicables, merci de vous référer aux garanties précisées dans l'emballage de chaque produit.

Contacts Services Clients :

International

+33 (0) 4 37 47 59 50
+33 (0) 4 37 47 59 25 (fax)
csemea@integralife.com

France

+33 (0) 4 37 47 59 10
+33 (0) 4 37 47 59 29 (Fax)
custservfrance@integralife.com

Belgique & Luxembourg

+32 (0) 2 257 4130
+32 (0) 2 253 2466 (Fax)
custsvcbenlux@integralife.com

Royaume-Uni

+44 (0) 1264 312 725
+44 (0) 1264 312 821 (Fax)
custsvcs.uk@integralife.com

Pays-Bas

+31 (0) 852 083 167
+31 (0) 207 093 627 (Fax)
custsvcnetherlands@integralife.com

Italie

+39 (0) 2 577 8921
+39 (0) 2 575 113 71 (Fax)
custsvitaly@integralife.com

Instrumentation O.R.L. MicroFrance®

INDICATIONS

- Tous les dispositifs médicaux présentés dans ce catalogue sont indiqués pour les consultations ORL et/ou la chirurgie ORL.
- Les dimensions présentes dans ce document ne sont pas contractuelles et sont données à titre indicatif seulement.

CONTRE-INDICATIONS

- Ne pas utiliser dans d'autres indications que celles prévues (mentionnées) dans la notice d'instructions ou l'étiquetage.

Explications sur la présentation de ce catalogue

Titre et/ou famille produit

Consultation **INTEGRA**
LIMIT UNCERTAINTY

Marquet Legent

Représentation de l'instrument à l'échelle 1/1 sauf indications contraires

Tableau explicatif voir ci-dessous

Vue détaillée de l'instrument

Micro crochets mousses 90°		Micro crochet mousse 45°	Porte-coton bout torsillé 15mm	Sonde stylet caudal à plaque préformée caudique 150mm
MCO805	MCO806A	MCO807	7719-2	7731
160mm	160mm	160mm	140mm	110mm
2mm	2,5mm	1mm	Ø 1,2mm	longueur utile 80mm

DOCUMENT DESTINE A L'EUROPE, AU MOYEN-ORIENT ET A L'AFRIQUE. 3

Explications sur le tableau référence produit et description complémentaire

Titre ou sous titre	
description complémentaire globale	
Réf. produit1	description complémentaire1
Réf. produit2	description complémentaire2

Galvano-cautère



Aspirateur sonde



Spéculum à ressort, à vis

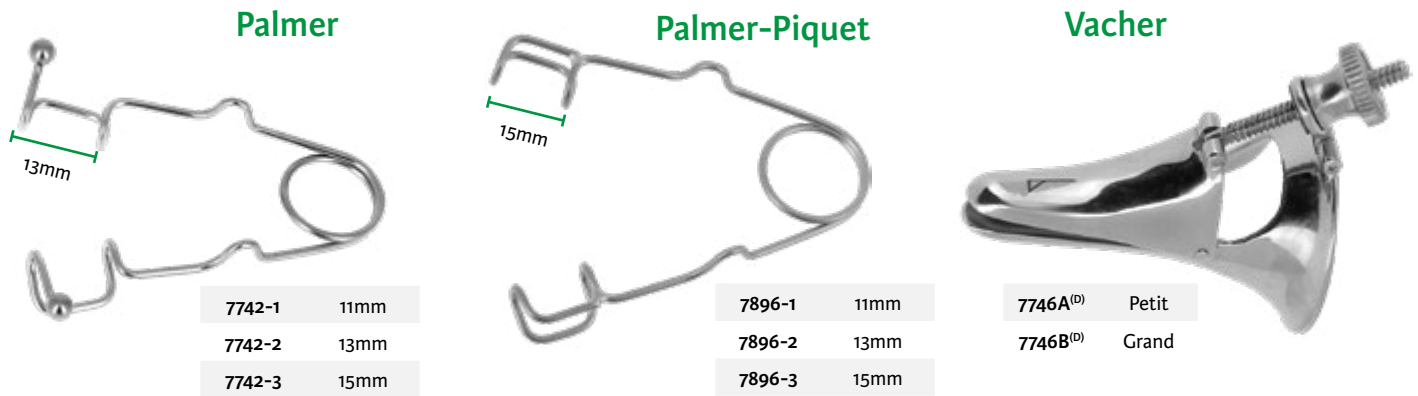

Canule pour examen



Poire



^(D) Distribué par Integra MicroFrance SAS (France) - Voir tableau d'équivalence annexe pour la référence du fabricant correspondante

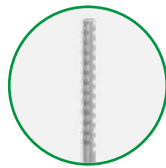
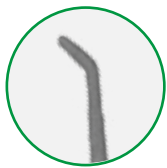
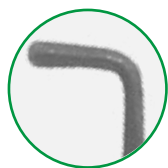

Marquet

Legent



Micro crochets mousses
90°

Micro crochet mousse
45°

Porte-coton bout tortillé
15mm

Sonde stylet coudé
à plaque porte-caustique

165mm

165mm

140mm

110mm

MCO805

MCO805A

MCO950

MCO807

7719-2

7731

2mm

2,5mm

0,8mm

1mm

Ø 1,2mm

longueur utile 80mm

Hartmann



160mm
7898

Tieck-Halle



130mm
7897

Beckman



140mm
7899
Main gauche

Viennois

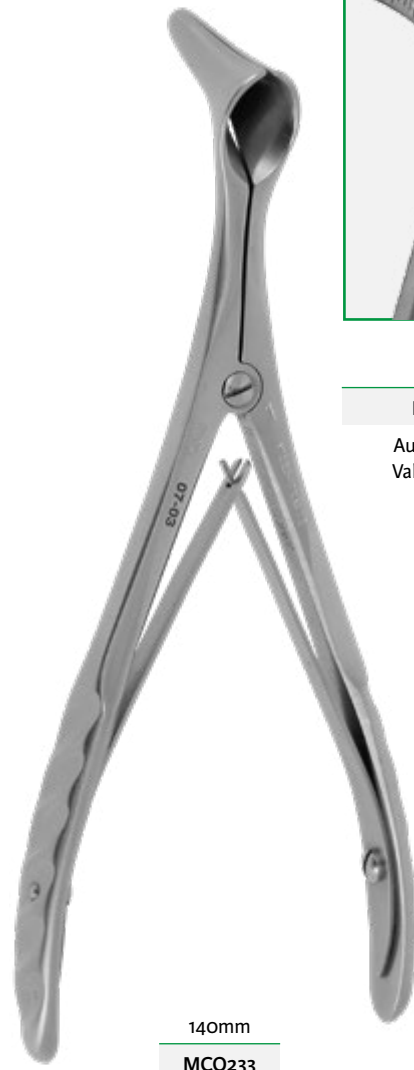

140mm
MCO233
Dilatateur



140mm
MCO237
Autostatique
Valves striées

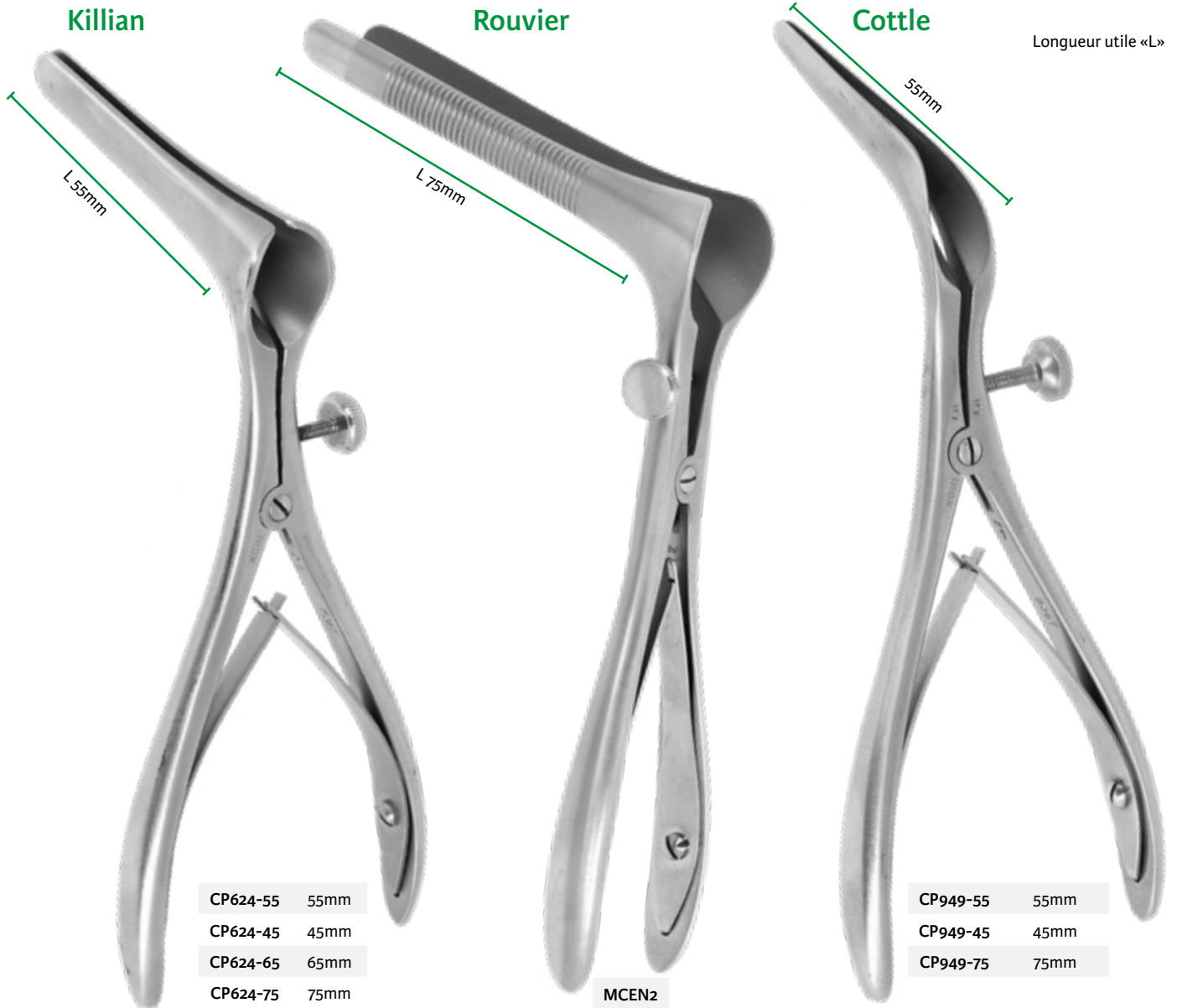

Spéculum à lumière froide - Câble à lumière froide 220cm - Raccords



⁽¹⁾ Produit non dispositif médical

^(D) Distribué par Integra MicroFrance SAS (France) - Voir tableau d'équivalence annexe pour la référence du fabricant correspondante

Bras articulé

Legend



Bras articulé complet

MCO980

livré avec MCO981



Darrouzet

Bras articulé complet

MCO978

livré avec MCO978S

Cavalier

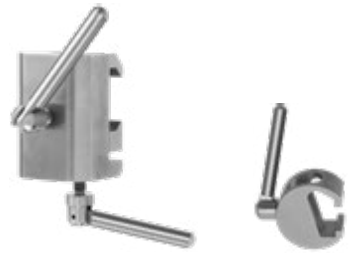

CEV984

CEV985

Accessoires pour Bras articulé

Porte-spéculums

Rotule articulée

Spéculums autostatiques



MCO981



MCO983-4

Devèze



MCO981D



MCO978S

Lucae



7726MF

150mm

7726MF	7727	7728
mors striés 1x12mm	mors curettes	mors à griffes

Politzer



7732-1

120mm

7732-1	7733	7734
mors striés 1,5x14mm	mors curettes	mors à griffes

Echelle 1/2

Pince coudée

Mors striés

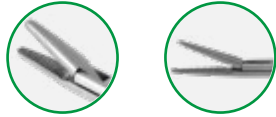

MCEN18	MCEN19
3x8mm	0,9x7mm

Rouvier Pradès

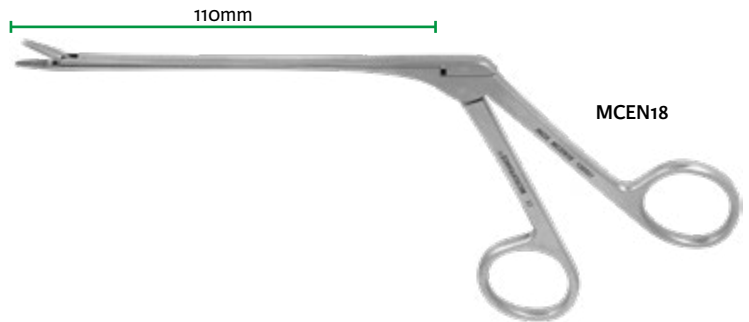

100mm

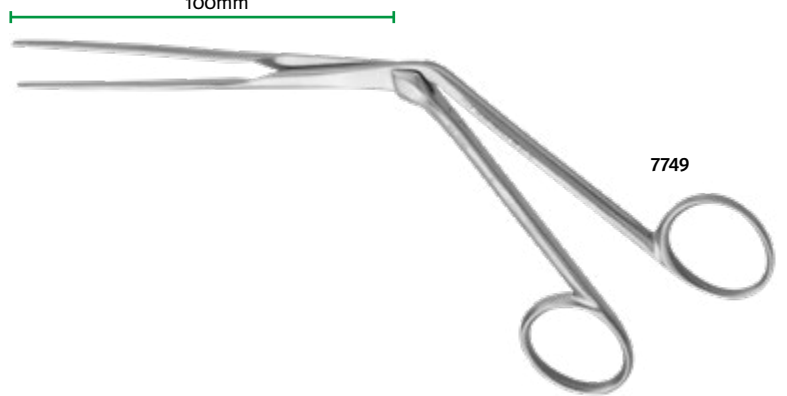

Lubet-Barbon

Mors 60mm

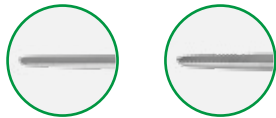

7749	7750
mors lisses	mors striés

Pince mors curettes

Brünings

Pince mors curettes

Pince mors curettes fenêtrées



7761-1	7761-2	7761B-1	7761B-2
7,5mm	9,5mm	7,5mm	9,5mm

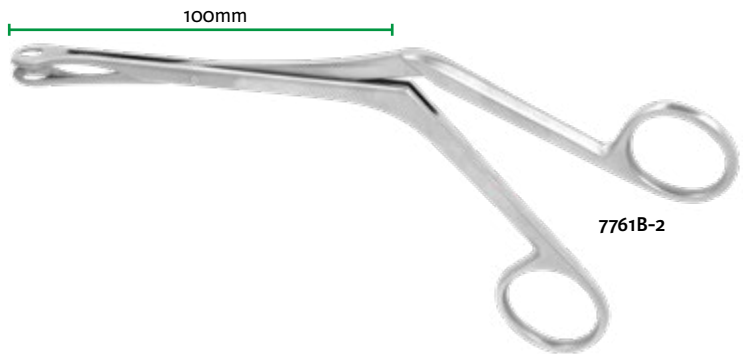

Luc

Pince mors curettes

Pince mors curettes fenêtrées

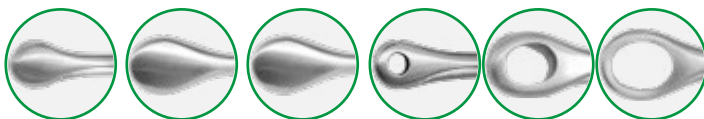

7761C1	7761C2	7761C3	7761BC1	7761BC2	7761BC3
7mm	9mm	11mm	7mm	9mm	11mm

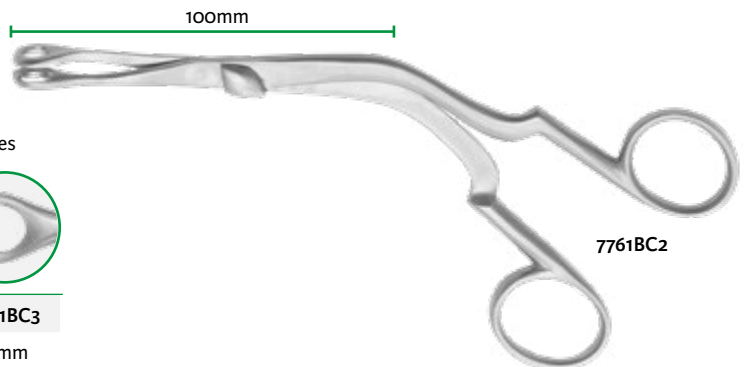

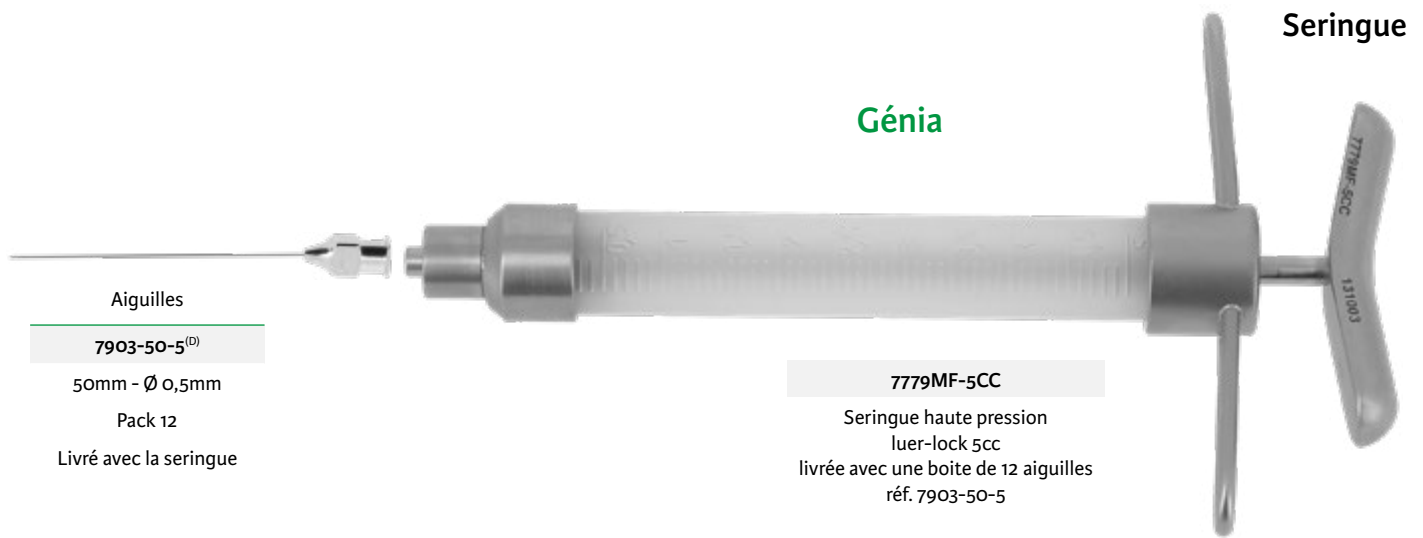

Joint gris embout cône luer

Corps de seringue

Joint blanc piston

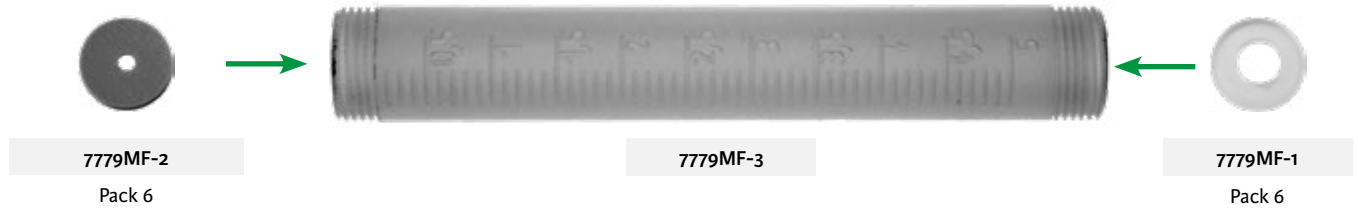

Pousse-seringue



Aiguille à injection



^(D) Distribué par Integra MicroFrance SAS (France) - Voir tableau d'équivalence annexe pour la référence du fabricant correspondante

Sébileau

Fleury

Freer



190mm

CP985

5mm



180mm

MCO305

8,5mm



160mm

MCO803

2,5mm



185mm

CP611

5mm

Howarth



220mm
CP625

Cottle



220mm
CP626

McKenty



240mm
CP627

Rouvier

Orsel

Orsel

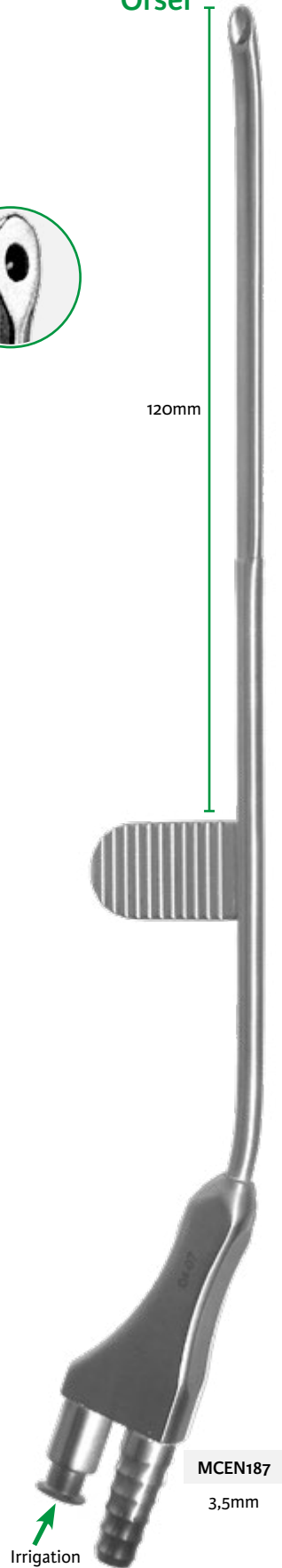
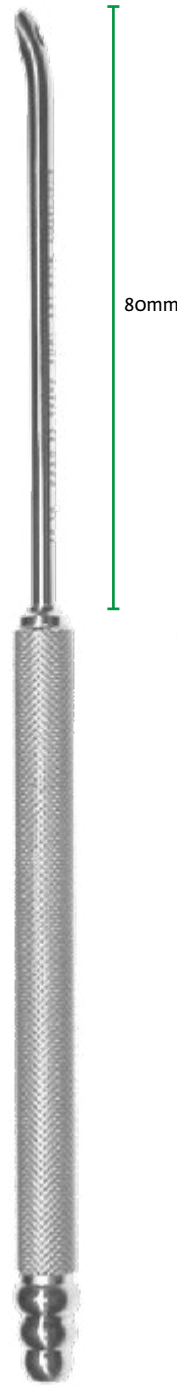
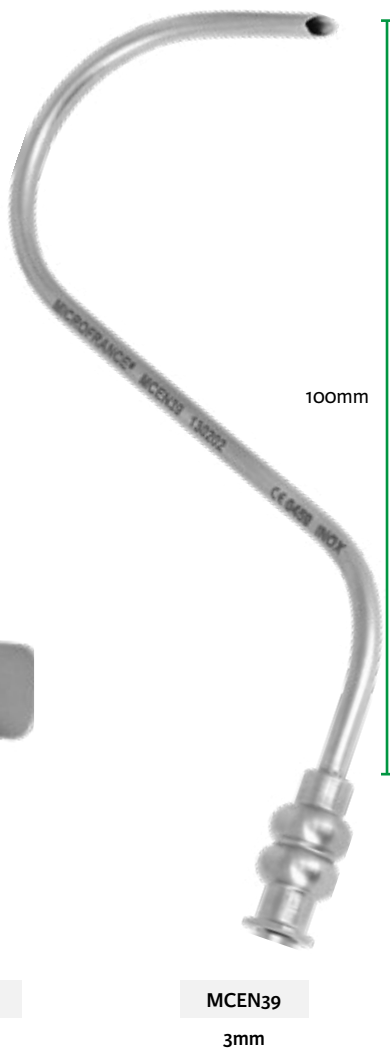
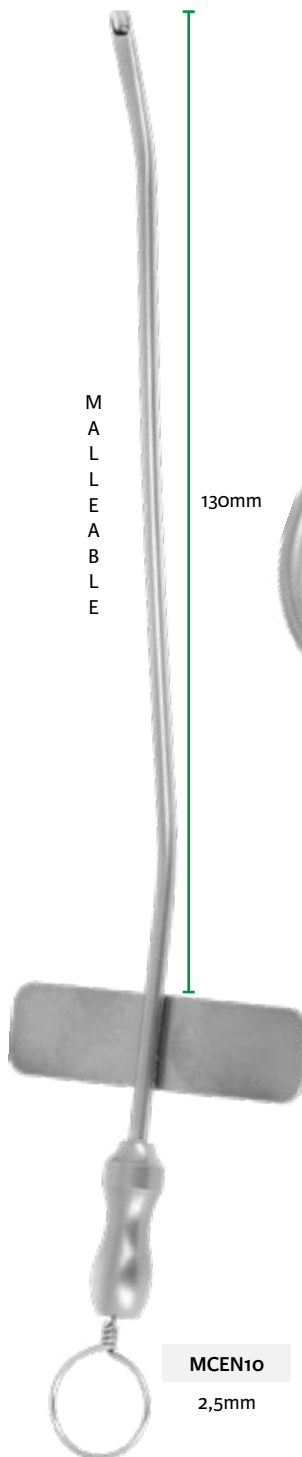

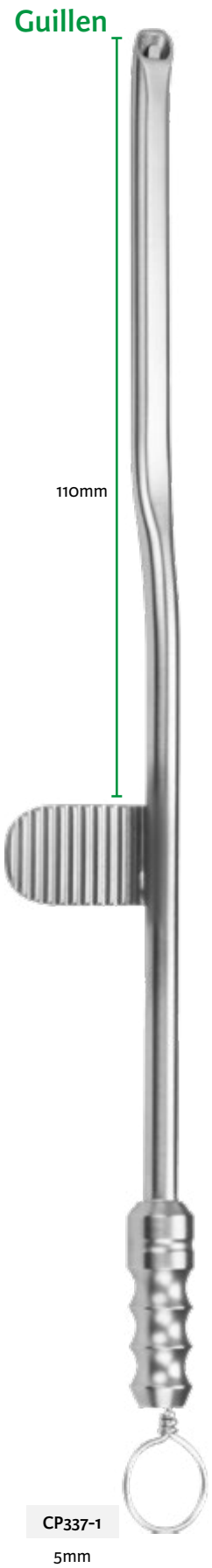
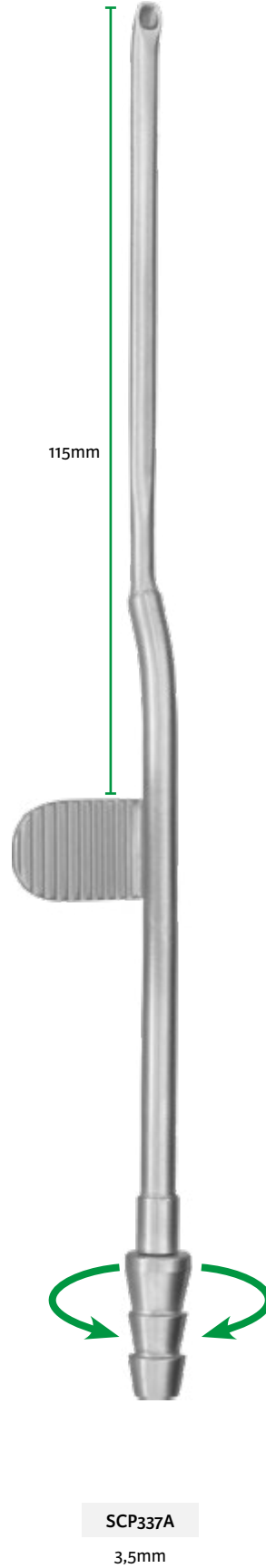
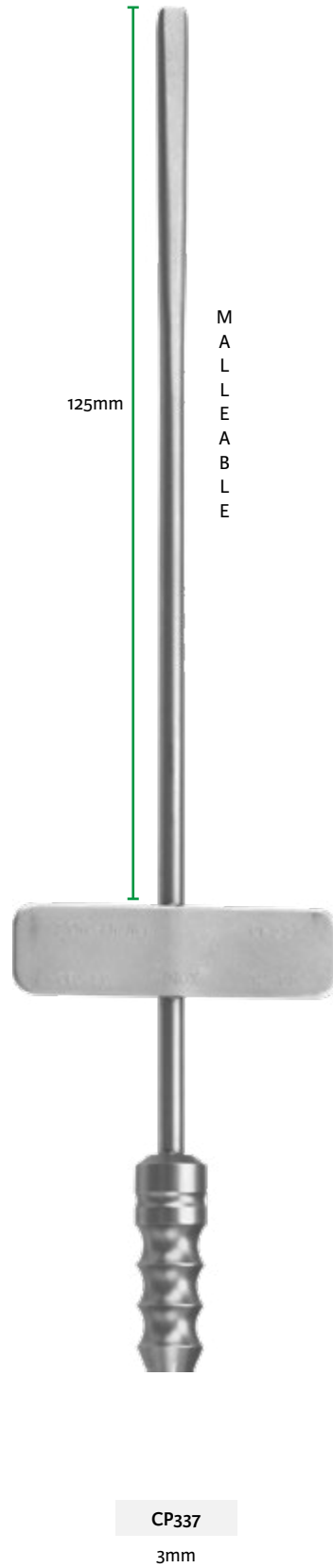



120mm

1003IG^(D)

N° 3



160mm

1005I^(D)

N° 7



200mm

1003LI^(D)

N° 3L



150mm

CP821



120mm

1004IG^(D)

N° 4

lames 23

utilisation avec lames 11/15

^(D) Distribué par Integra MicroFrance SAS (France) - Voir tableau d'équivalence annexe pour la référence du fabricant correspondante

Ballenger



200mm
CP622-4 4mm
215mm
3714164 3mm
3714166 5mm

Joseph



160mm
CP333 coudé

Joseph



160mm
3714678
7mm

Farabeuf

Fleury

Sébileau

Plester



150mm

7787-10

10mm



170mm

MCO979

6,5mm



150mm

CP825

4mm



180mm

MCO988

7,5mm



195mm

3724059

6,5mm

Joseph

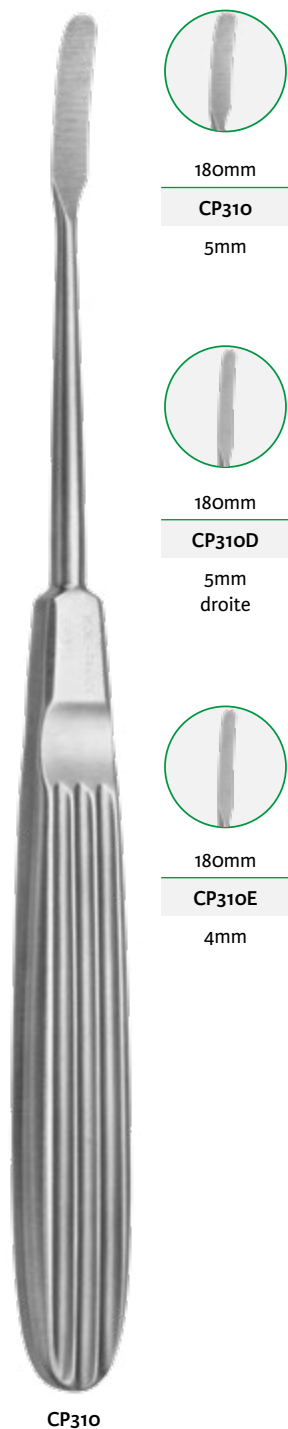

180mm

CP310

5mm

180mm

CP310D

5mm
droite

180mm

CP310E

4mm

CP310

Obwegeser



Obwegeser

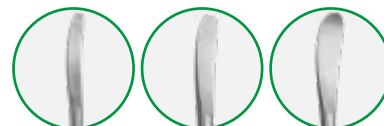

180mm

CP344A

5mm

CP344B

7mm

CP344C

11mm

Obwegeser-Tessier

180mm - tranchante

CP344AT

5mm

CP344BT

7mm

CP344CT

11mm

Obwegeser



190mm

CP344D

7mm
courbe

CP344E

7mm
très courbe

Obwegeser-Tessier

190mm - tranchante

CP344DT

7mm
courbe

CP344ET

7mm
très courbe

CP344A

Farabeuf



140mm 120mm
7768-1 7768
la paire la paire

Desmarres



140mm
CP822-12
12mm
CP822-10
10mm
CP822-14
14mm

Gillies



180mm
CP17
3mm
CP17-1
2mm

Gillies



145mm
CP17-3
2mm
CP17-2
3mm

Humby



110mm
CP941
articulé

Kleinert-Kutz



160mm

3714024	3mm
3714025	5mm
3714026	7mm

Cottle



145mm

3714107	4mm
---------	-----

très courbe

3714108	4mm
3714109	5mm

Sisson



150mm

3714111	6mm
---------	-----

Converse



180mm

3714364	2,5mm
---------	-------

Frazier



130mm

3724256	3,5mm
---------	-------

Knapp



150mm

3714027

8mm

3714028

mousse

Volkmann



140mm

CP21-3

pointu

CP21A-3

mousse



150mm

7782-1-2



180mm

CP335



160mm

CP609

3 griffes pointues

80mm

CP340

Claoué



110mm

CP341

Converse



95mm

CP331

CP331-1

pointu

mousse

Kilner



125mm

CP803

Jost

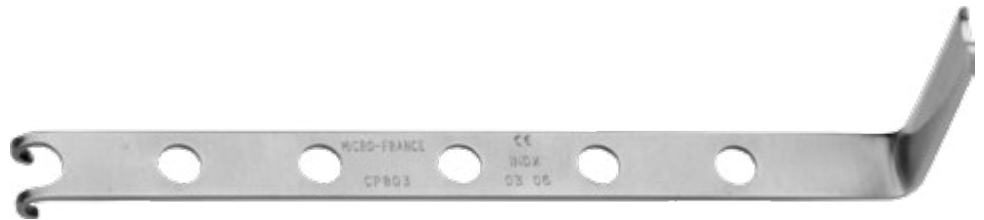

120mm

CP338



130mm

CP339



Aufricht



170mm
CP306 45mm

Cottle



130mm
3714187

Cottle

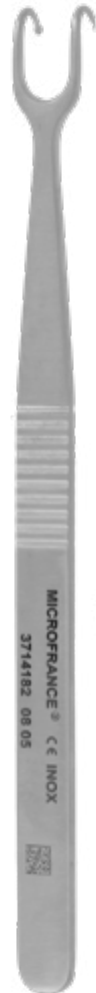

130mm
3714182 pointu à droite
boule à gauche
3714183 pointu à gauche
boule à droite

Joseph



CP23-4
4mm



CP23-6
6mm



CP23-8
8mm



CP23A-8
8mm
mousse



CP23-10
10mm

160mm
CP23-10
10mm



220mm

CP630

Anse et boule

Ragnell



145mm

CP632

Dufourmentel



170mm

CP947



Echelle 1/1

Curette droite

Volkman



CP302-6

170mm

0	CP302-2	2mm	0	CP302-4	4mm	0	CP302-6	6mm
0	CP302-3	3mm	0	CP302-5	5mm	0	CP302-8	8mm



165mm - 110g

MCO995

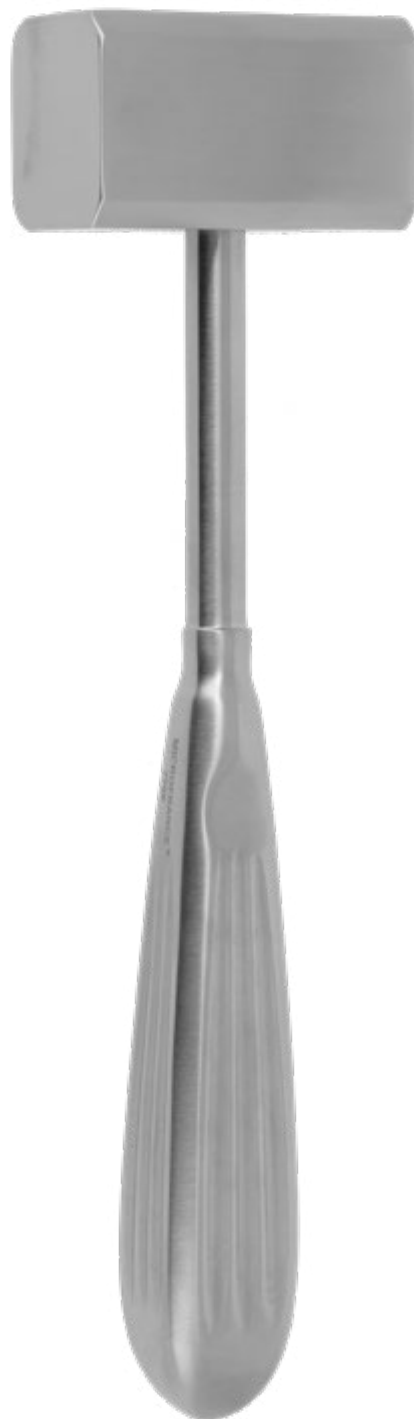

Lombard

185mm - 330g

7766



180mm - 200g

CP907

1 face téflon



180mm - 230g

CP300

Jost



Ballenger



Metzenbaum



Fleury

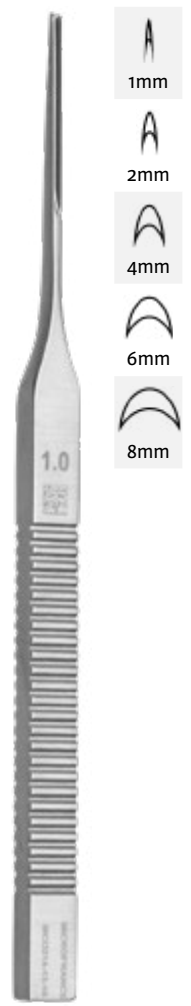

Ciseau burin

Ciseau gouge

droit

180mm

CP801-7	7mm
CP801-10	10mm

droit en V

150mm

3714055	2mm
3714056	4mm
3714057	6mm
3714058	8mm

150mm

3714320	5mm
---------	-----

baïonnette

150mm

CP823-5	5mm
---------	-----

baïonnette en V

150mm

CP824-5	5mm
---------	-----

droit

130mm

MCO214-13-10	1mm
MCO214-13-20	2mm
MCO214-13-40	4mm
MCO214-13-60	6mm
MCO214-13-80	8mm

Aiach



160mm

CP317

16mm

Pollet-Pech



160mm

CP318

13mm

Marchac



180mm

CP304-10

Taille	Courbe	Droit
 2mm	CP304B-2	CP304-2
 3mm	CP304B-3	CP304-3
 4mm	CP304B-4	CP304-4
 5mm	CP304B-5	CP304-5
 6mm	CP304B-6	CP304-6
 7mm	-	CP304-7
 8mm	CP304B-8	CP304-8
 9mm	-	CP304-9
 10mm	CP304B-10	CP304-10
 11mm	-	CP304-11
 12mm	CP304B-12	CP304-12
 14mm	-	CP304-14
 15mm	-	CP304-15
 16mm	-	CP304-16

Tessier

Jost

Marchac

Claoué

Silver



180mm

CP316



180mm

CP802



180mm

CP315



CP315

Pech-Marchac



CP315D
à droite



CP315G
à gauche



180mm

CP305

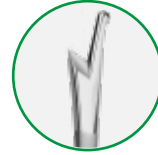

CP305

Lindas

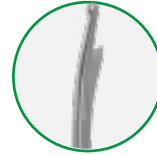

CP305L
à gauche

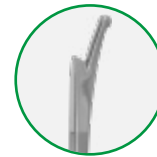

CP305R
à droite



3714098
à droite



3714099
à gauche



180mm

3714098

Mac-Indoe



180mm
CP314-14
14mm

Robin



160mm
CP309-14-16



CP309-8-12
8 - 12mm

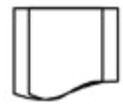

CP309-10-14
10 - 14mm

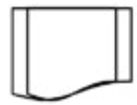

CP309-12-16
12 - 16mm



CP309-14-16
14 - 16mm



CP309-14-18
14 - 18mm

Cottle



195mm
CP808-6
6mm

Cottle



195mm
CP806
6mm

Cottle



190mm
CP807
5mm

Becker

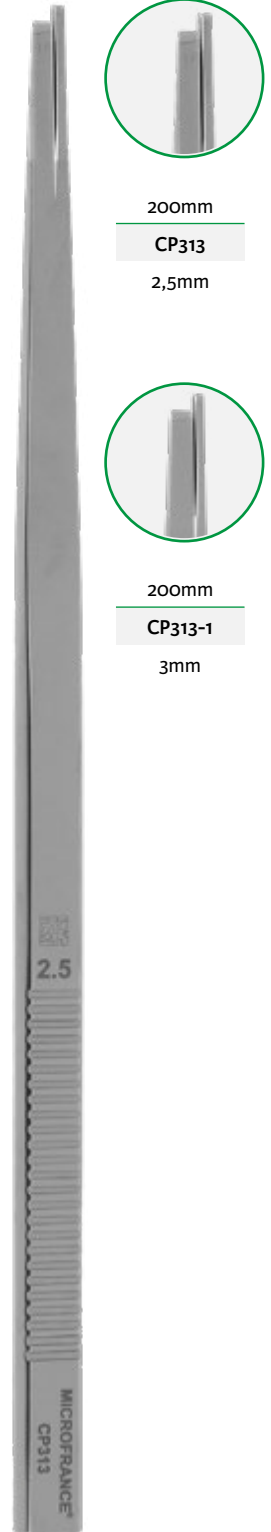

200mm
CP313

Parkès



170mm

3714096

4mm

Maltz



170mm

CP301-1

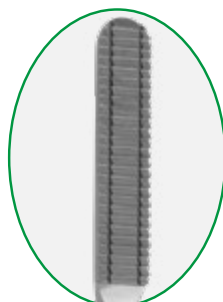

Maltz

CP301-1

8x35mm - en tirant

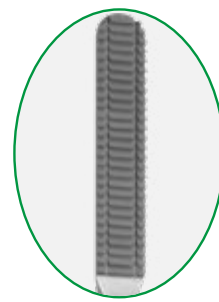

Maltz

CP301

10x45mm - en tirant

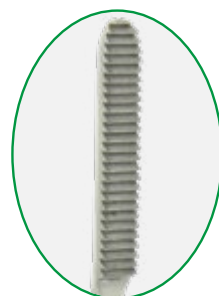

170mm

CP905

8x35mm, concave

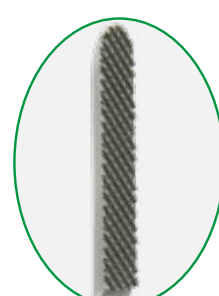

170mm

CP828

8x35mm - en tirant



170mm

CP978

8x35mm, droite, grain d'orge

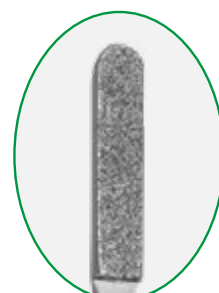

180mm

CP810

8x30mm, droite, diamantée

Aufricht

200mm



CP973

8x25mm
en tirant



CP974

8x25mm
en poussant

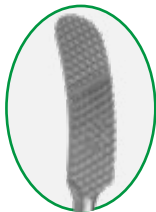

CP976

8x30mm
double action



200mm

CP1100

8x8mm

Bigot



200mm

CP291

4x15mm



190mm

CP998-1

8x12mm
transversale

Fomon

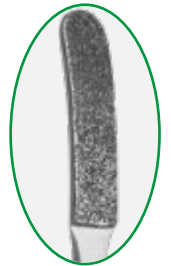

180mm

CP809

8x30mm
Diamantée



175mm

CP301-3

7x20mm
concave
en tirant



180mm

CP301-2

8x30mm
en tirant

Becker

Becker

Fomon

Rees

Gorney

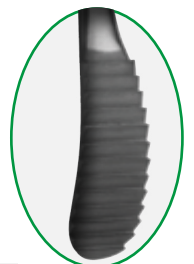
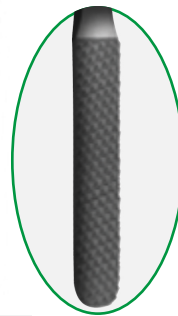

CP301-10

7x38mm
7/8

CP1104

7x20mm
1/2

CP1105

7x20mm
3/4

CP301-4

7x38mm
grain d'orge

CP301-5

7x38mm

CP301-9

7x12mm
8x22mm

Fomon



210mm

Râpe double
gros grains d'orge

3714149 7mm

petits grains
d'orge

3714148 7mm

3714149

Aquaplast

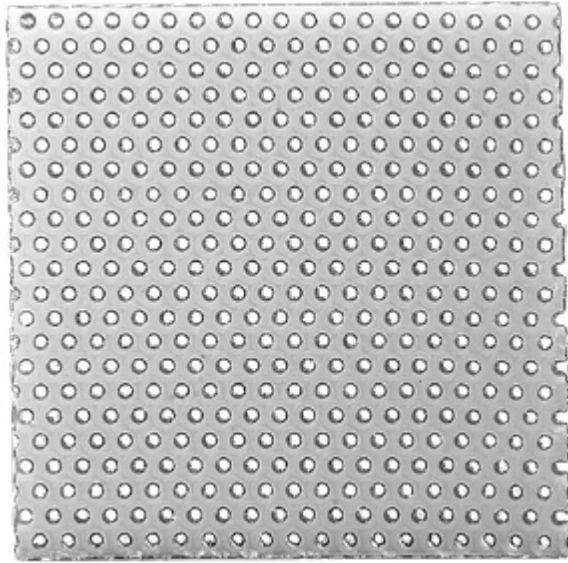

AQ1728^(D)

75x75mm - Pack 10

non stérile, usage unique

^(D) Distribué par Integra MicroFrance SAS (France) - Voir tableau d'équivalence annexe pour la référence du fabricant correspondante

Moule à tympan

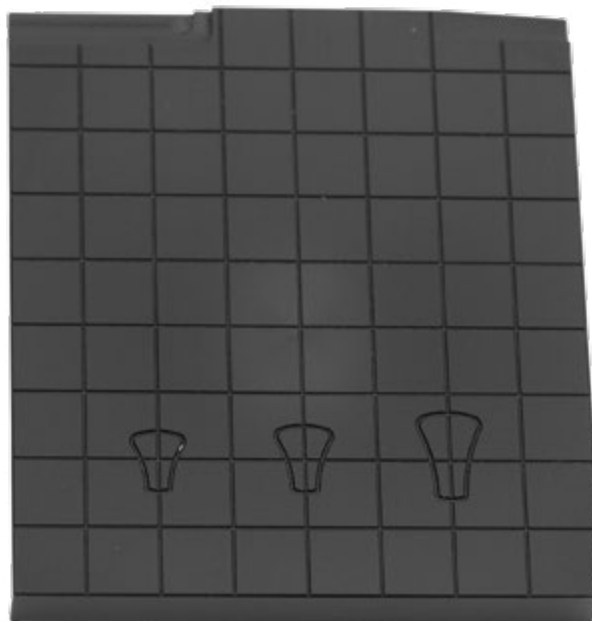

CP1109

80x90mm
avec graduations

Echelle 1/2

Presse-greffe

Jost

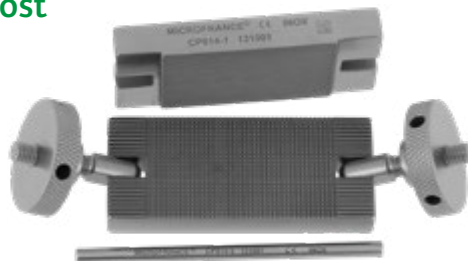

CP814-1

Livré avec clé CP814-3



CP814-2

Plaque lisse 30x50mm
pour CP814-1



CP814-3

Clé de serrage seule
pour CP814-1

Echelle 1/2

Perforateur à os



Stoll



150mm

CP640

Echelle 1/2



Beyer



CP380

160mm

CP380	CP380-2
mors droits 2mm	mors courbes 2mm

Beyer



CP380-3

180mm

CP380-3	CP380-5	CP380-1
mors courbes 2mm	mors courbes 4mm	mors droits 2mm

Jansen-Middleton



180mm

Pince gouge coudée
double articulation

CP621 4x20mm

Pince coupante double articulation

Ruskin



160mm

CP381

Echelle 2/3

Martin



240mm

7765

livré avec 2 mors

Offret

Echelle 3/4



100mm

CP353

forte courbure



100mm

CP356

Streiff

Joseph

Fox



CP16-1

105mm

CP16-1

CP16

lames courbes

lames droites



CP919A

110mm

CP919A

CP919

lames courbes

lames droites



CP358A

110mm

CP358A

CP358

lames courbes

lames droites

Joseph

Kilner-jost



CP354A



120mm - finition mat	
CP354A	CP354
lames courbes	lames droites

120mm - finition mat	
CP362	
Courbe	

Boetcher

Brophy

Joseph



CP367-1

CP355A

180mm

CP997

Courbe

150mm

CP367-1

CP367

Courbe

Droit

150mm

CP355A

CP355

Courbe

Droit

Bregat

Stevens

Stevens



110mm
CP363
lames courbes



110mm
CP922
lames droites



110mm
CP922A
lames courbes

Stevens

Shea

Finition mat

Finition mat



115mm

CP922B

lames courbes modèle «Angers»



120mm

CP637

lames courbes

Reynolds

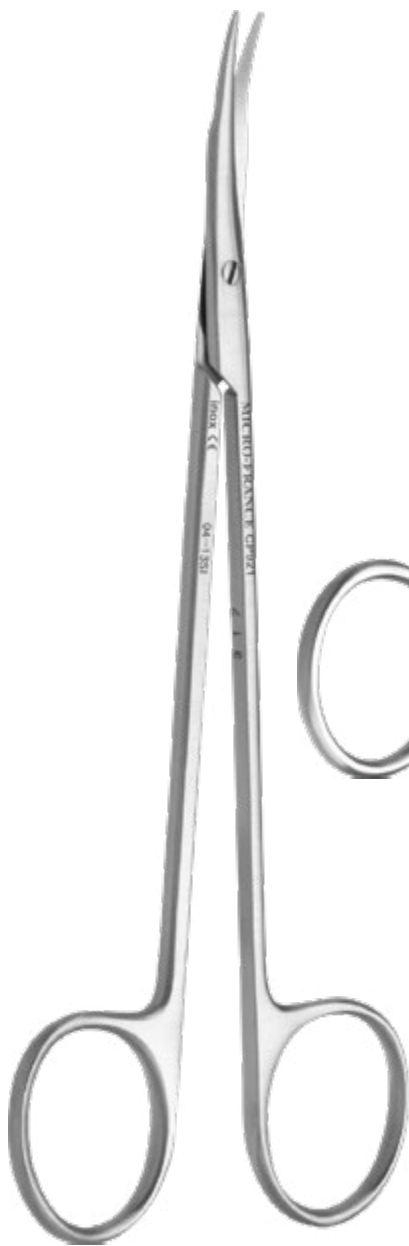

160mm

CP921

Ragnell



150mm

CP616-15



130mm

CP616-13

Joseph



140mm

CP355C

Léger



140mm

CP365

Metzenbaum



110mm

CP351-7	CP351-6
lames courbes	lames droites

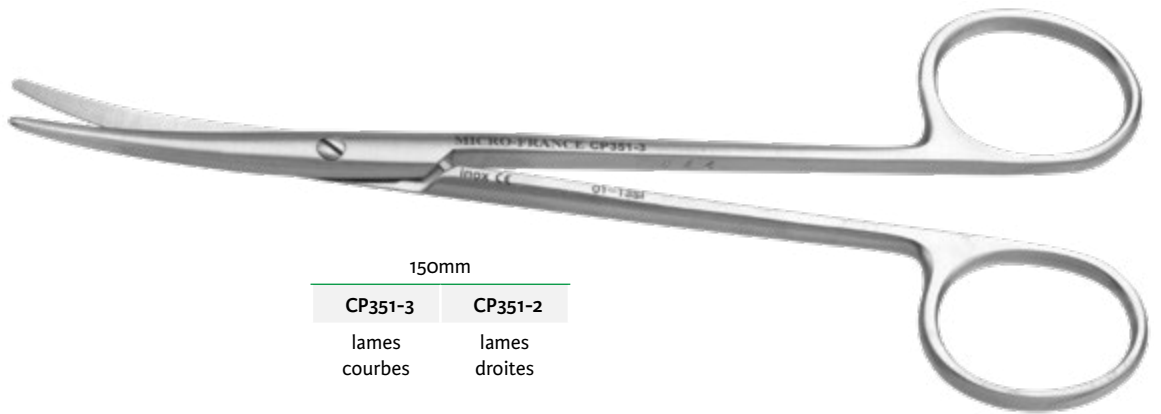

150mm

CP351-3	CP351-2
lames courbes	lames droites

Lames Fines

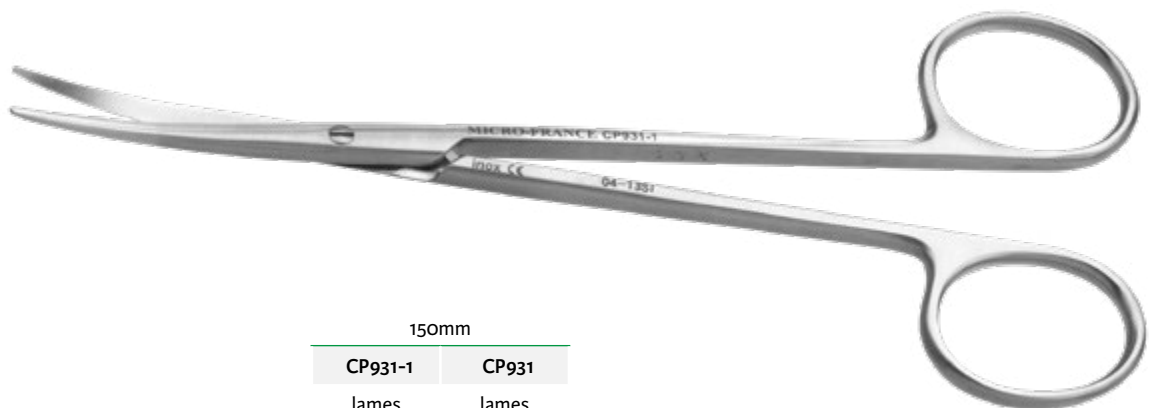

150mm

CP931-1	CP931
lames courbes	lames droites

Mayo



Becker-Converte

100mm

CP1106

lames crantées



Converte

100mm

CP348



Fomon



140mm

CP612

très courbe

Cottle



150mm

CP614

Fomon



140mm

CP613

Cottle-Pech

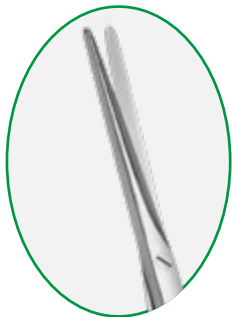

140mm

CP635

Pellegrini

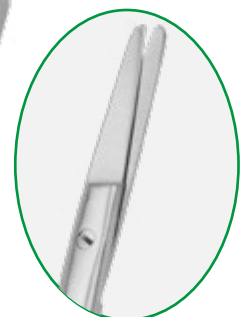

150mm

CP359

lames crantées

Heymann-Klossek

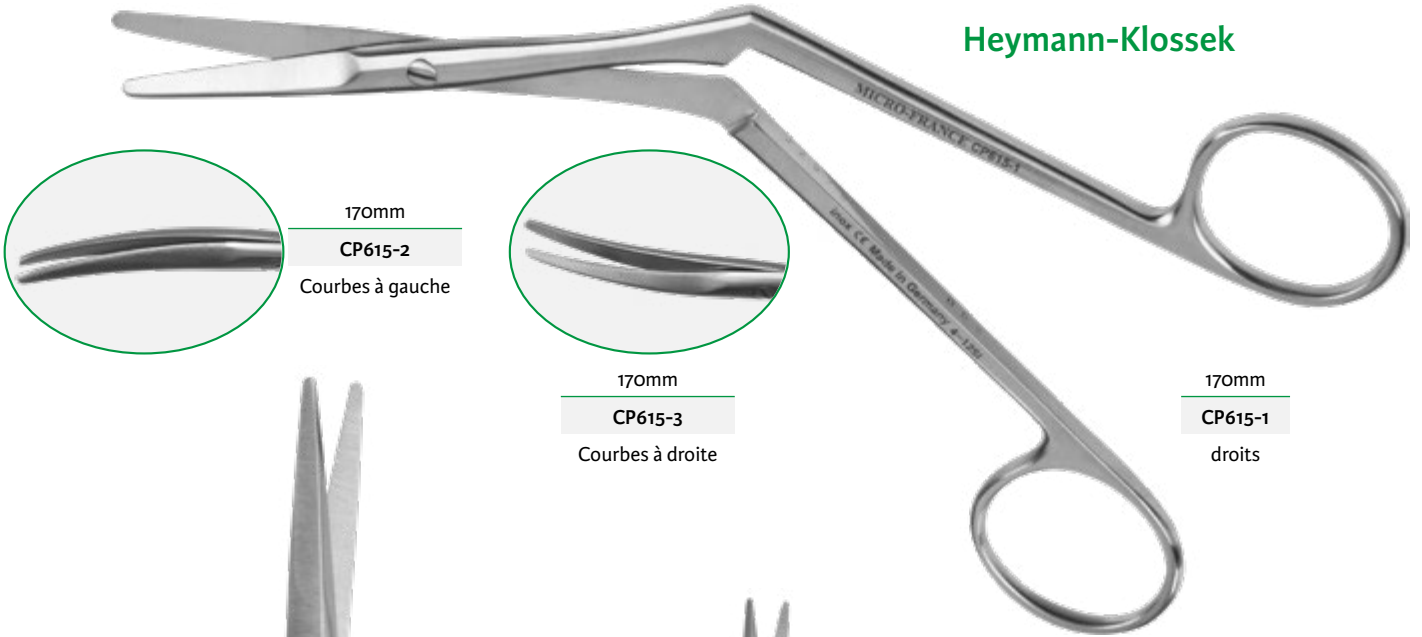

170mm
CP615-2
Courbes à gauche



170mm
CP615-3
Courbes à droite

170mm
CP615-1
droits

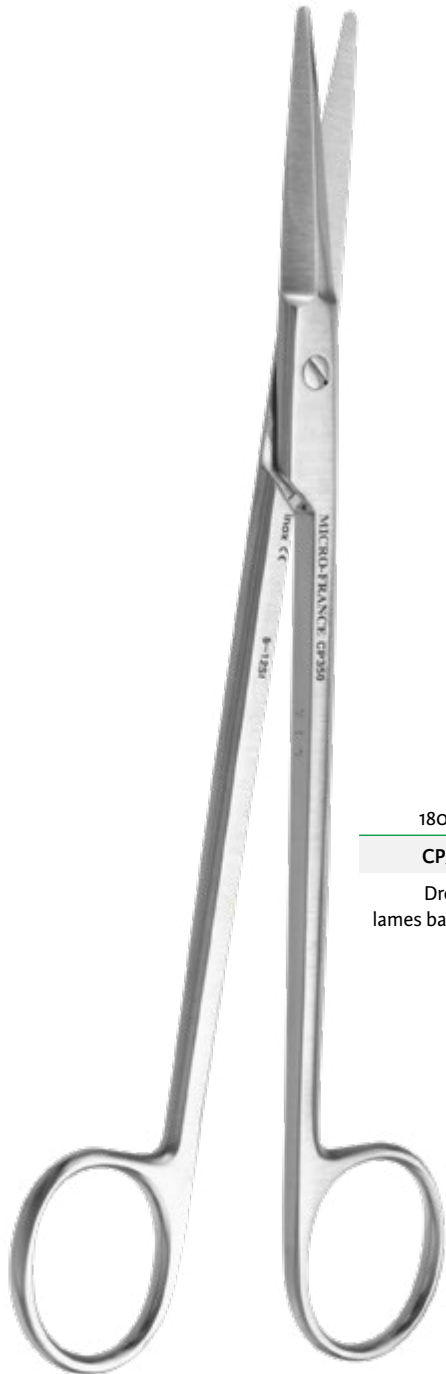

180mm
CP350
Droits
lames baïonnettes

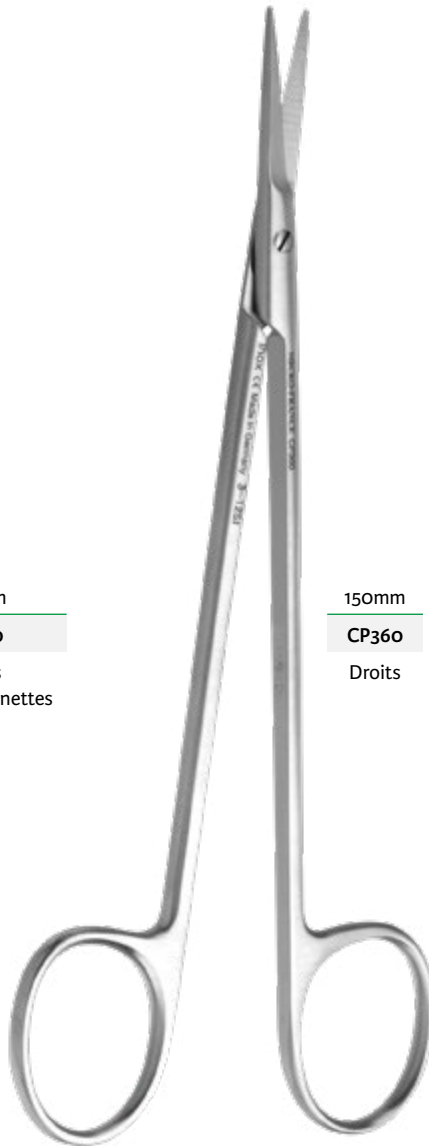

150mm
CP360
Droits



120mm
713T
Coudés
lames tungstène

Bebee

Pince à disséquer 110mm

Castroviejo



CP938-1

Griffes horizontales et plateaux lisses

Castroviejo



CP37

Griffes obliques et plateaux lisses



CP332

Mors striés croisés 1,4mm

Pince à disséquer 120mm



mors striés

CP414

Mors 1mm



7831A-12

Mors 1,5mm



CP406

Mors 1mm



mors à griffes

7833A-12

Mors 1,5mm



CP400-1

5x5 griffes

150mm

Adson



- CP604-15 mors striés 1,5mm
- CP605-15 mors à griffes 1,5mm

Adson-Brown



- CP606-15 mors 7x7 griffes

120mm



Adson-Tubiana

Mors 1mm



Adson

Mors 1,5mm



Mors 1,5mm



Adson-Brown

Mors 7x7 griffes

M832	M833	CP604	CP605	CP606A	CP606
striés	à griffes	striés	à griffes	striés tungstène	

Mac-Indoe

140mm



CP934 Griffes obliques et plateaux striés

CP934-1 Plateaux striés

Debaquey

Barraya

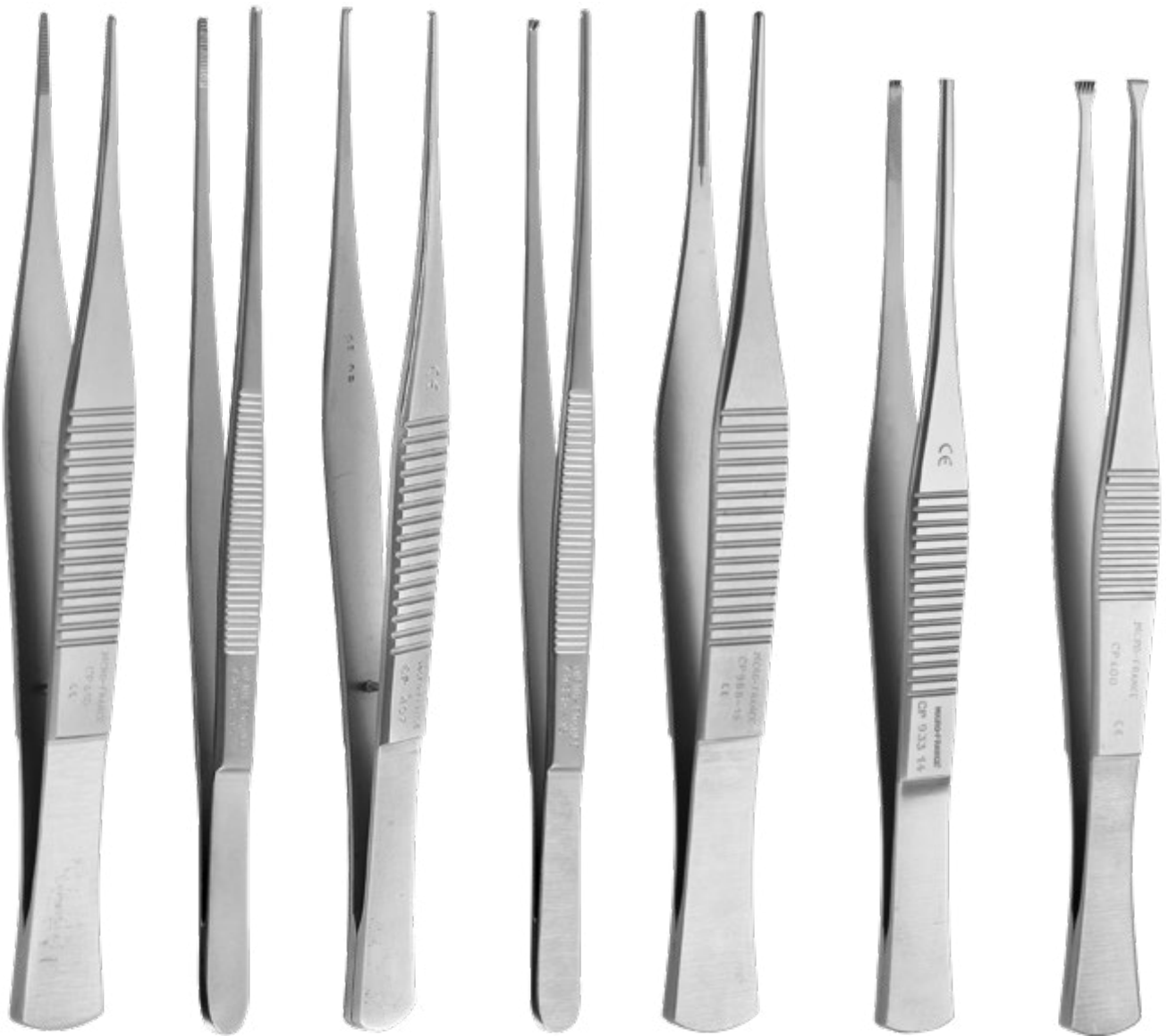

150mm

140mm

CP415	7831A-15	CP407	7833A-15	CP988-15	CP933-14	CP400
Mors striés 1mm	Mors striés 1,5mm	Mors à griffes 1mm	Mors à griffes 1,5mm	Mors 1,5mm	3x4 griffes et plateaux striés	Mors 5x5 griffes

Précelle



150mm

CP345

striée

Barraya



160mm

CP933-16

3x4 griffes
et plateaux striés

Claoué



160mm

CP401

5x6 griffes

Mac-Indoe



170mm

CP936

1x2 griffes
et plateaux striés

Debaquey



1,5mm
7831A-18



1,5mm
CP988-18



1mm
CP409
1x2

Barraya



1,5mm
7833A-18
1x2



1,5mm
CP933-18
3x4 et plateaux striés



6x6
CP400-2

Debaquey



200mm 210mm

7832 7834

1mm 1mm
mors striés 1x2 griffes



2mm

7831A-20



1,5mm

CP988-20



2mm

7833A-20

1x2



Magnan

Adson

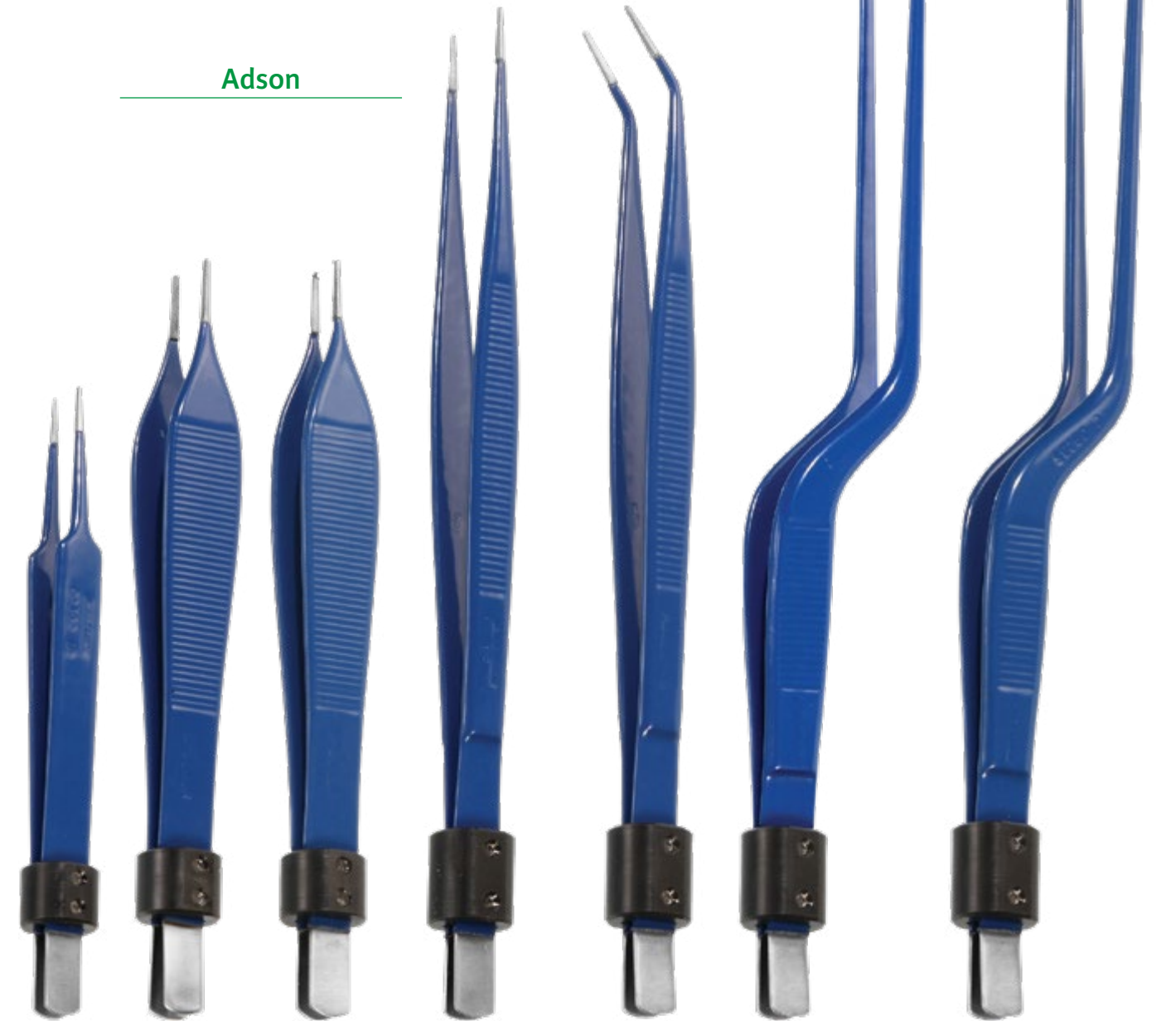

110mm		120mm		160mm		200mm	
CP392-1R	CP604BR	CP605BR	CP392-2R	CP392-8R	CP392BI	CP392BS	
Mors lisses 1x8mm	Mors striés 1,5mm	Mors à griffes 1,5mm	Mors lisses 1x8mm	Mors lisses 1x8mm	Mors lisses 0,5x5mm	Mors lisses 0,5x5mm	



Adson



110mm

CP390-1

Mors lisses
1x8mm



120mm

CP604M

Mors striés
1,5mm



CP605M

Mors à griffes
1,5mm



160mm

CP390-2

Mors lisses
1x8mm



CP390-8

Mors à griffes
1x8mm

Halsey

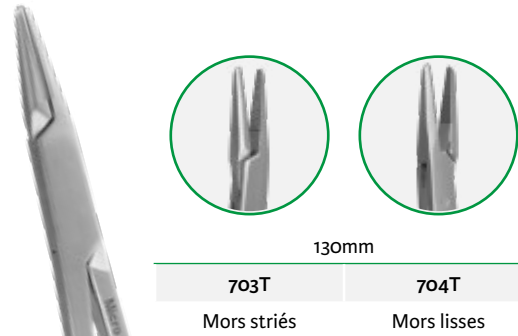

130mm

703T

Mors striés

704T

Mors lisses

Crile-Wood

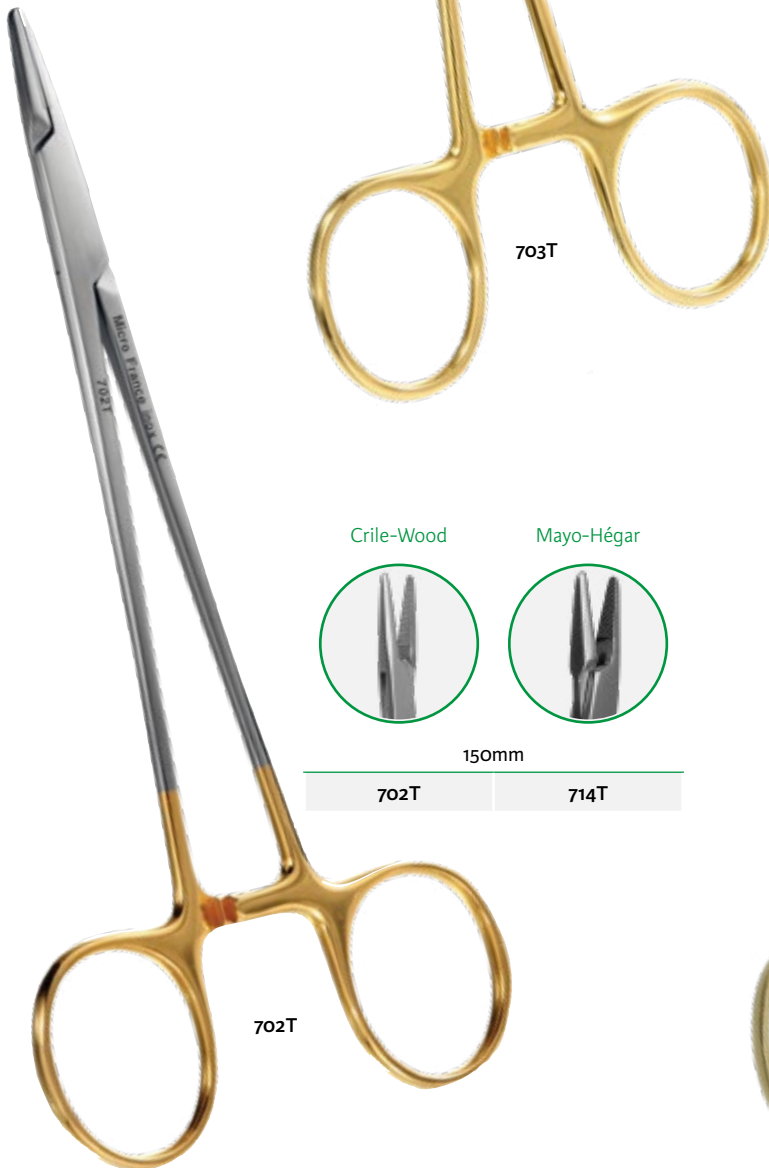

Crile-Wood

Mayo-Hégar

150mm

702T

714T

Becker

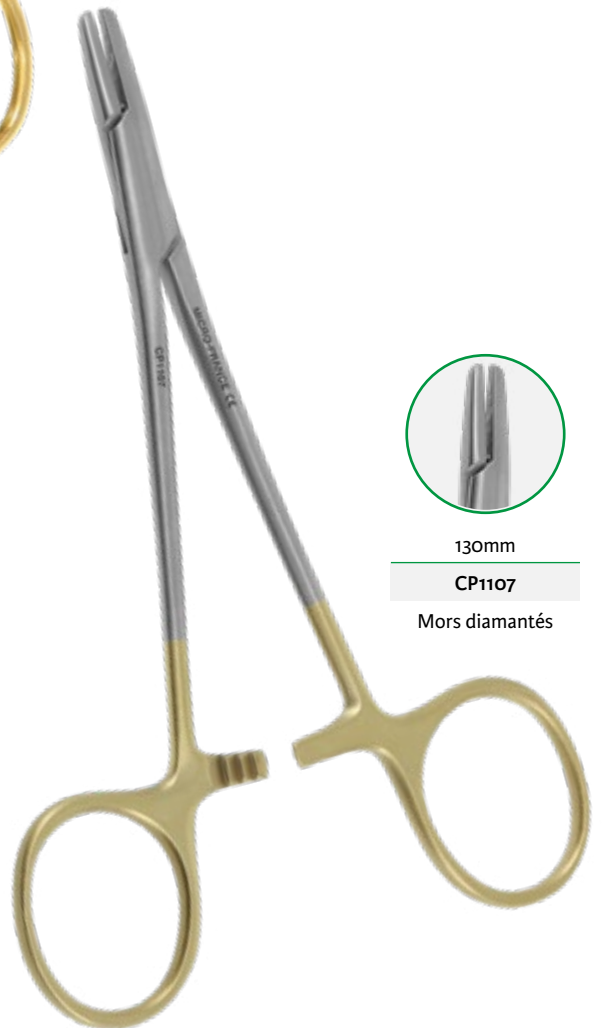

130mm

CP1107

Mors diamantés

Leriche

140mm - sans griffe

7867-1	7867-2
--------	--------

Droite	Courbe
--------	--------

140mm - à griffes

7867-3	7867-4
--------	--------

Droite	Courbe
--------	--------



7867-1

Halsted

120mm - à griffes

P761-7	P761-8
--------	--------

Droite	Courbe
--------	--------



P761-7

Kelly

Sans griffe

140mm	160mm
-------	-------

P762-2	P762-4
--------	--------

Courbe	Courbe
--------	--------



P762-2

Kocher

140mm	160mm	180mm
-------	-------	-------

Droite sans griffe

P764-1	P764-5	-
--------	--------	---

Droite à griffes

P764-3	P764-7	P764-11
--------	--------	---------



P764-3



Martel

130mm

P763

Pince striée
à griffes en «T»



Péan

140mm 160mm

P765-14 P765-16

Pince hémostatique
striée

P765-14



Terrier

130mm

P769

Pince hémostatique
mors striés



Chaput

130mm

7866-13

2x3 griffes

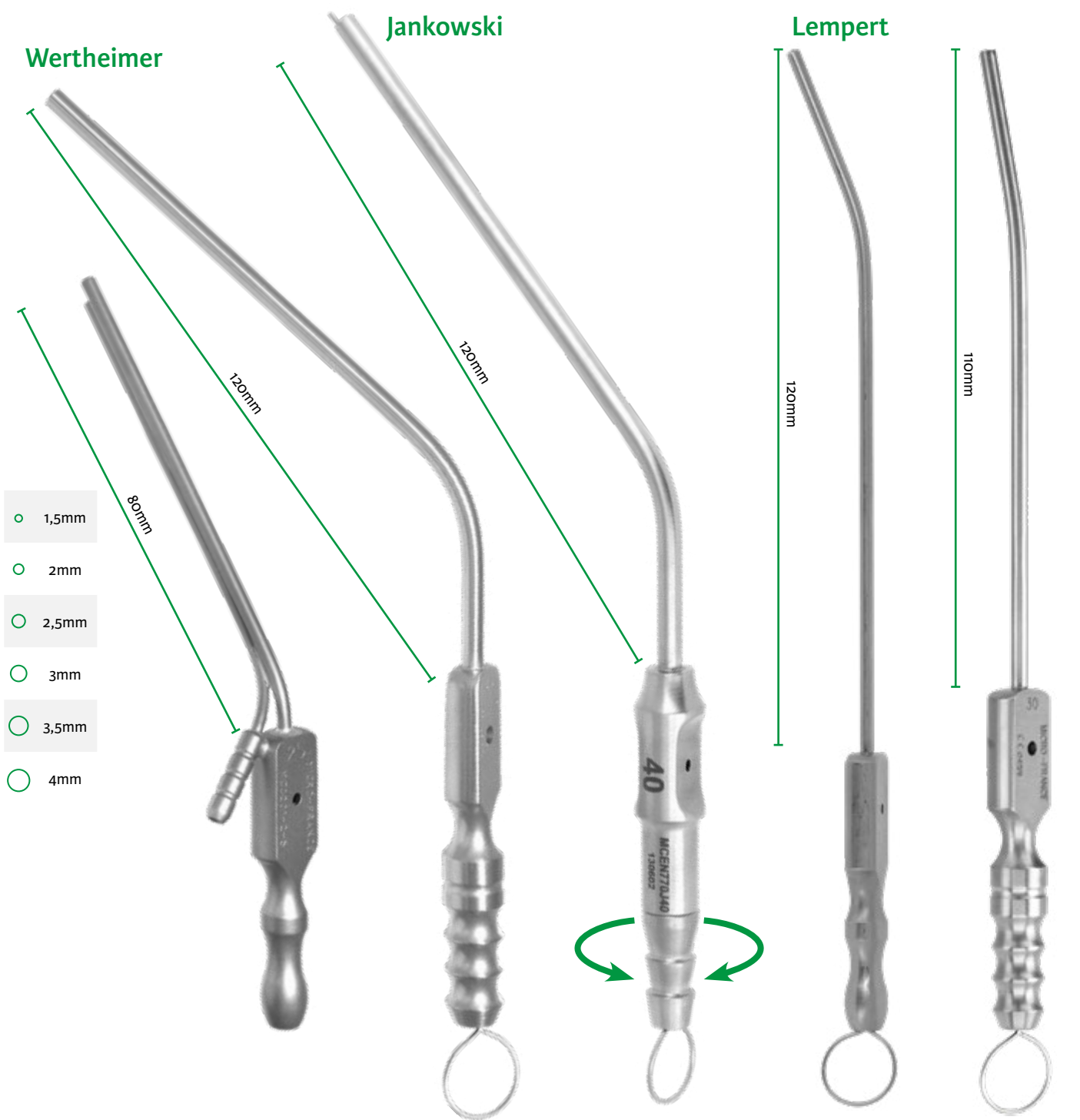

- 1,5mm
- 2mm
- 2,5mm
- 3mm
- 3,5mm
- 4mm

Wertheimer		Jankowski		Lempert	
MCO201-2-5	2,5mm	MCO770-1-5	1,5mm	MCO771-2-5	2,5mm
MCO201-3-0	3mm	MCO770-2-0	2mm	MCO771-3-0	3mm
		MCO770-2-5	2,5mm	MCO771-4-0	4mm
		MCO770-3-0	3mm		
		MCO770-3-5	3,5mm		
		MCO770-4-0	4mm		
		MCEN770J40	4mm	CP330-3-0	3mm
		MCEN770J30	3mm	CP330-4-0	4mm

Raccord luer-lock

Manche aspirateur

Benezeth

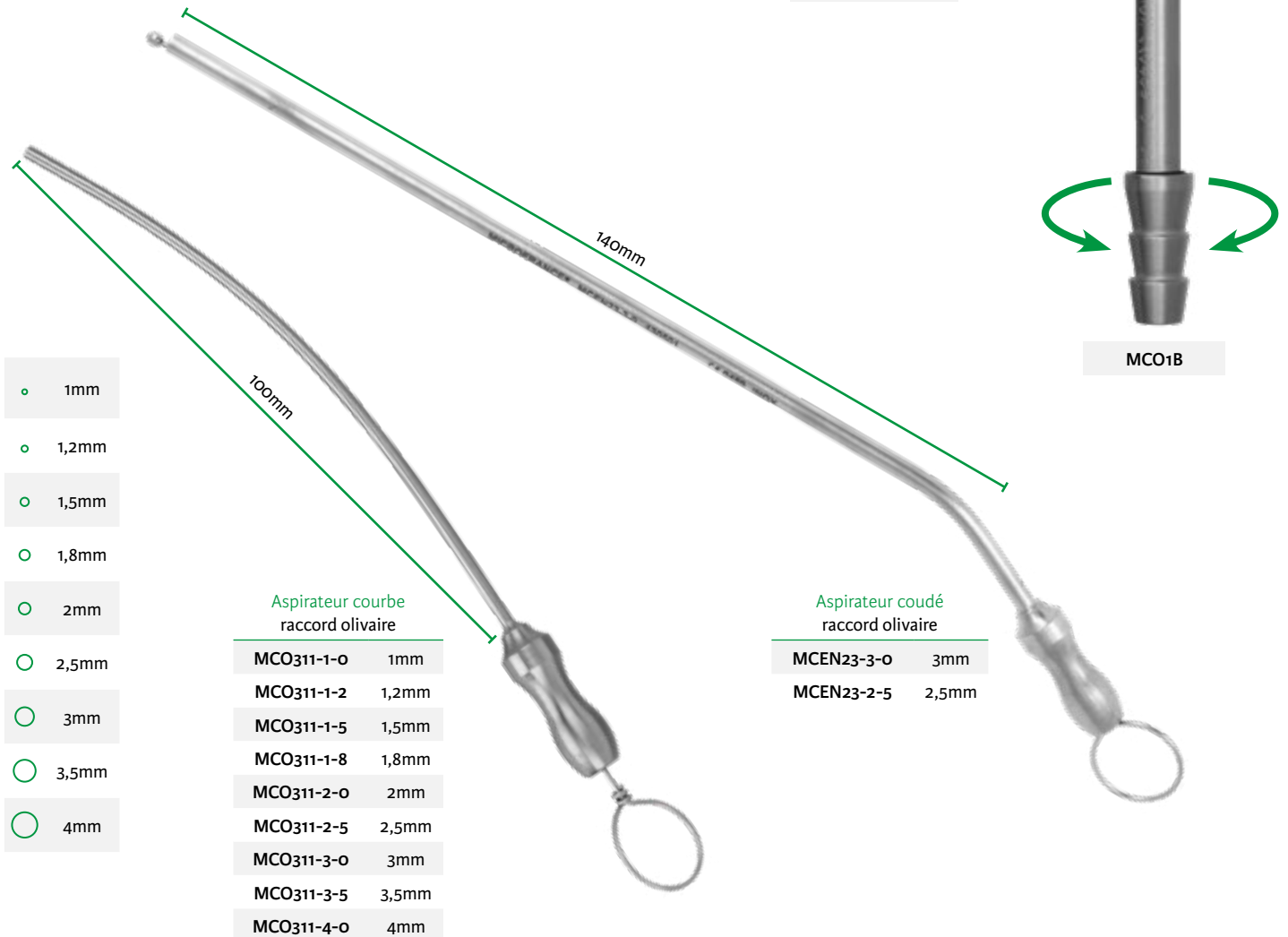
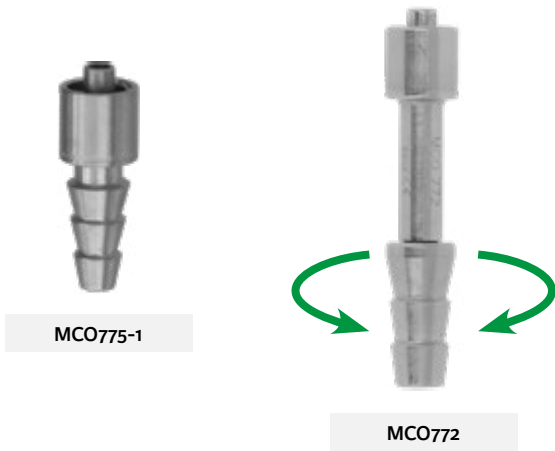

- 1mm
- 1,2mm
- 1,5mm
- 1,8mm
- 2mm
- 2,5mm
- 3mm
- 3,5mm
- 4mm

110mm

MCEN37-1-20	2mm
MCEN37-1-25	2,5mm
MCEN37-1-30	3mm
MCEN371D35	3,5mm
MCEN371D4	4mm

Malléable

MCEN37-2-0	2mm
MCEN37-2-5	2,5mm
MCEN37-3-0	3mm
MCEN37-3-5	3,5mm
MCEN37D4	4mm

De Gabory

Poignée de commande pour aspirateur raccord Luer-Lock

MCEN103LDG

Echelle 2/3

MCEN103LDG

Marche - Arrêt

120mm

MCEN770B25	2,5mm
MCEN770B30	3mm



MCEN77-3-0	3mm
MCEN77-3-5	3,5mm

Jankowski

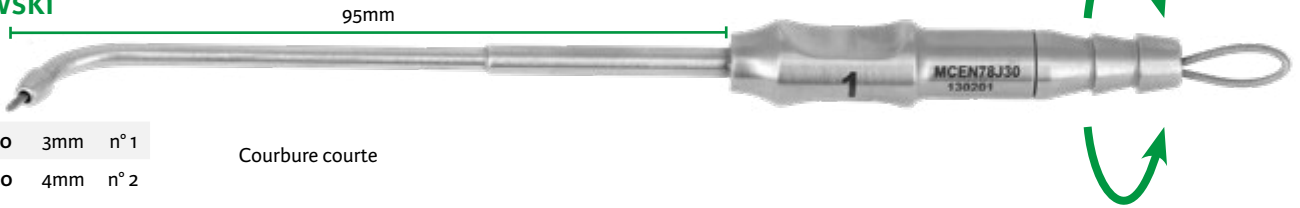

MCEN78J30	3mm	n° 1
MCEN78J40	4mm	n° 2

Courbure courte

Jankowski



MCEN79J25	2,5mm	n°3
MCEN79J30	3mm	n°4
MCEN79J40	4mm	n°5

Orsel

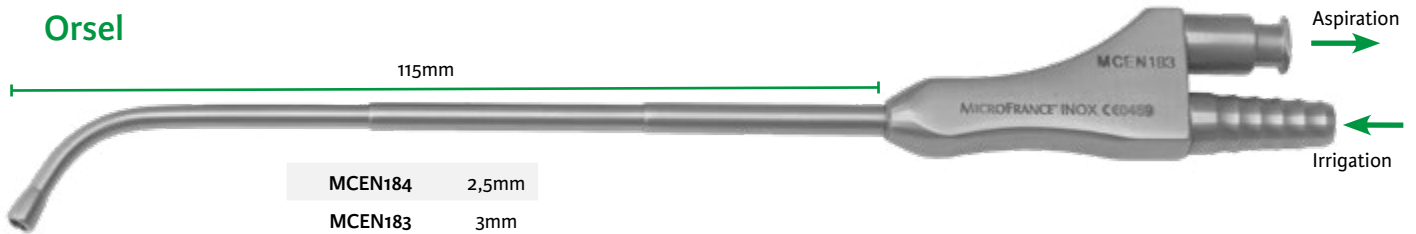

MCEN184	2,5mm
MCEN183	3mm

Orsel

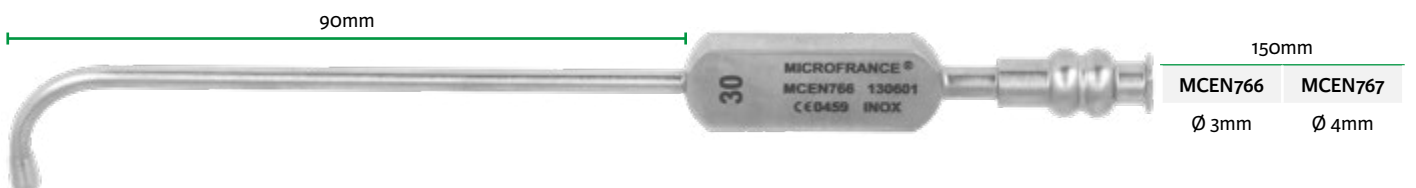

150mm	
MCEN766	MCEN767
Ø 3mm	Ø 4mm

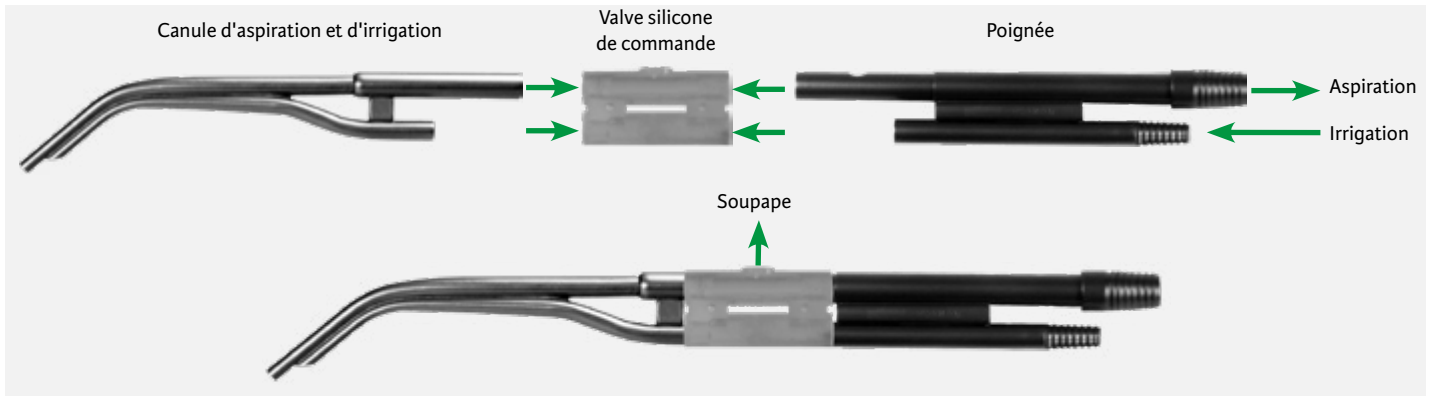

Poignée
livrée avec valve silicone

1375012



Micro aspirateur irrigateur sans soupape

Référence	Longueur utile	Taille fr	Taille mm
1375020	100mm	10X10	3,3 X 3,3



Micro aspirateur irrigateur avec soupape

Référence	Longueur utile	Taille fr	Taille mm
1375025	100mm	10X10	3,3 X 3,3



1375025

1375101 90mm 5X4 1,67 X 1,35

1375102 90mm 4X4 1,35 X 1,35

1375103 90mm 4X3 1,35 X 1

1375107 90mm 7X7 2,3 X 2,3

1375110 90mm 10X7 3,3 X 2,3

1375114 90mm 14X7 4,7 X 2,3

1375201 120mm 5X4 1,67 X 1,35

1375207 120mm 7X7 2,3 X 2,3

1375210 120mm 10X7 3,3 X 2,3

1375214 120mm 14X14 4,7 X 4,7

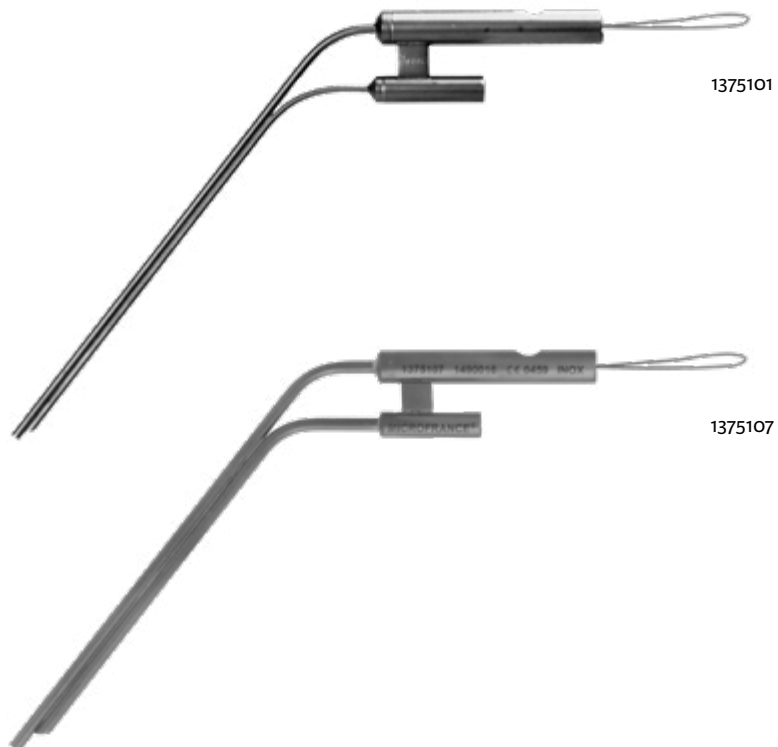

1375101

1375107

Accessoires du rhinolaveur de Dessi



Tubulure irrigation
stérile
usage unique

MCEN84S^(D)

Pack 20

Utilisable avec la pompe
d'irrigation MCEN8o

Echelle 2/3

- 0° MCEN83-C
- 30° MCEN81-C
- 45° MCEN87C
- 70° MCEN82-C

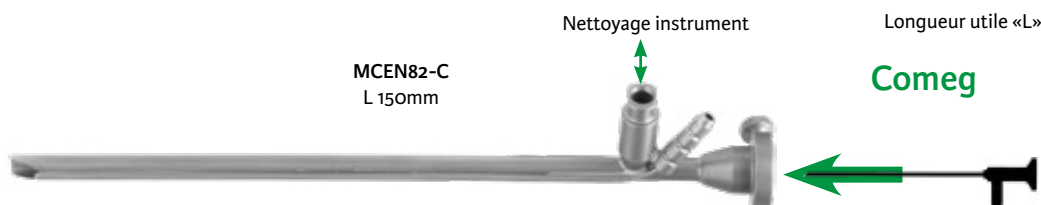

	L 140mm	L 125mm			
0°	MCEN83O	MCEN83OL	pour optique (WA96200A)	-	-
30°	MCEN81O	MCEN81O1	(WA96201A)	MCEN81O2	pour optique (WA96202A)
45°	-	MCEN87O3	(WA96203A)	MCEN87O4	(WA96204A)
70°	MCEN82O	MCEN82O5	(WA96205A)	MCEN82O6	(WA96206A)

- 0° MCEN83-S
- 30° MCEN81-S
- 45° MCEN87-S
- 70° MCEN82-S



- 0° MCEN83-W
- 25° MCEN81-W
- 30° MCEN81-W
- 45° MCEN87W
- 70° MCEN82-W

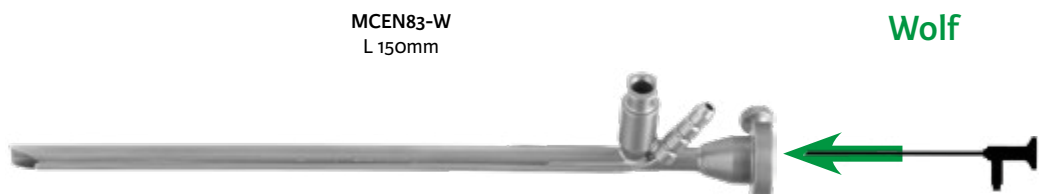

Chemise pour optique variable

MCEN88SC

pour optique : modèle :
Olympus WA9T400V
Sopro Comeg Ulyss



^(D) Distribué par Integra MicroFrance SAS (France) - Voir tableau d'équivalence annexe pour la référence du fabricant correspondante

Echelle 2/3

Trocart et canule

Longueur utile «L»

Rouvier

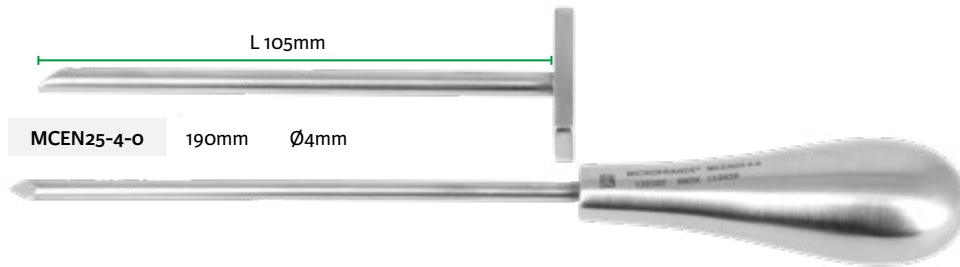

Pince mors curettes pour trocart MCEN25-4-0

MCEN28

2 mors mobiles
2x5mm

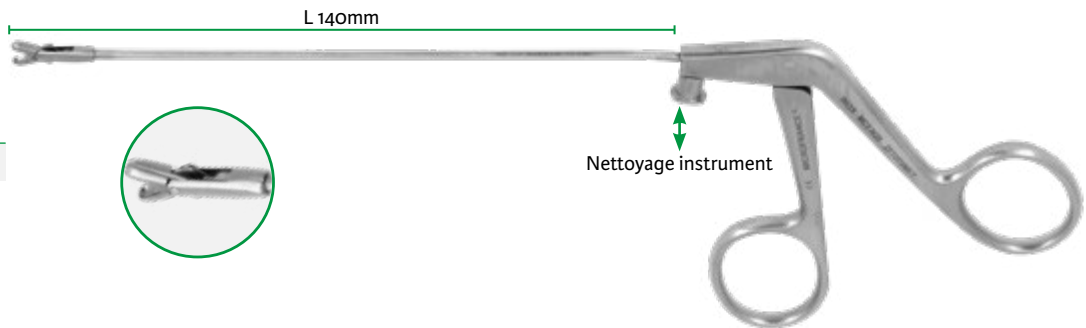

Albertini

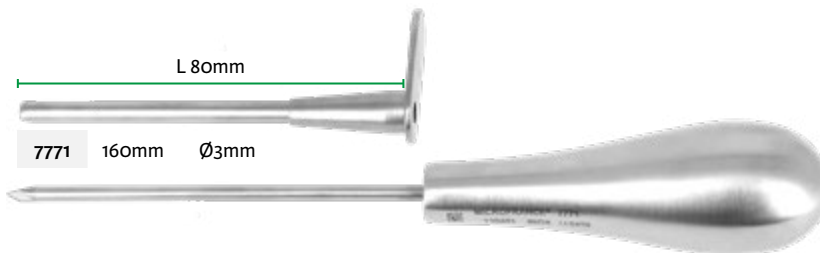

Guide passe drain

Albertini

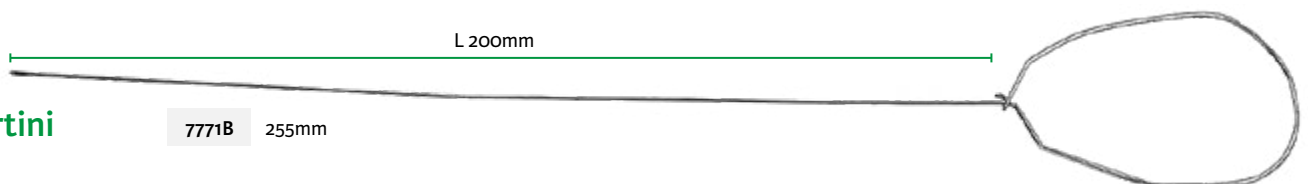

Pradès

220mm

MCEN55

7,5mm



Gillies

230mm

3714379

7mm

Micro palpateur double courbe boule

Pointe



190mm

MCEN713

boule
Ø 2,3mm



160mm

1352431

Ø 0,6mm
pointe "champignon"

Herman

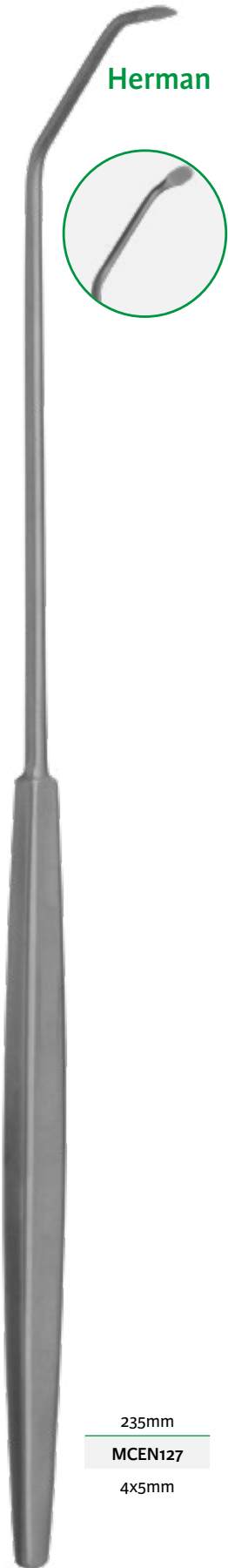

235mm
MCEN127
4x5mm

Friedrich



180mm
MCEN44
9mm

Rouvier



180mm
MCEN50
bistouri et
décolleur

Lérault



190mm
MCEN103
décolleur
coudé
3mm

Echelle 2/3

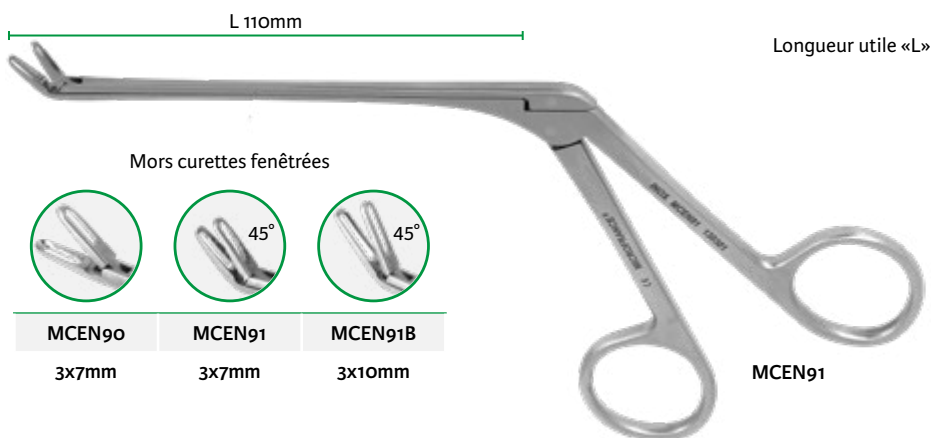

Mors curettes ajourées



MCEN33

3x6mm

MCEN34

3x6mm

Mors curettes fenêtrées



MCEN90

3x7mm

MCEN91

3x7mm

MCEN91B

3x10mm

Blakesley-Klossek

Mors curettes ajourées 3mm



MCEN56

à droite

MCEN56-1

à gauche

Klossek

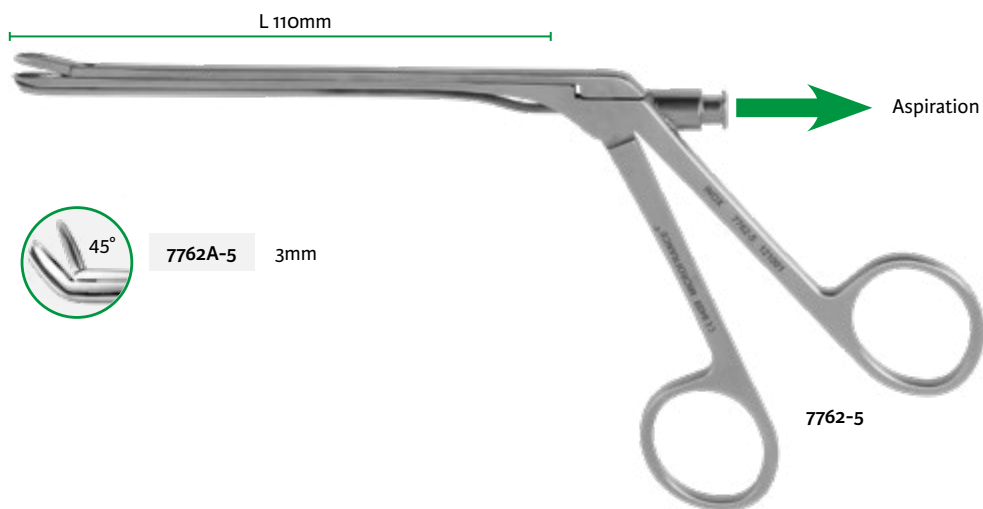

7762-5

3mm



7762A-5

3mm

Dessi



0°



45°



90°

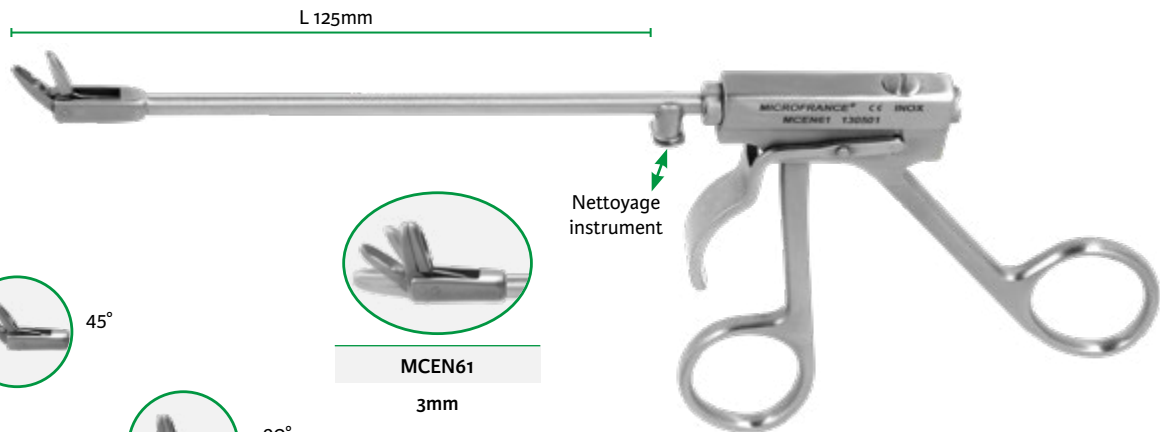

De Gabory

Echelle 2/3
Longueur utile «L»

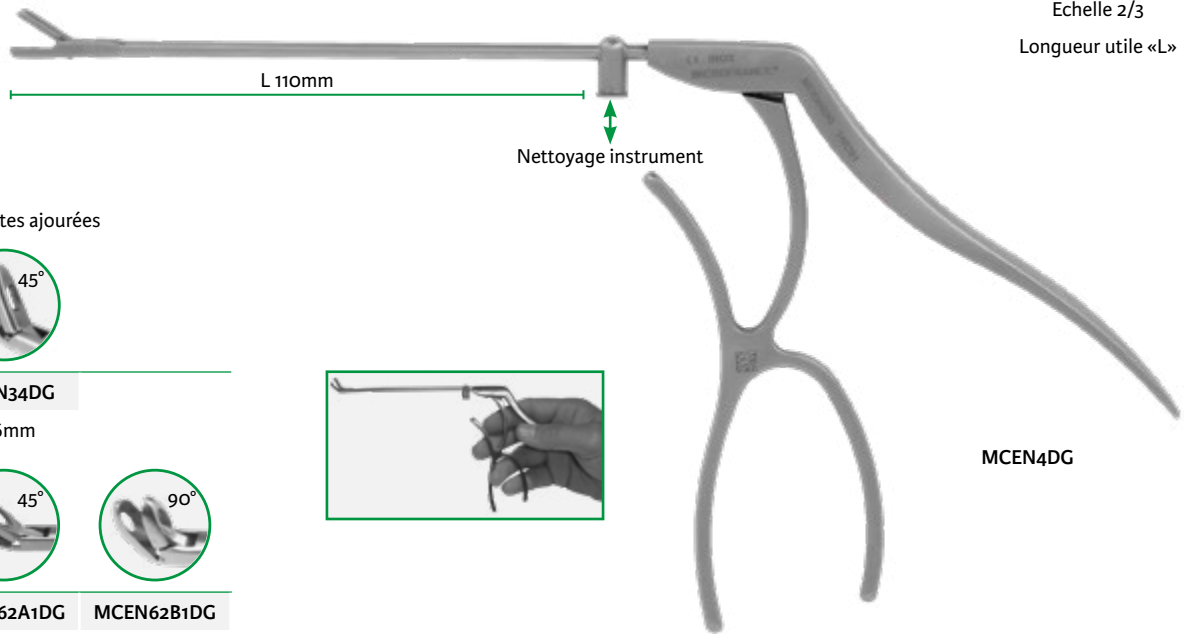

Mors curettes ajourées



MCEN33DG
3x6mm

MCEN34DG
3x6mm



MCEN62T1DG
3x8mm

MCEN62A1DG
3x8mm

MCEN62B1DG
3x8mm



MCEN62T2DG
5x11mm

MCEN62A2DG
5x11mm

MCEN62B2DG
5x11mm

Mors curettes fenêtrées



MCEN90DG
3x7mm

MCEN91DG
3x7mm

MCEN91BDG
3x10mm

Mors curettes



MCEN4DG
3x6mm

MCEN5DG
3x6mm

MCEN5BDG
3x12mm

Poignée stylet "K" pour insert mors curettes et tube

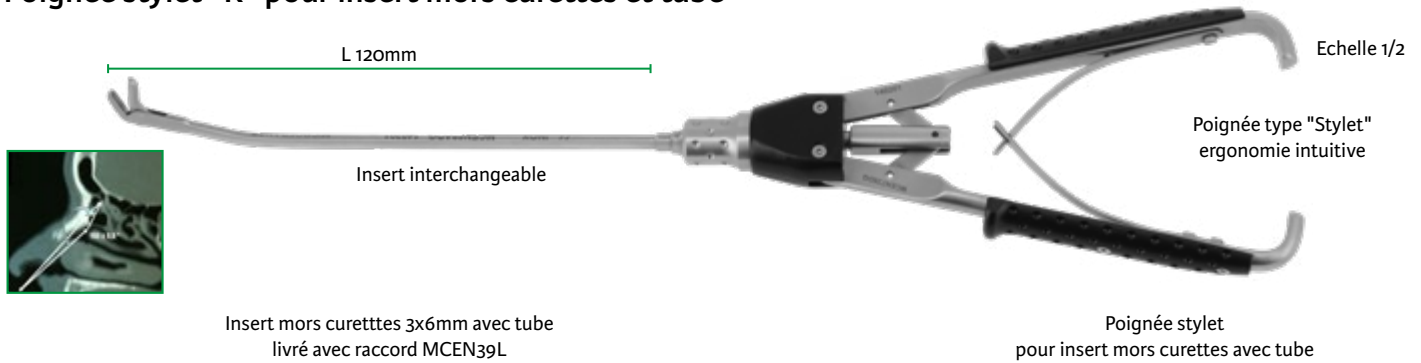

Insert mors curettes 3x6mm avec tube
livré avec raccord MCEN39L

Poignée stylet
pour insert mors curettes avec tube



MCEN68CDG
tube droit



MCEN68BDG
tube extrémité coudée

MCEN68ADG
Insert 45°
tube extrémité coudée

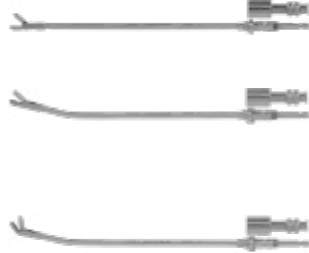

Echelle 1/4

MCEN728DG



MCEN39L

Echelle 1/2

Raccord luer-lock pour lavage insert-tube - Pack 3

Echelle 2/3

Longueur utile «L»

Jankowski

Mors curettes ajourées

droite 45° 90°



mors 3x8mm

MCEN62T1 MCEN62A1 MCEN62B1



mors 5x11mm

MCEN62T2 MCEN62A2 MCEN62B2



mors 6x11mm

MCEN62T3 MCEN62A3 MCEN62B3



90°

mors 4x17mm

7762A4



L 100mm

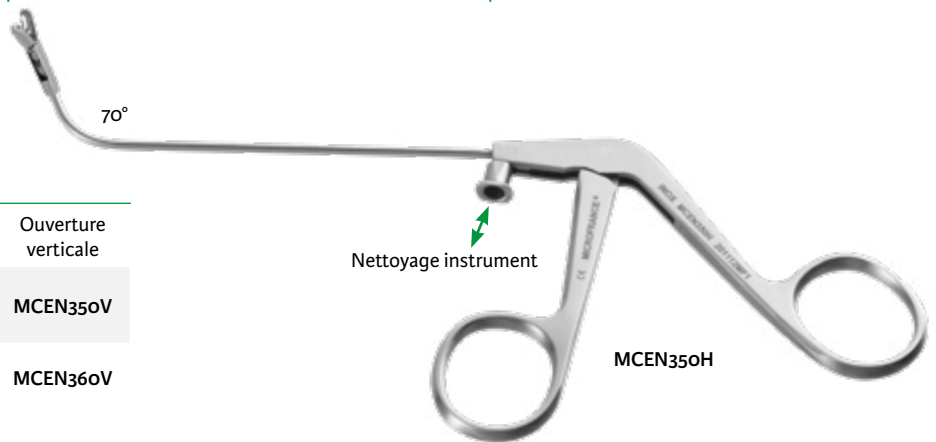

70°

Nettoyage instrument

MCEN350H

Pince courbe en haut mors curettes 2x4mm



Courbure	Ouverture horizontale	Ouverture verticale
70°	MCEN350H	MCEN350V
100°	MCEN360H	MCEN360V

L 90mm

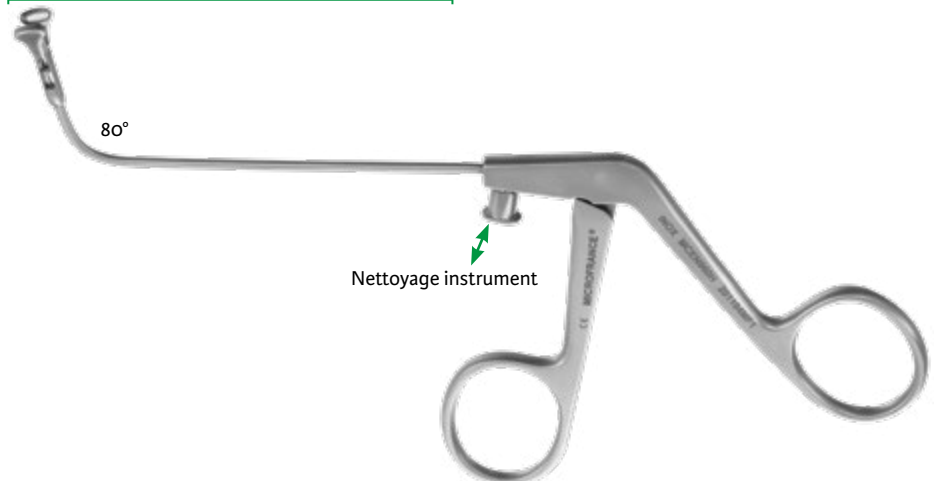

80°

Nettoyage instrument

Pince courbe en haut mors curettes forme poire



MCEN960H

courbure 80°

Rouvier



MCEN4
3x6mm



MCEN5
3x6mm



MCEN5B
3x12mm



MCEN43
cotonnette
1x4mm
30°



MCEN3
2mm

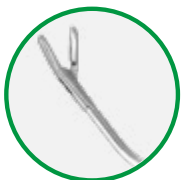

MCEN29
2x5mm
45°
ouverture verticale
à droite

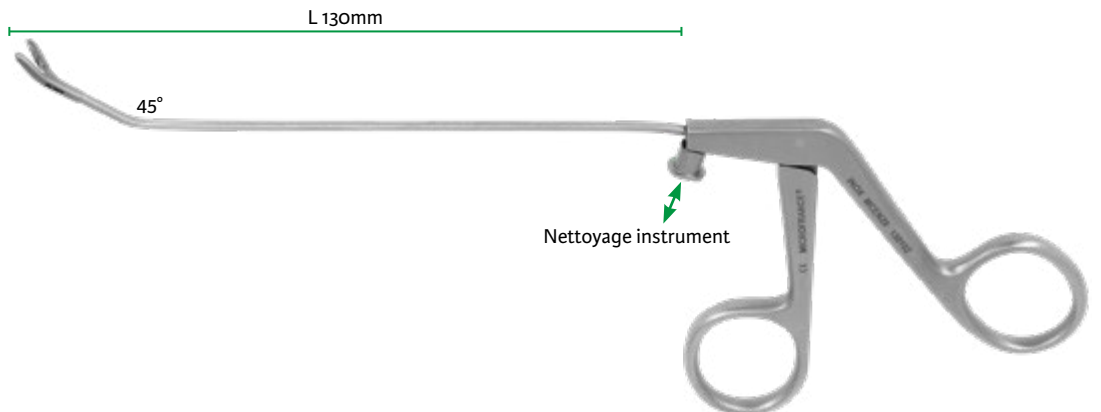
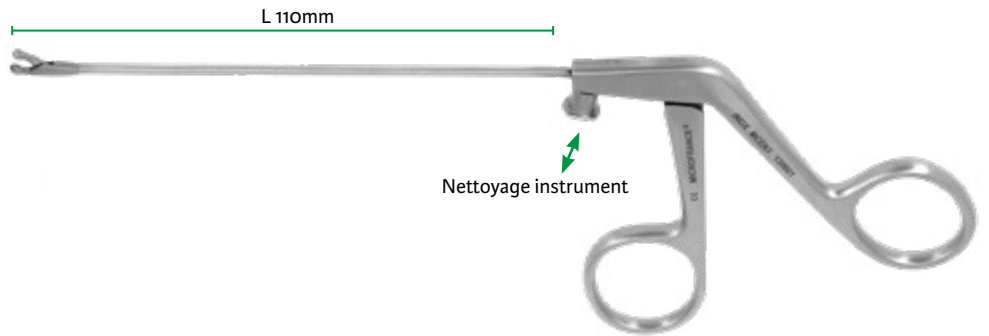
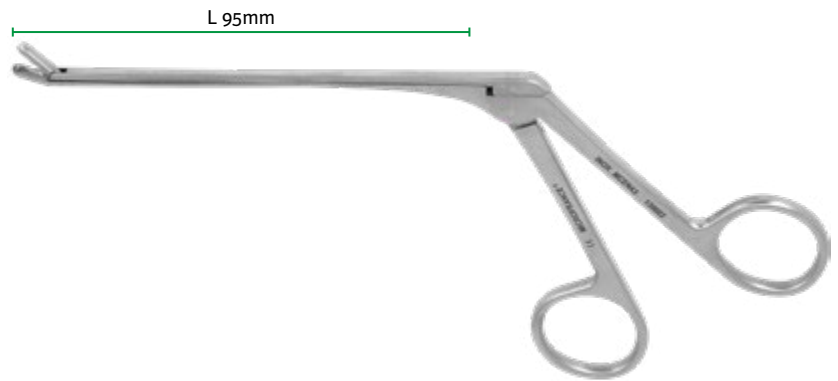
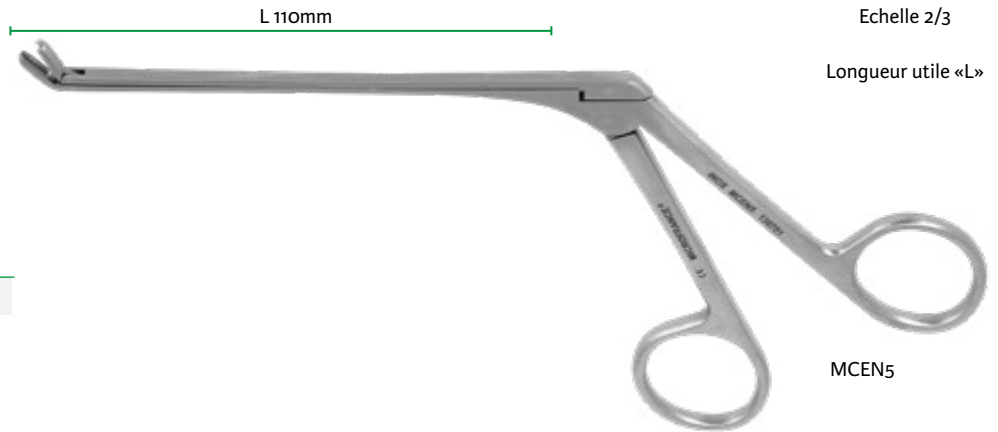

Mors curettes ajourées

Weil-Blakesley

Blakesley

droite

45°

90°



7762-1

7762A-1

7762B-1

mors 3mm

Weil-Blakesley



7762-2

7762A-2

mors 3,5mm

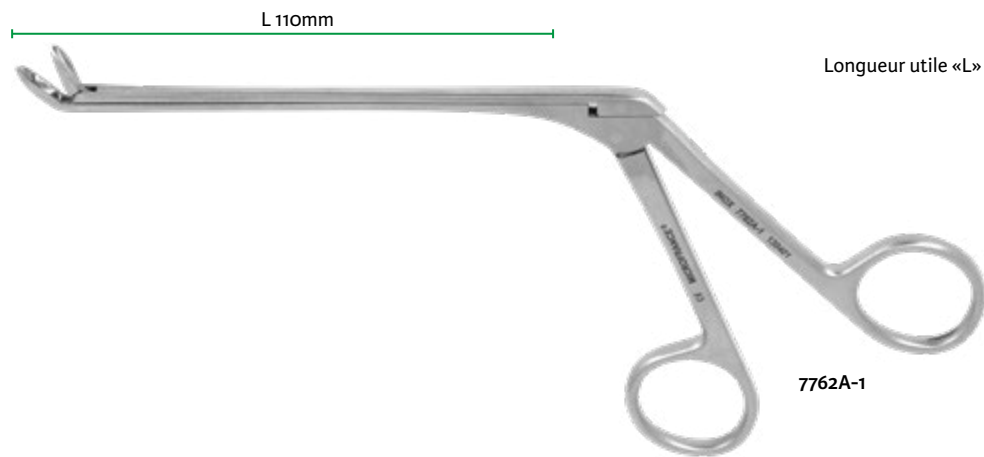

Echelle 2/3

Longueur utile «L»

Mors curettes ajourées
mors 2mm

droit

45°



7763

7763-1

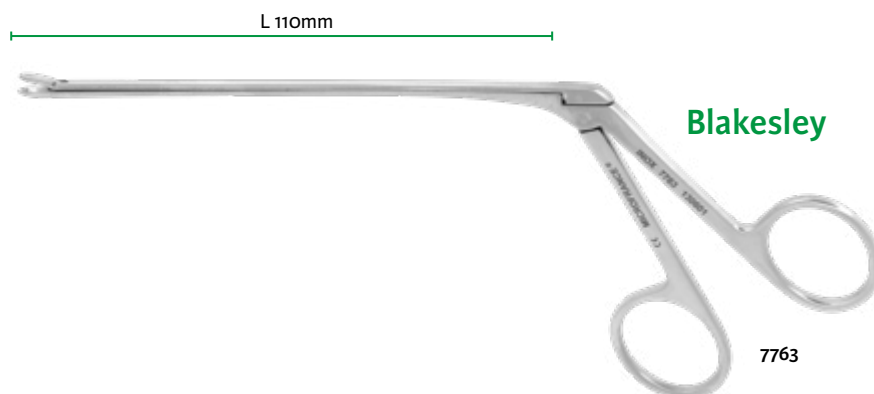

Pince courbe en haut
mors curettes ajourées forme poire 4mm



MCEN96

MCEN97

courbe en haut à 45°
à droite à gauche

L 95mm

Echelle 2/3

Longueur utile «L»

Nettoyage instrument

MCEN96

Pince courbe en haut
mors curettes 2x4mm
ouverture horizontale

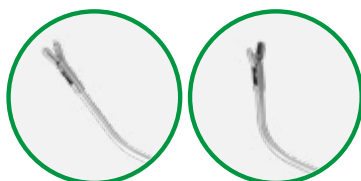

MCEN35

MCEN36

courbe à 45° courbe à 80°

L 120mm

Nettoyage instrument

MCEN35

L 160mm

Peynègre-Bossard

Nettoyage instrument

Pince courbe en "S"
mors curettes ajourée

MCEN53

mors 2x4mm

L 140mm

Peynègre

Nettoyage instrument

Pince courbe en "S"
mors curettes ajourée

MCEN99

mors 3x4mm

Echelle 2/3

Longueur utile «L»

Orsel



Mors curettes 3x4,5mm

MCEN68

courbe à 130°

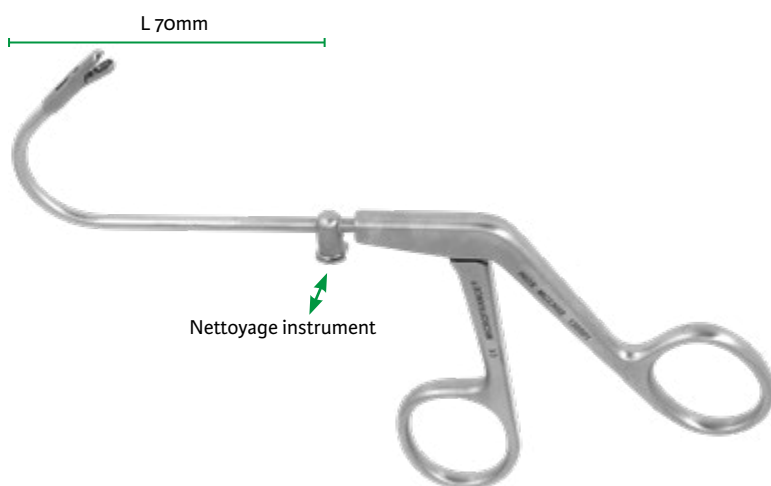

L 70mm

Nettoyage instrument

Terrier

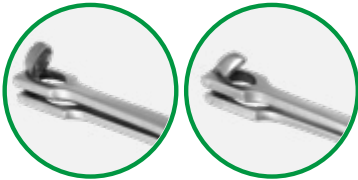

MCEN27-1

3x6mm
L 100mm

MCEN27

4x7mm
L 120mm

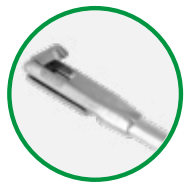
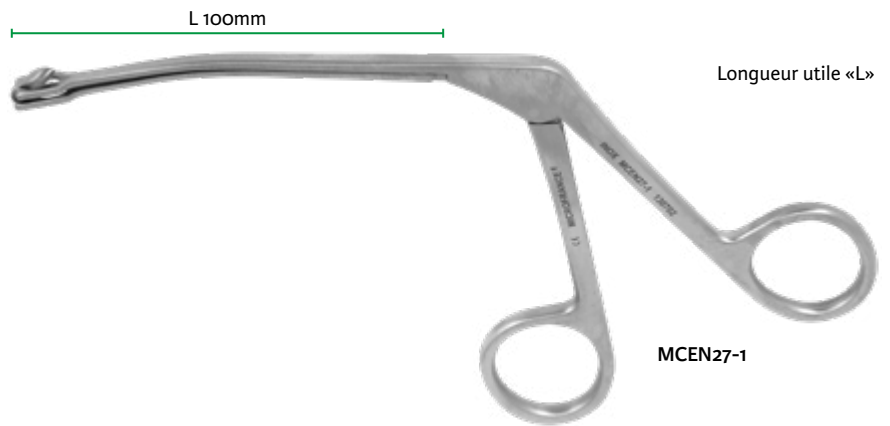

Rotative 360°

MCEN27R

2,5x7mm

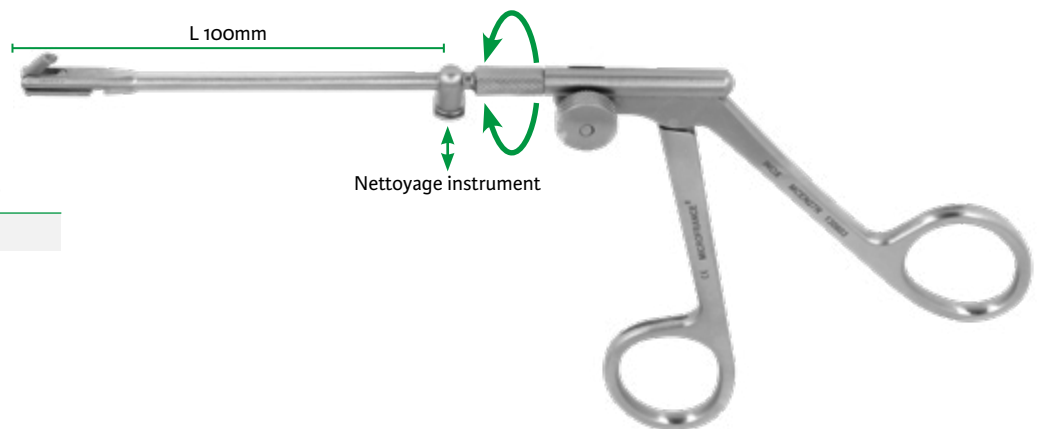

Terrier

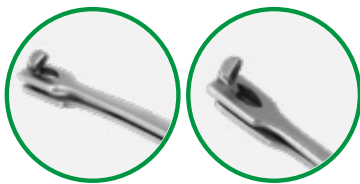

mors 2x4mm

MCEN27-2	MCEN27-3
courbe en bas	courbe en haut

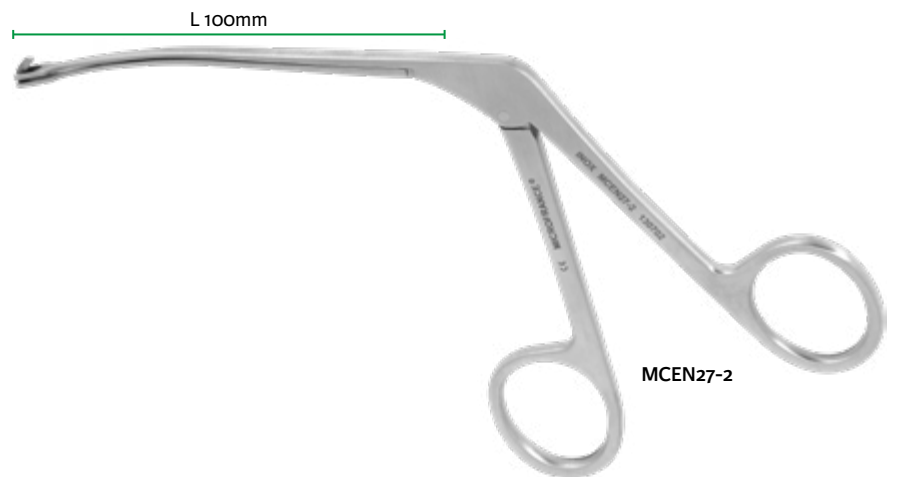

MCEN27-2

Terrier



"Joséphine"
MCEN38
Ouverture à gauche

Rouvier

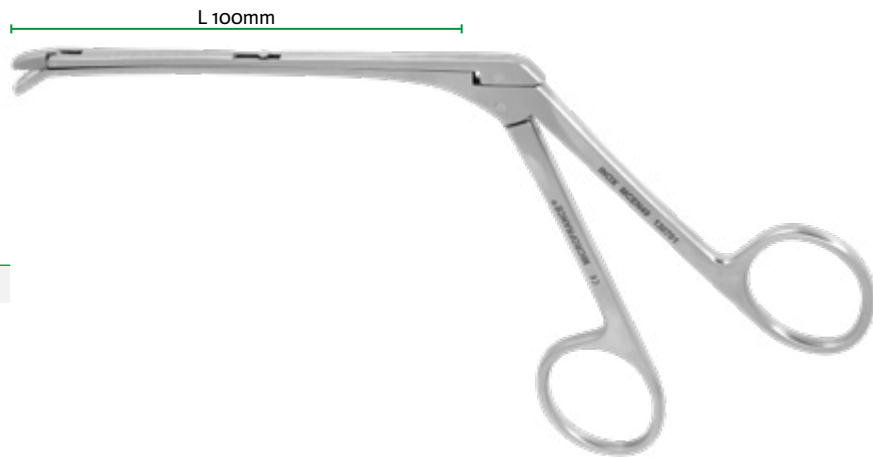

antérograde
MCEN49
mors 4mm - 30°

Longueur utile «L»

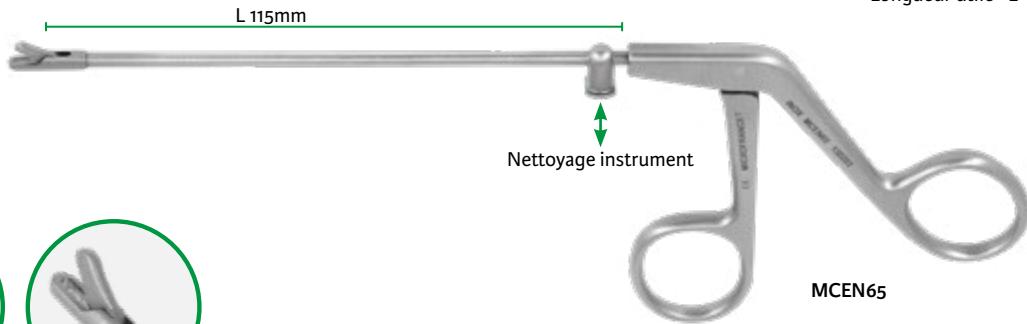

Struycken

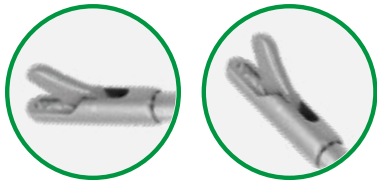

MCEN65	MCEN66
1,5mm droite	1,5mm courbe en haut à 45°

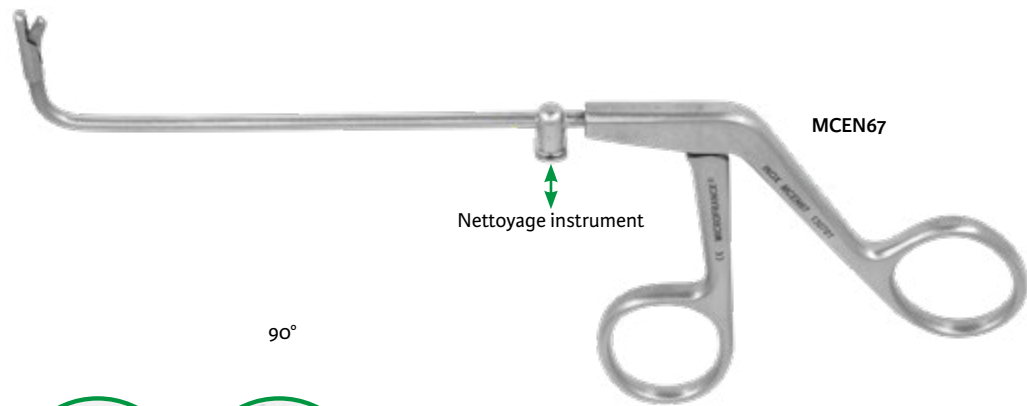

Struycken

90°



L 115mm

MCEN67	MCEN67-1	MCEN67-2
1,5mm	Mors à droite	Mors à gauche

Citelli-Peynègre

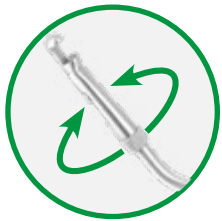

MCEN98
3mm

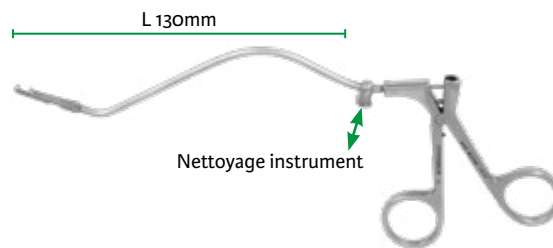

Longueur utile «L»

Citelli-Frèche



MCEN12
4mm - 45°

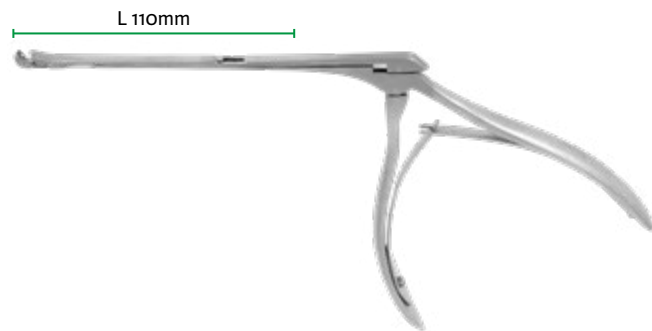

Echelle 1/2

Jankowski

Lames crantées en titane 15mm



MCEN41J

Droit

MCEN42J

Courbe à gauche

MCEN42J1

Courbe à droite

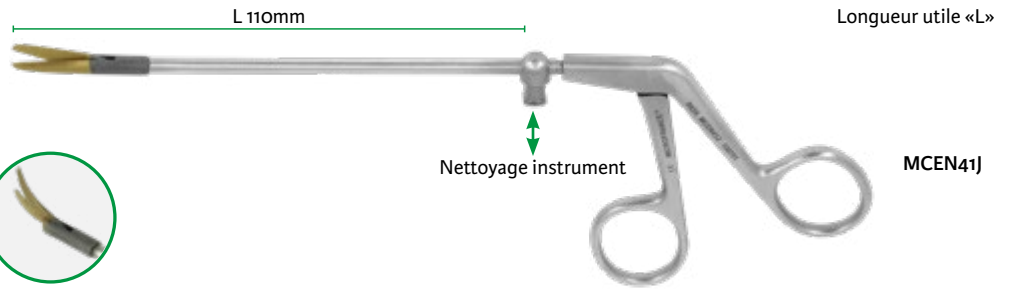

MCEN41J

Dessi

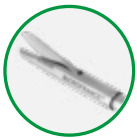

MCEN41D3

lames crantées 10mm

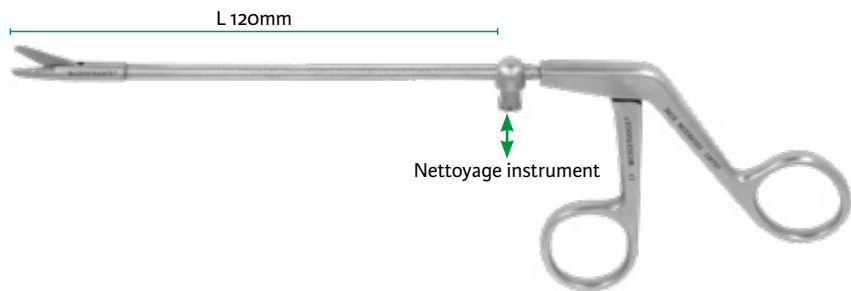

Peynègre

Rouvier



Lames crantées 10mm

MCEN41-1

Droit

MCEN42

Courbe à gauche

MCEN42-1

Courbe à droite

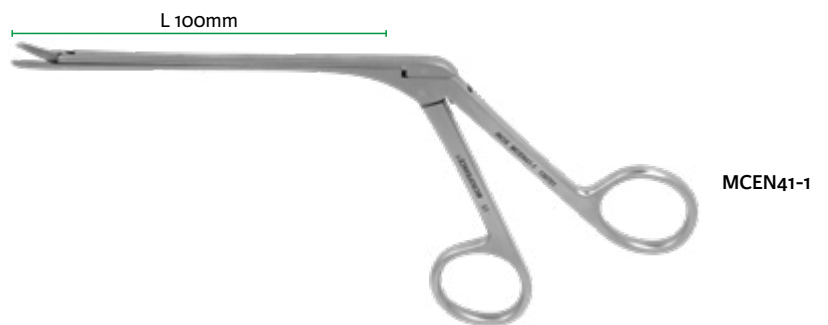

MCEN41-1

Echelle 1/2

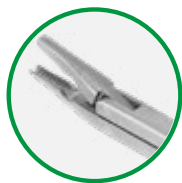

MCEN21
Clip LT200

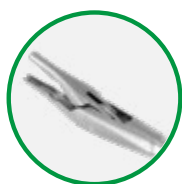

MCEN21R
Clip LT200

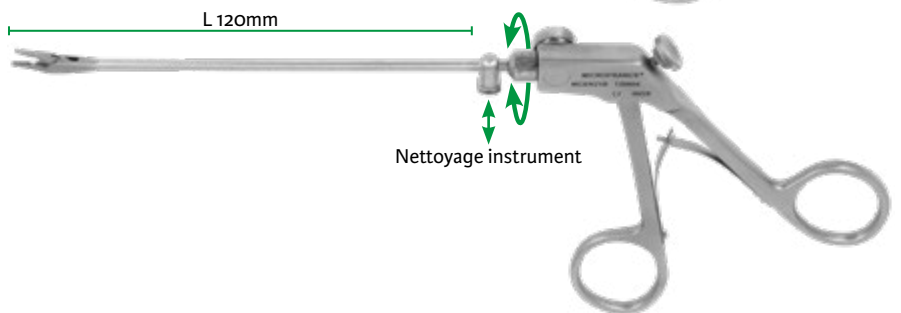
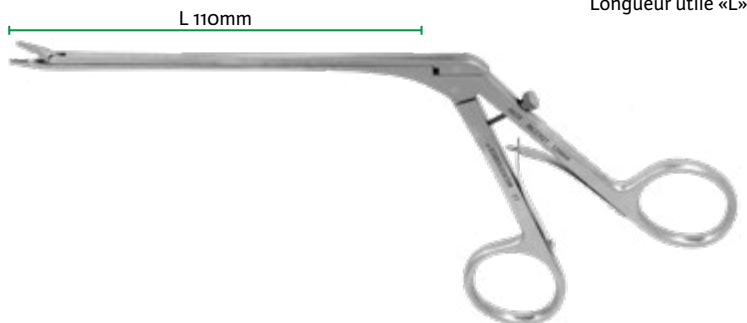

Wormald



MCEN211
Clip LT200

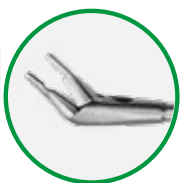

MCEN211S
Clip LT100

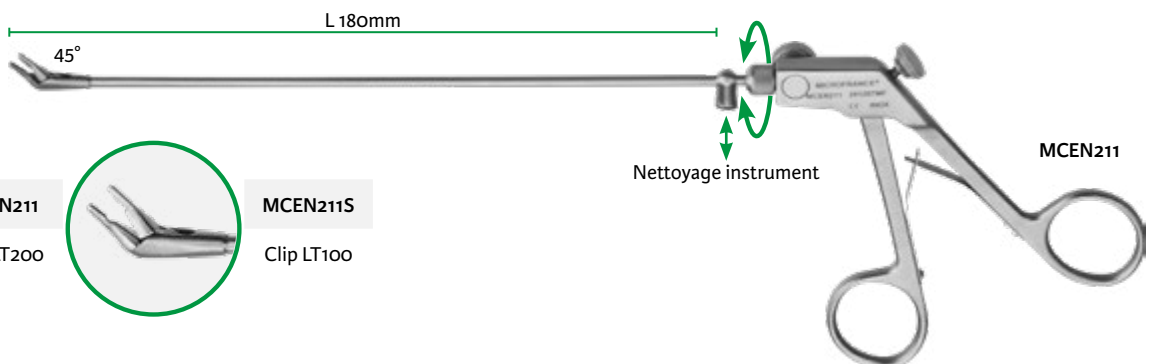

Wormald

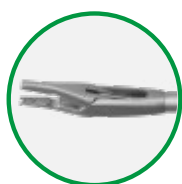

MCEN212
Clip LT200

MCEN212S
Clip LT100

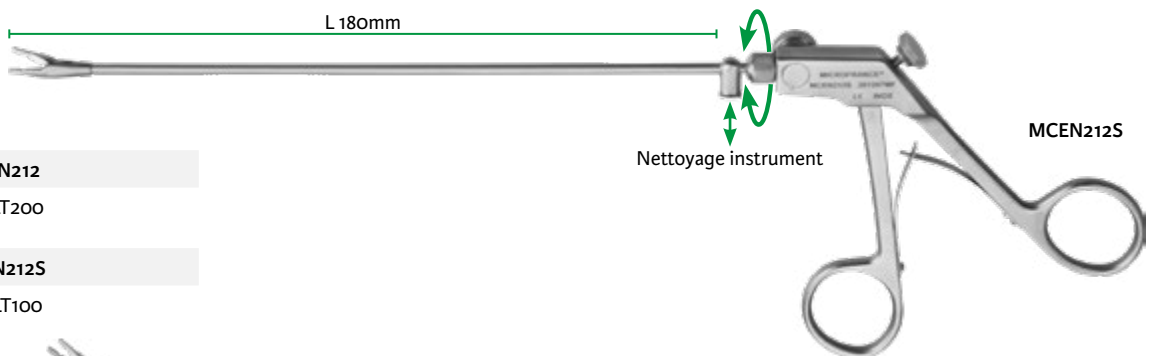

Wormald

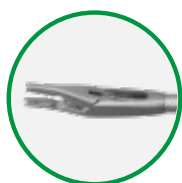

MCEN213
Clip LT200

MCEN213S
Clip LT100

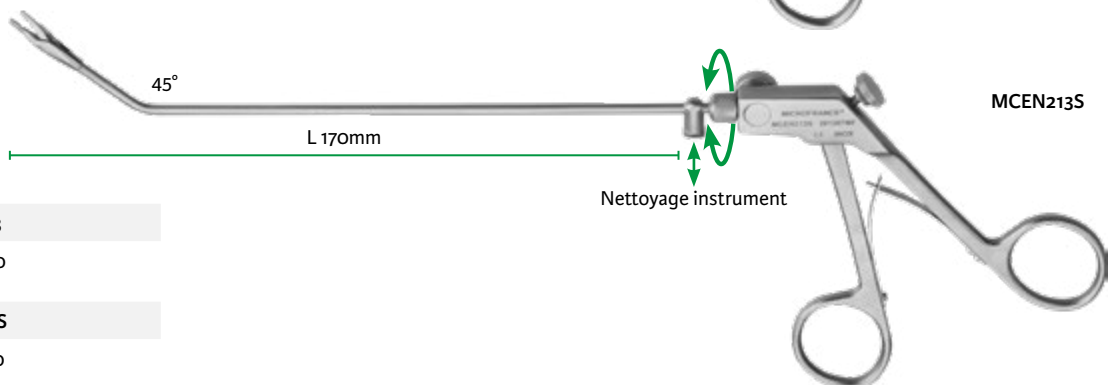

Micro pince bipolaire non démontable

Echelle 2/3

Dessi

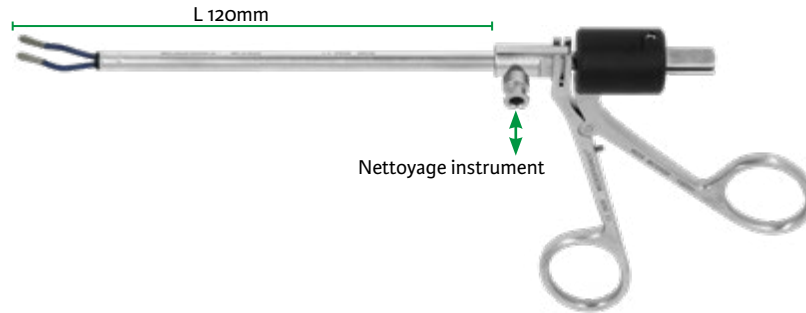

Longueur utile «L»

MCEN54

Micro pince bipolaire démontable

Dessi

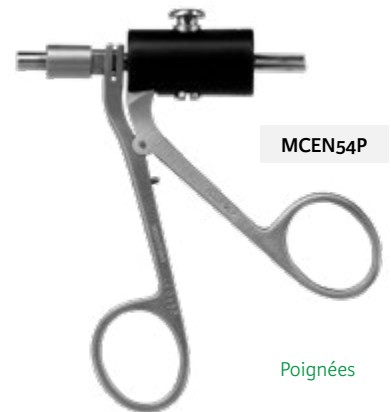
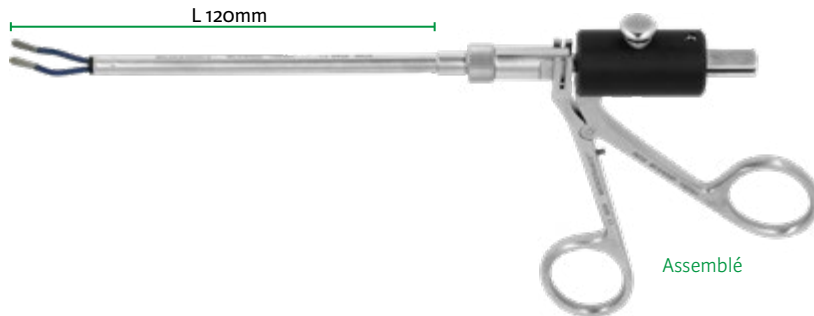

MCEN54G



Tube

MCEN54I



Insert

MCEN54H



Herman
Insert

CEV669BG



Câbles bipolaires - 4.5 m

<p>CP393-2 Bowa Emc Lamidey Valleylab</p>	
<p>CP393-3 Erbe VIO ICC ACC (sauf international) Storz Wolf</p>	
<p>CP393-4 Aesculap Berchtold Martin Sutter BM-780 II</p>	

Echelle 1/2

Longueur utile «L»

Wormald

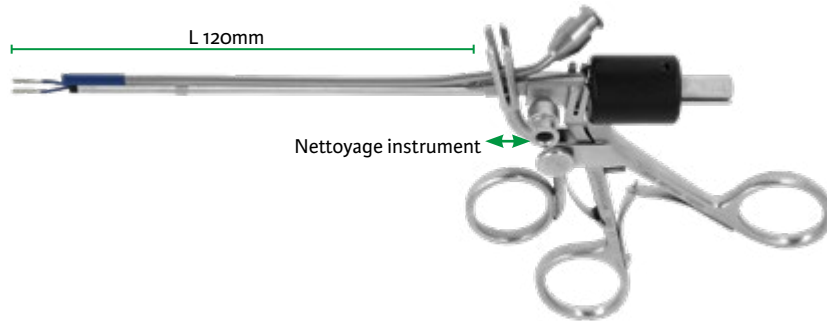
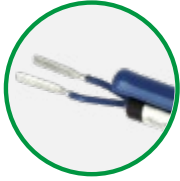

MCEN64

Wormald

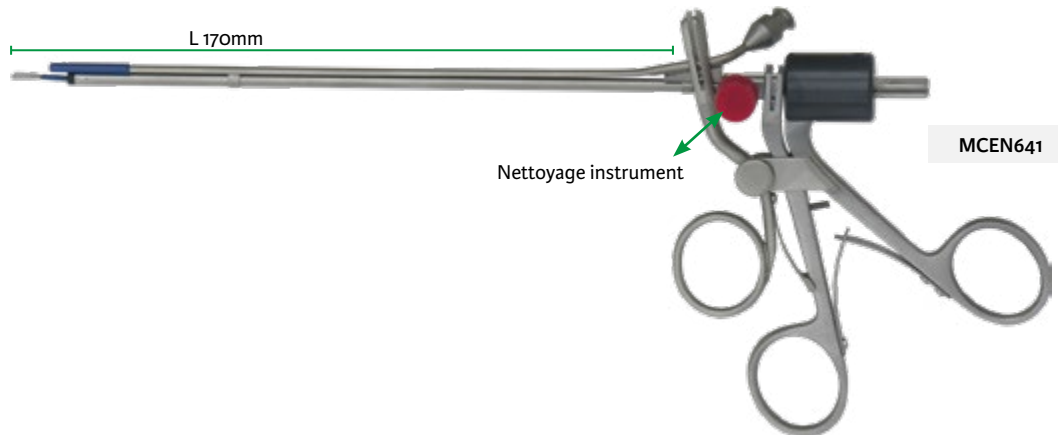
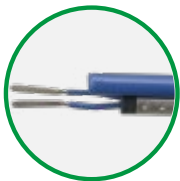

MCEN641

Wormald

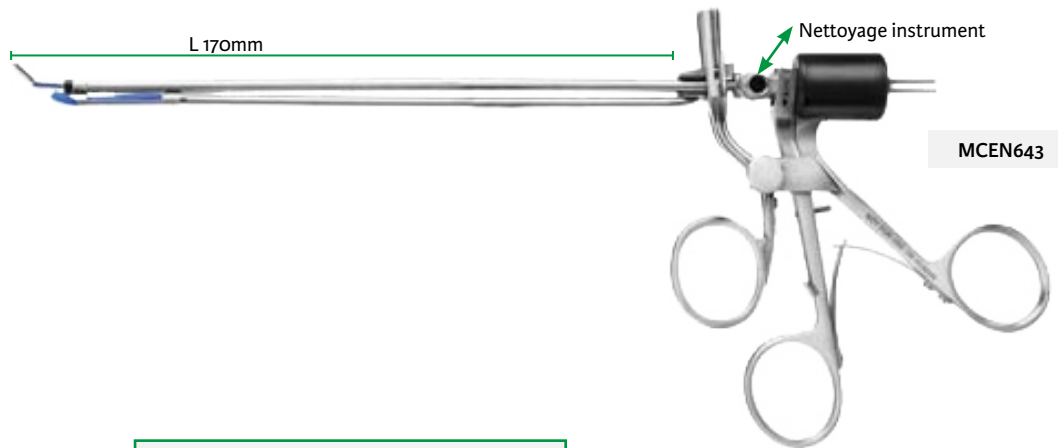

MCEN643

Câbles bipolaires - 4.5 m

CP393-2 Bowa Emc Lamidey Valleylab	
CP393-3 Erbe VIO ICC ACC (sauf international) Storz Wolf	
CP393-4 Aesculap Berchtold Martin Sutter BM-780 II	

Crochet

Longueur utile «L»

Echelle 1/2

Frèche



90°

L 70mm



200mm

MCEN101

Herman



90° - 5mm

L 125mm



245mm

MCEN128

Décolleur aspirateur

Appelbaum



Ø2mm

L 65mm

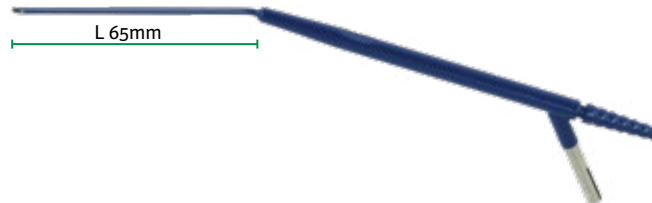

170mm

MCEN730

Aspirateur à soupape

Frèche

MCEN100-2-0	2mm
MCEN100-2-5	2,5mm
MCEN100-3-0	3mm
MCEN100-3-5	3,5mm

L 145mm



200mm

MCEN100-2-5

Bistouri lancéolé

Frèche



L 140mm

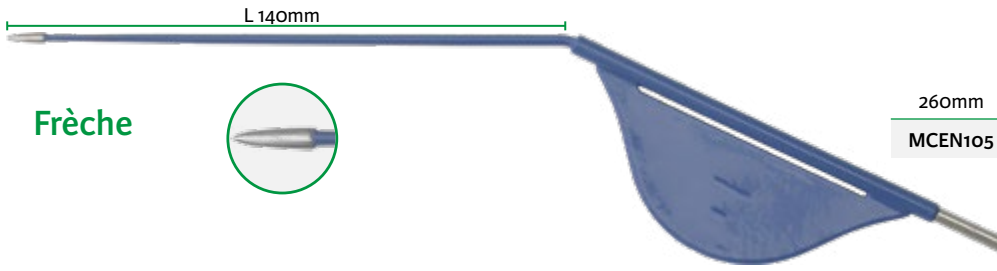

260mm

MCEN105

Pointes

Rouvier



L 110mm

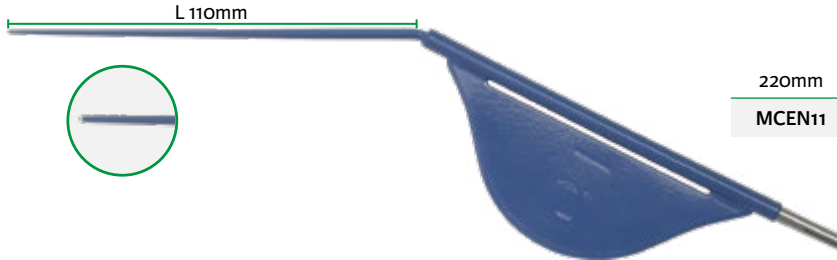

220mm

MCEN11

Rouvier



L 110mm

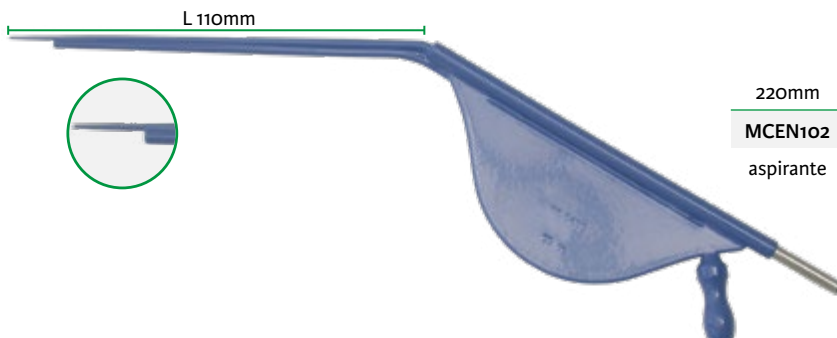

220mm

MCEN102
aspirante

Câbles monopolaires - 3,5 m



CP391E

Erbe ACC ICC/VIO Storz Wolf



CP391M

Aesculap Berchtold Martin Erbe T Serie
Lamidey Sutter BM-780 II



CP391V

Bowa Bovie Conmed Valleylab

Fraise forêt à butée variable



Echelle 1/1

7777

85mm

Ø 2mm

Chignole à manivelle



7776^(D)

livré avec clé

^(D) Distribué par Integra MicroFrance SAS (France) - Voir tableau d'équivalence annexe pour la référence du fabricant correspondante

Longueur utile «L»

Clous

Lemoine



7778

L 15mm



7778-1

L 10mm

Echelle 1/1

Klossek



7778K

L 15mm



7778K1

L 10mm

Instrumentation de Kennedy - 150mm

Kennedy

Longueur utile «L»

Echelle 1/1

L 105mm

Malléable



Palpateur

MCSK1



Crochet pointu

MCSK2



Crochet mousse - 90°

MCSK3



Crochet mousse - 150°

MCSK4



Curette - 1mm

MCSK5



Aspirateur - 2mm

MCSK5

Bistouri aspirateur à soupe

Echelle 1/2

Longueur utile «L»

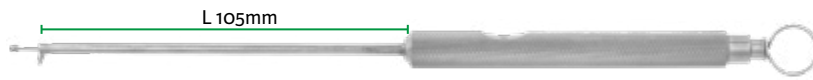

MCEN111
205mm



MCEN111 4mm - 80°	MCEN112 4mm - 90°	MCEN120 4mm - 135°
-----------------------------	-----------------------------	------------------------------

Pince mors curettes avec aspiration

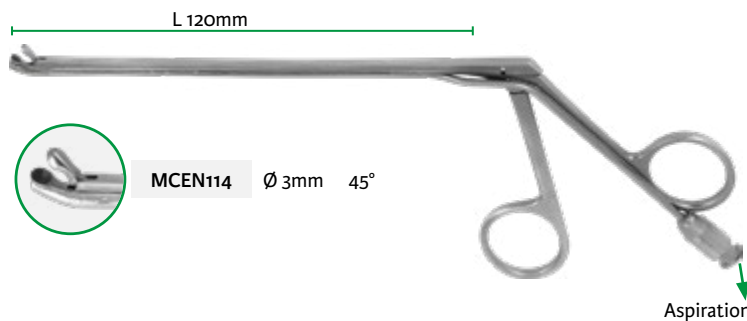

Aspirateur à soupe 170mm

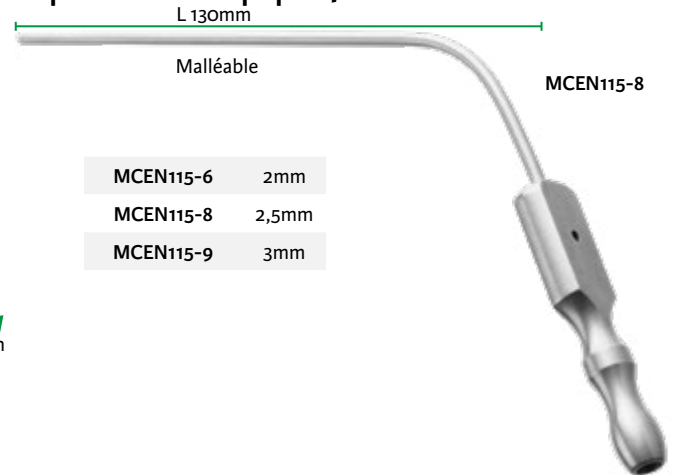

Nettoyeur



Pince punch emporte-pièce avec aspiration

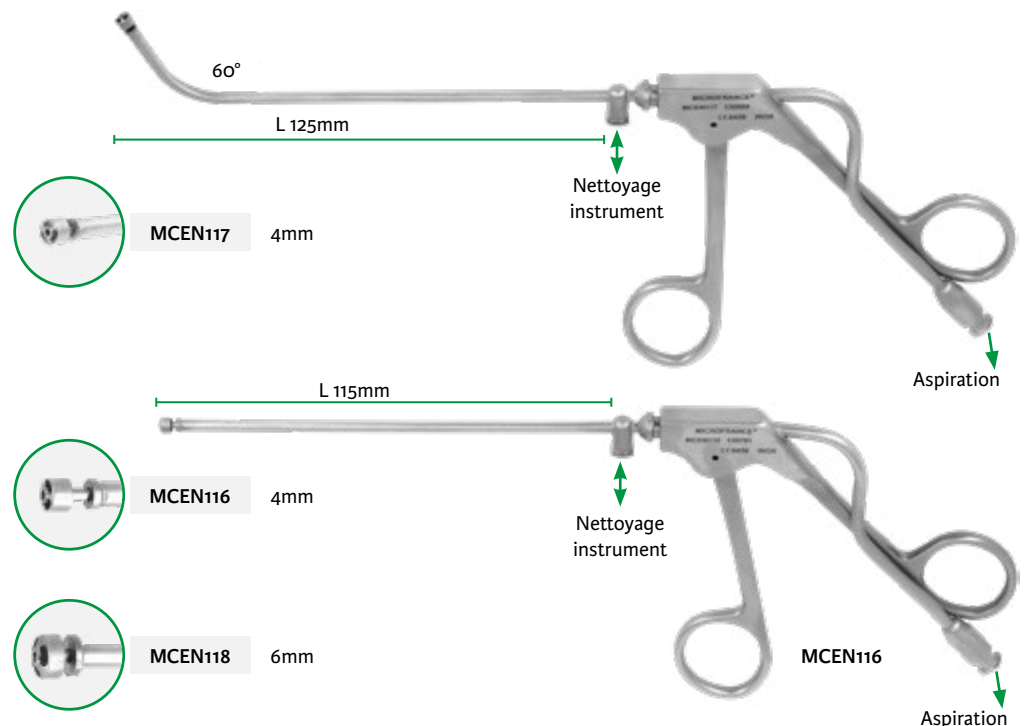

Echelle 2/3

Micro curette aspirateur à soupape

Longueur utile «L»

150mm - Ø 3,5mm

MCEN768 Curette 90°

MCEN769 Curette 60°



Bistouri double

190mm

MCEN720



240mm

MCEN760



240mm

MCEN761



Micro palpateur double

195mm

MCEN721



190mm

MCEN723



245mm

MCEN762



245mm

MCEN763



Micro palpateur coudé



MCEN155 180mm

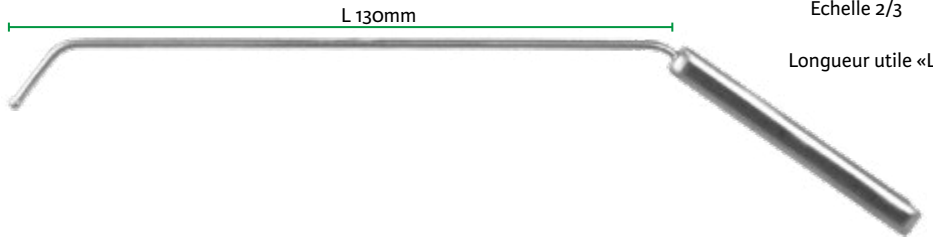

Echelle 2/3
Longueur utile «L»

Décolleur coudé



MCEN157 180mm

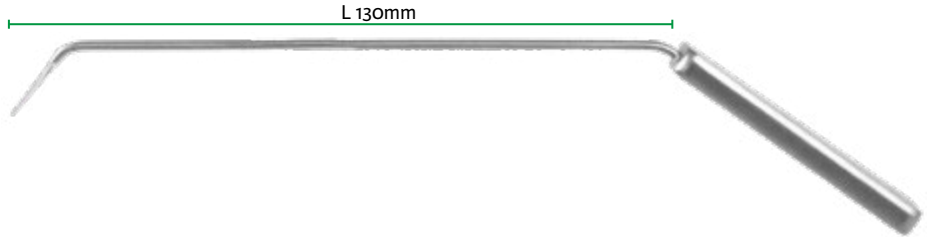

Aspirateur boutoné



MCEN156 185mm
Ø 2mm

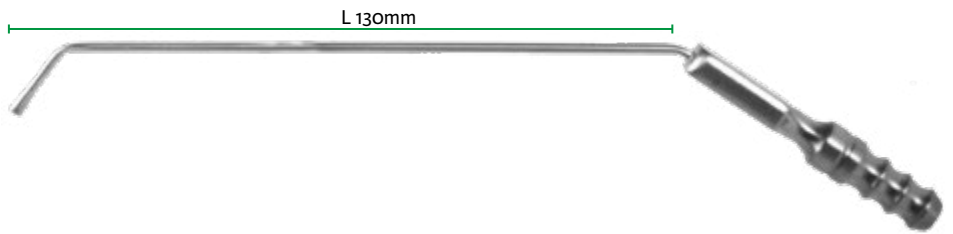

Décolleur aspirateur



MCEN158 185mm
Ø 2mm

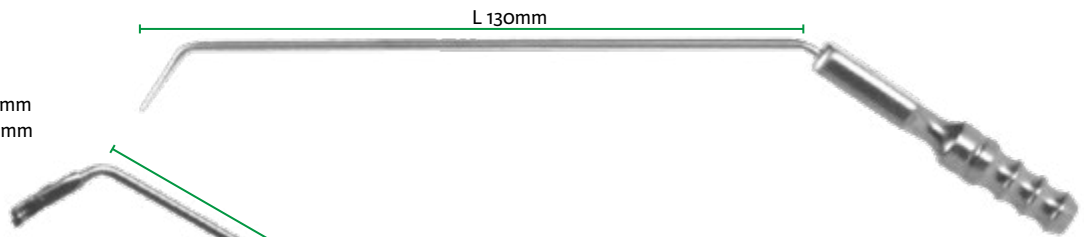

Pince mors curettes

courbe en bas



MCEN151

Ouverture verticale



MCEN152

Ouverture horizontale

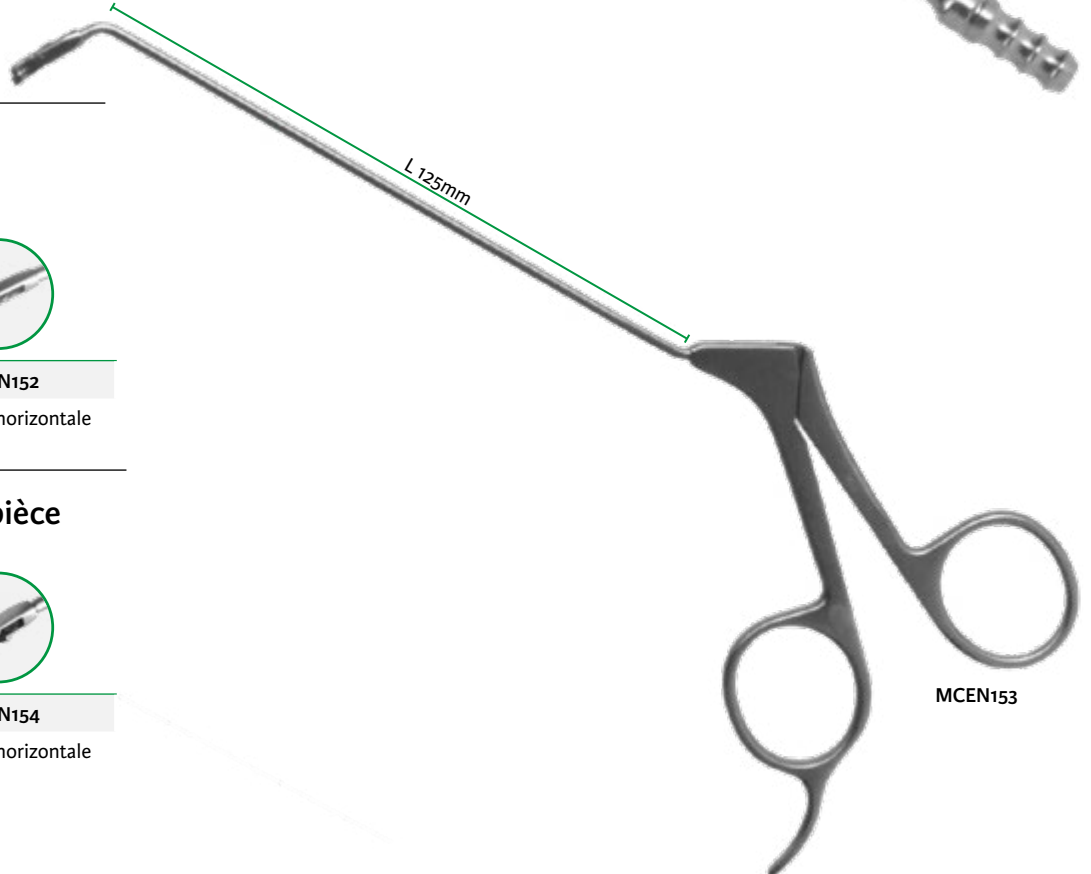

MCEN153

Pince punch emporte-pièce



MCEN153

Ouverture verticale



MCEN154

Ouverture horizontale

Echelle 2/3

Longueur utile «L»

Anneau mousse, bistouri, micro curette aspirateur à soupape

L 105mm

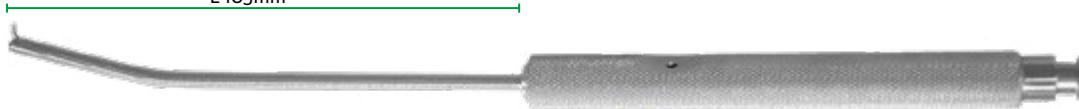

210mm
MCEN165



Anneau mousse



Bistouri aspirateur à soupape

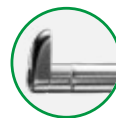

Micro curette aspirateur à soupape

MCEN161	MCEN163	MCEN164	MCEN165	MCEN167
135° - Ø 3mm	90° - Ø 3mm	135° - Ø 3mm	45° - Ø 3mm	90° - Ø 3mm

Micro bistouri, bistouri falciforme, anneau mousse tige courbe

L 120mm



MCEN168

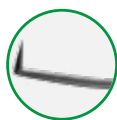

Micro bistouri
90°



Bistouri falciforme
Courbe



Anneau mousse
70°

MCEN162	MCEN168	MCEN170
180mm	225mm	250mm

Micro instrument double palpeur - perforateur

Perforateur



250mm

MCEN171

Micro palpeur

Pince mors striés

L 115mm



Pince mors striés

MCEN169

3x12mm

Micro palpeur, aspirateur à soupape, décolleur aspirateur, anneau mousse

Echelle 2/3

Longueur utile «L»

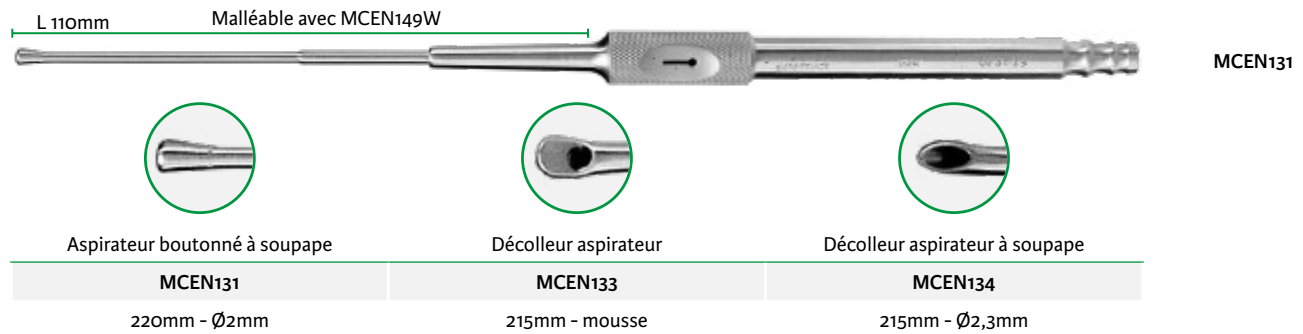
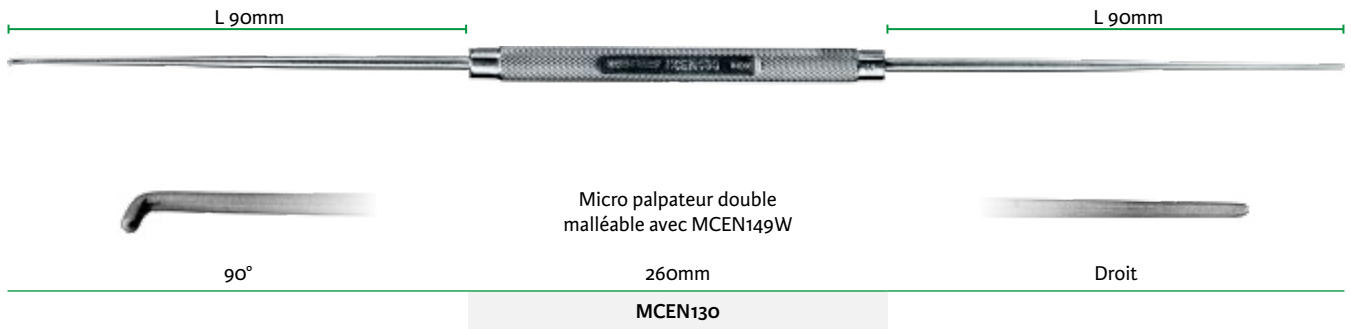

Pousse-noeud



Echelle 1/2

Micro Palpateur, aspirateur à soupape, micro curette, micro aspirateur, décolleur aspirateur

Longueur utile «L»

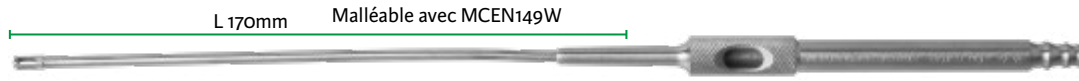

MCEN142

Aspirateur à soupape

Micro curette aspirateur à soupape

Micro aspirateur à panier et soupape

Décolleur aspirateur



MCEN138	MCEN138S	MCEN140	MCEN140A	MCEN141	MCEN141A	MCEN142	MCEN147
Ø 3,5mm	Ø 2mm	Ø 2,5mm 45° 4x5mm	Ø 2,5mm 45° 5x6mm	Ø 2,5mm 90° 4x5mm	Ø 2,5mm 90° 5x6mm	Ø 2,5mm	Ø 2,5mm



MCEN139A

Micro palpateur



MCEN139	MCEN139A
90°	droit



Instrument de cambrage
MCEN149W
150mm

Micro ciseaux, micro pinces, container

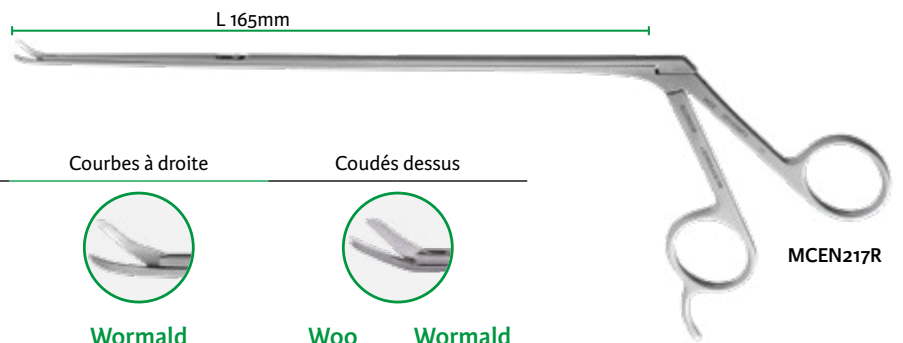

MCEN217R

Ciseaux

Droits

Courbes à gauche

Courbes à droite

Coudés dessus

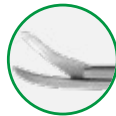
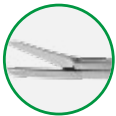

Woo	Wormald	Wormald	Wormald	Woo	Wormald
MCLW10	MCEN217S	MCEN216L	MCEN217L	MCEN216R	MCEN217R
5mm	8mm	5mm	8mm	5mm	8mm
MCLW11	MCEN217U				
5mm	8mm				

Pince mors curettes fenêtrées 230mm



MCEN214	MCEN215
mors droits 1,5x3,5mm	mors 45° 1,5x3,5mm

Porte-aiguille tungstène

Echelle 1/2

Longueur utile «L»



MCEN218
tungstène

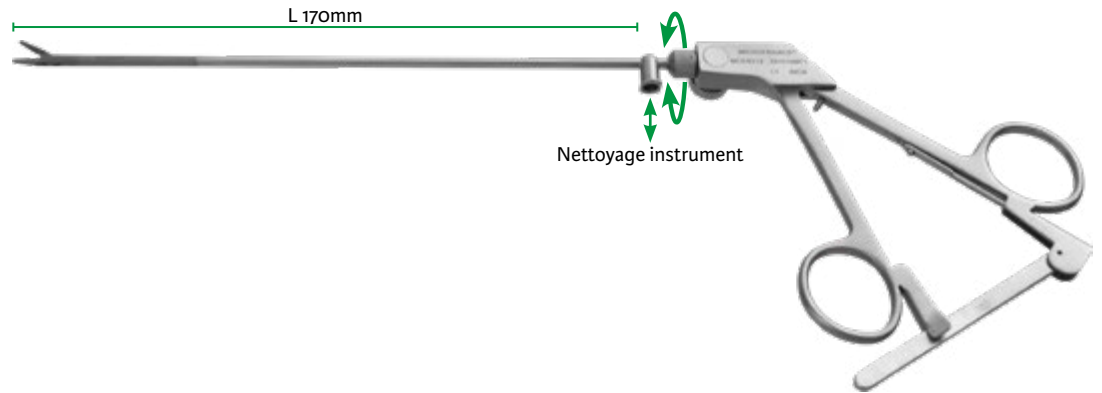

Clamp vasculaire

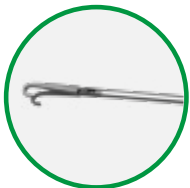

MCEN191



MCEN192

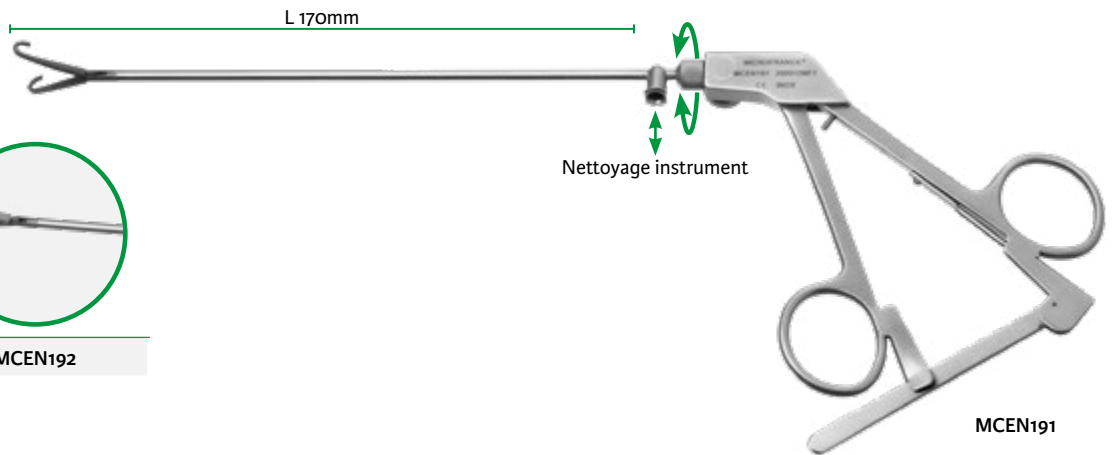

MCEN190



MCEN193

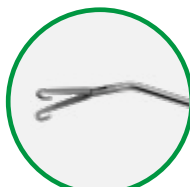

MCEN194

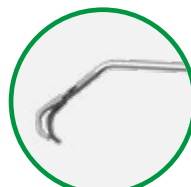

MCEN195

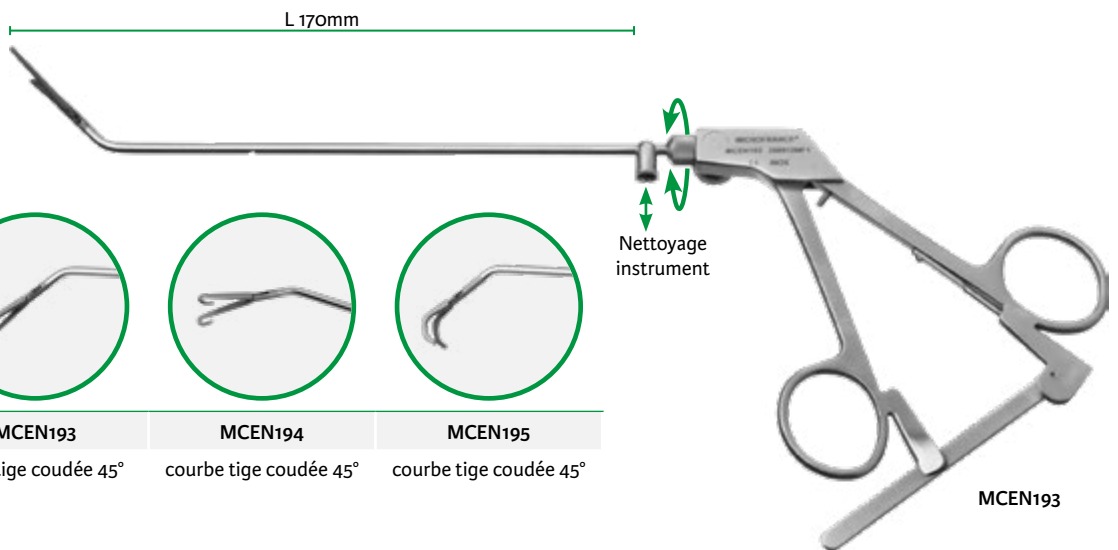

Droit tige coudée 20°

Droit tige coudée 45°

courbe tige coudée 45°

courbe tige coudée 45°

Echelle 1/2

Longueur utile «L»

Aspirateur boutoné à soupape



210mm
MCEN349



MCEN347	MCEN348	MCEN349
Ø 2mm	Ø 1,5mm	Ø 2mm

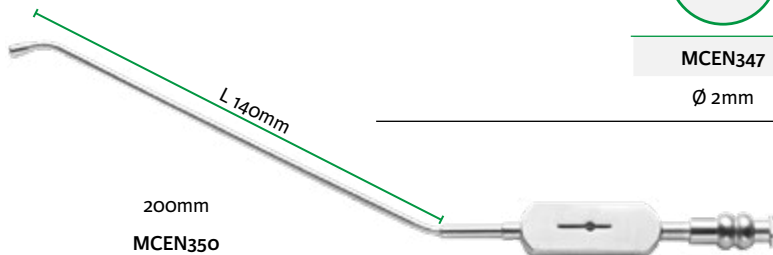

Aspirateur boutoné coudé

MCEN350	MCEN351
Coudée vers le bas Ø 2mm	Coudée vers le haut Ø 2mm

Micro crochet, dissecteur boule, micro décolleur



230mm
MCEN345

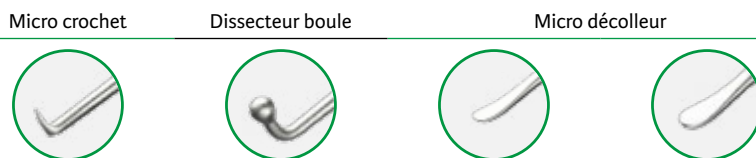

MCEN329	MCEN330	MCEN345	MCEN346
Ø 1,5mm	Ø 3mm	Ø 2mm	Ø 4mm

Pince mors culettes baïonnette, ciseaux, pince bipolaire

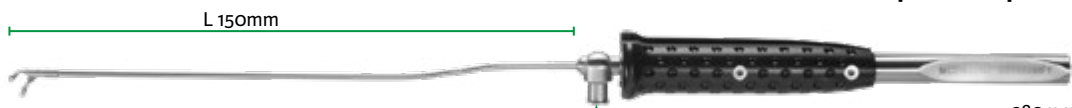

280mm
MCEN328U

Pince mors culettes baïonnette



MCEN328S
Droite Ø 2,5mm



MCEN328U
Coudées dessus Ø 2,5mm

Nettoyage instrument

Ciseaux



MCEN344S
5mm - Droit



MCEN344U
5mm - 45°



MCEN344V
5mm - Courbe

Nettoyage instrument

280mm
MCEN344U

Pince bipolaire



MCEN364
45° - 1x5mm



MCEN365
Baïonnette

Nettoyage instrument

300mm
MCEN365

Câbles bipolaires - 4,5 m

CP393-2
Bowa Emc
Lamiedy
Valleylab



CP393-3
Erbe VIO ICC
ACC (sauf
international)
Storz Wolf



CP393-4
Aesculap
Berchtold
Martin Sutter
BM-780 II





Echelle 1/2

Cupule

7876-60^(D)	60mm
7876-80^(D)	80mm
7876-100^(D)	100mm
7876-120^(D)	120mm
7876-160^(D)	160mm



Plateau inox

7872-24^(D)	240x180mm
------------------------------	-----------

Echelle 1/4



Spray instruments

MCO731^(D)

Panier

Echelle 1/5



7874MF-22

240x105x45mm
220x100x40mm

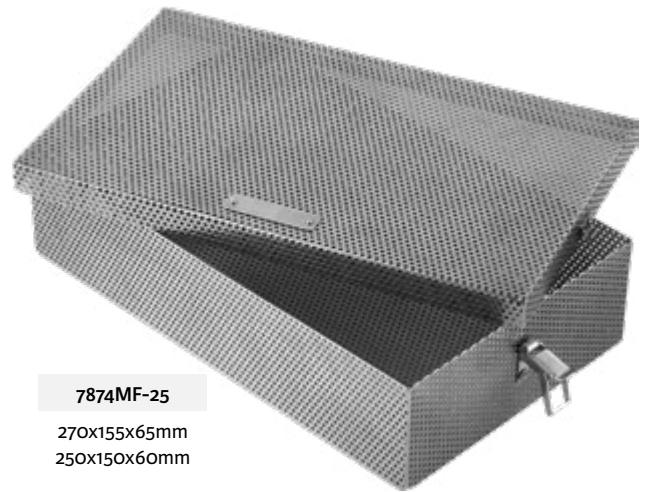

7874MF-25

270x155x65mm
250x150x60mm

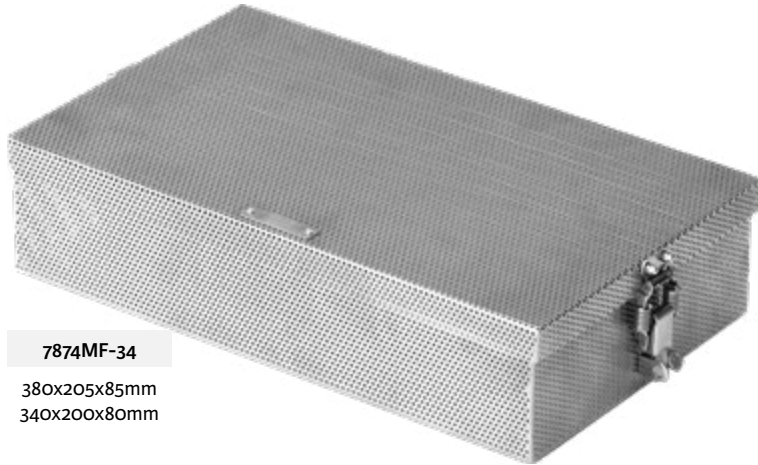

7874MF-34

380x205x85mm
340x200x80mm

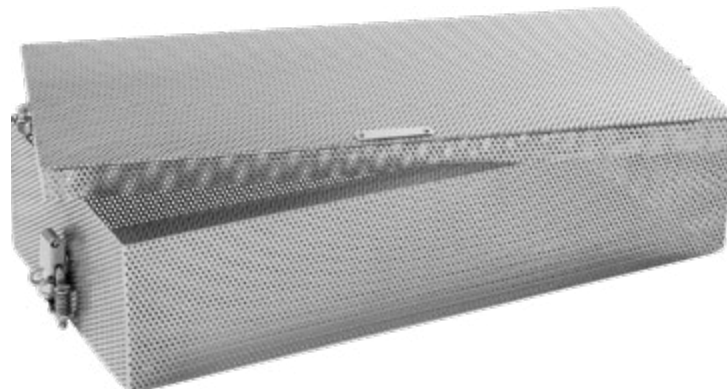

7874MF-40

440x205x95mm - 400x200x90mm

^(D) Distribué par Integra MicroFrance SAS (France) - Voir tableau d'équivalence annexe pour la référence du fabricant correspondante

Index numérique

1

1003IG ^(D)	14
1003LI ^(D)	14
1004IG ^(D)	14
1005I ^(D)	14
1352431.....	77
1375012.....	73
1375020.....	73
1375025.....	73
1375101.....	73
1375102.....	73
1375103.....	73
1375107.....	73
1375110.....	73
1375114.....	73
1375201.....	73
1375207.....	73
1375210.....	73
1375214.....	73

3

3714024.....	19
3714025.....	19
3714026.....	19
3714027.....	20
3714028.....	20
3714055.....	28
3714056.....	28
3714057.....	28
3714058.....	28
3714096.....	33
3714098.....	30
3714099.....	30
3714107.....	19
3714108.....	19
3714109.....	19
3714111.....	19
3714148.....	37
3714149.....	37
3714164.....	15
3714166.....	15
3714182.....	22
3714183.....	22
3714187.....	22
3714320.....	28
3714364.....	19
3714379.....	76
3714678.....	15
3724059.....	16
3724256.....	19

7

7706MF.....	2
7717C.....	2
7719-2.....	3
7722-3.....	2
7726MF.....	7
7727.....	7
7728.....	7
7731.....	3
7732-1.....	7
7733.....	7
7734.....	7
7742-1.....	2
7742-2.....	2
7742-3.....	2
7746A ^(D)	2
7746B ^(D)	2
7749.....	8
7750.....	8
7761-1.....	8
7761-2.....	8
7761B-1.....	8
7761B-2.....	8
7761BC1.....	8
7761BC2.....	8
7761BC3.....	8
7761C1.....	8
7761C2.....	8
7761C3.....	8
7762-1.....	83
7762-2.....	83
7762-5.....	79
7762A-1.....	83
7762A-2.....	83
7762A4.....	81
7762A-5.....	79
7762B-1.....	83
7763.....	84
7763-1.....	84
7764.....	40
7765.....	44
7766.....	26
7768.....	18
7768-1.....	18
7771.....	75
7771B.....	75
7774.....	24
7776 ^(D)	97
7777.....	97
7778.....	97
7778-1.....	97
7778K.....	97

7778K1.....	97
7779MF-1.....	9
7779MF-2.....	9
7779MF-3.....	9
7779MF-5CC.....	9
7782-1-2.....	20
7783-12.....	9
7787-10.....	16
7831A-12.....	55
7831A-15.....	57
7831A-18.....	59
7831A-20.....	61
7832.....	61
7833A-12.....	55
7833A-15.....	57
7833A-18.....	60
7833A-20.....	61
7834.....	61
7866-13.....	68
7867-1.....	65
7867-2.....	65
7867-3.....	65
7867-4.....	65
7872-24 ^(D)	106
7874MF-22.....	106
7874MF-25.....	106
7874MF-34.....	106
7874MF-40.....	106
7876-60 ^(D)	106
7876-80 ^(D)	106
7876-100 ^(D)	106
7876-120 ^(D)	106
7876-160 ^(D)	106
7881.....	2
7882.....	2
7896-1.....	2
7896-2.....	2
7896-3.....	2
7897.....	4
7898.....	4
7899.....	4
7903-50-5 ^(D)	9

A

AQ1728 ^(D)	38
-----------------------------	----

CEV

CEV669BG.....	94
CEV984.....	6
CEV985.....	6

^(D) Distribué par Integra MicroFrance SAS (France) - Voir tableau d'équivalence annexe pour la référence du fabricant correspondante

CP

CP16.....	45	CP305.....	30	CP352-3.....	52
CP16-1.....	45	CP305L.....	30	CP353.....	45
CP17.....	18	CP305R.....	30	CP354.....	46
CP17-1.....	18	CP306.....	22	CP354A.....	46
CP17-2.....	18	CP309-8-12.....	31	CP355.....	47
CP17-3.....	18	CP309-10-14.....	31	CP355A.....	47
CP21-3.....	20	CP309-12-16.....	31	CP355C.....	50
CP21A-3.....	20	CP309-14-16.....	31	CP356.....	45
CP23-4.....	22	CP309-14-18.....	31	CP358.....	45
CP23-6.....	22	CP310.....	17	CP358A.....	45
CP23-8.....	22	CP310D.....	17	CP359.....	53
CP23-10.....	22	CP310E.....	17	CP360.....	54
CP23A-8.....	22	CP313.....	32	CP362.....	46
CP37.....	55	CP313-1.....	32	CP363.....	48
CP291.....	35	CP314-14.....	31	CP365.....	50
CP300.....	27	CP315.....	30	CP367.....	47
CP301-1.....	34	CP315D.....	30	CP367-1.....	47
CP301-2.....	35	CP315G.....	30	CP380.....	41
CP301-3.....	35	CP316.....	30	CP380-1.....	41
CP301-4.....	36	CP317.....	29	CP380-2.....	41
CP301-5.....	36	CP318.....	29	CP380-3.....	41
CP301-9.....	36	CP330-3-0.....	69	CP380-5.....	41
CP301-10.....	36	CP330-4-0.....	69	CP381.....	43
CP302-2.....	25	CP331.....	21	CP390-1.....	63
CP302-3.....	25	CP331-1.....	21	CP390-2.....	63
CP302-4.....	25	CP332.....	55	CP390-8.....	63
CP302-5.....	25	CP333.....	15	CP391E.....	63, 96
CP302-6.....	25	CP335.....	20	CP391M.....	63, 96
CP302-8.....	25	CP337.....	13	CP391V.....	63, 96
CP304-2.....	29	CP337-1.....	13	CP392-1R.....	62
CP304-3.....	29	CP338.....	21	CP392-2R.....	62
CP304-4.....	29	CP339.....	21	CP392-8R.....	62
CP304-5.....	29	CP340.....	21	CP392BI.....	62
CP304-6.....	29	CP341.....	21	CP392BS.....	62
CP304-7.....	29	CP344A.....	17	CP393-2.....	62, 94, 95, 105
CP304-8.....	29	CP344AT.....	17	CP393-3.....	62, 94, 95, 105
CP304-9.....	29	CP344B.....	17	CP393-4.....	62, 94, 95, 105
CP304-10.....	29	CP344BT.....	17	CP400.....	57
CP304-11.....	29	CP344C.....	17	CP400-1.....	55
CP304-12.....	29	CP344CT.....	17	CP400-2.....	60
CP304-14.....	29	CP344D.....	17	CP401.....	58
CP304-15.....	29	CP344DT.....	17	CP406.....	55
CP304-16.....	29	CP344E.....	17	CP407.....	57
CP304B-2.....	29	CP344ET.....	17	CP409.....	59
CP304B-3.....	29	CP345.....	58	CP414.....	55
CP304B-4.....	29	CP348.....	53	CP415.....	57
CP304B-5.....	29	CP350.....	54	CP604.....	56
CP304B-6.....	29	CP351-2.....	51	CP604-15.....	56
CP304B-8.....	29	CP351-3.....	51	CP604BR.....	62
CP304B-10.....	29	CP351-6.....	51	CP604M.....	63
CP304B-12.....	29	CP351-7.....	51	CP605.....	56
		CP352.....	52	CP605-15.....	56
		CP352-1.....	52	CP605BR.....	62
		CP352-2.....	52	CP605M.....	63

^(D) Distribué par Integra MicroFrance SAS (France) - Voir tableau d'équivalence annexe pour la référence du fabricant correspondante

CP606.....	56	CP922.....	48	MCEN12.....	91
CP606-15.....	56	CP922A.....	48	MCEN18.....	8
CP606A.....	56	CP922B.....	49	MCEN19.....	8
CP609.....	20	CP931.....	51	MCEN21.....	93
CP611.....	10	CP931-1.....	51	MCEN21R.....	93
CP612.....	53	CP933-14.....	57	MCEN23-2-5.....	70
CP613.....	53	CP933-16.....	58	MCEN23-3-0.....	70
CP614.....	53	CP933-18.....	60	MCEN25-4-0.....	75
CP615-1.....	54	CP934.....	57	MCEN27.....	87
CP615-2.....	54	CP934-1.....	57	MCEN27-1.....	87
CP615-3.....	54	CP936.....	58	MCEN27-2.....	88
CP616-13.....	50	CP938-1.....	55	MCEN27-3.....	88
CP616-15.....	50	CP941.....	18	MCEN27R.....	87
CP621.....	42	CP947.....	23	MCEN28.....	75
CP622-4.....	15	CP949-45.....	5	MCEN29.....	82
CP624-45.....	5	CP949-55.....	5	MCEN33.....	79
CP624-55.....	5	CP949-75.....	5	MCEN33DG.....	80
CP624-65.....	5	CP973.....	35	MCEN34.....	79
CP624-75.....	5	CP974.....	35	MCEN34DG.....	80
CP624LF-75.....	5	CP976.....	35	MCEN35.....	85
CP625.....	11	CP978.....	34	MCEN36.....	85
CP626.....	11	CP985.....	10	MCEN37-1-20.....	71
CP627.....	11	CP988-15.....	57	MCEN37-1-25.....	71
CP628.....	18	CP988-18.....	59	MCEN37-1-30.....	71
CP630.....	23	CP988-20.....	61	MCEN37-2-0.....	71
CP632.....	23	CP997.....	47	MCEN37-2-5.....	71
CP635.....	53	CP998-1.....	35	MCEN37-3-0.....	71
CP637.....	49	CP1100.....	35	MCEN37-3-5.....	71
CP640.....	39	CP1102.....	13	MCEN37D4.....	71
CP801-7.....	28	CP1103.....	13	MCEN38.....	89
CP801-10.....	28	CP1104.....	36	MCEN39.....	12
CP802.....	30	CP1105.....	36	MCEN39L.....	80
CP803.....	21	CP1106.....	53	MCEN41-1.....	92
CP806.....	32	CP1107.....	64	MCEN41D3.....	92
CP807.....	32	CP1109.....	38	MCEN41J.....	92
CP808-6.....	32			MCEN42.....	92
CP809.....	35			MCEN42-1.....	92
CP810.....	34			MCEN42J.....	92
CP814-1.....	39			MCEN42J1.....	92
CP814-2.....	39			MCEN43.....	82
CP814-3.....	39			MCEN44.....	78
CP821.....	14			MCEN49.....	89
CP822-10.....	18			MCEN50.....	78
CP822-12.....	18			MCEN53.....	85
CP822-14.....	18			MCEN54.....	94
CP823-5.....	28			MCEN54G.....	94
CP824-5.....	28			MCEN54H.....	94
CP825.....	16			MCEN54I.....	94
CP828.....	34			MCEN54P.....	94
CP905.....	34			MCEN55.....	76
CP907.....	27			MCEN56.....	79
CP919.....	45			MCEN56-1.....	79
CP919A.....	45			MCEN61.....	79
CP921.....	50			MCEN62A1.....	81

M

M832.....	56
M833.....	56

MCEN

MCEN2.....	5
MCEN3.....	82
MCEN4.....	82
MCEN4DG.....	80
MCEN5.....	82
MCEN5B.....	82
MCEN5BDG.....	80
MCEN5DG.....	80
MCEN10.....	12
MCEN11.....	96

^(D) Distribué par Integra MicroFrance SAS (France) - Voir tableau d'équivalence annexe pour la référence du fabricant correspondante

MCEN62A1DG	80	MCEN87W	74	MCEN151	100
MCEN62A2	81	MCEN88SC	74	MCEN152.....	100
MCEN62A2DG.....	80	MCEN90	79	MCEN153.....	100
MCEN62A3	81	MCEN90DG.....	80	MCEN154.....	100
MCEN62B1	81	MCEN91	79	MCEN155.....	100
MCEN62B1DG	80	MCEN91B	79	MCEN156	100
MCEN62B2	81	MCEN91BDG.....	80	MCEN157.....	100
MCEN62B2DG.....	80	MCEN91DG.....	80	MCEN158.....	100
MCEN62B3.....	81	MCEN96.....	85	MCEN161.....	101
MCEN62T1.....	81	MCEN97	85	MCEN162	101
MCEN62T1DG	80	MCEN98.....	91	MCEN163.....	101
MCEN62T2	81	MCEN99.....	85	MCEN164	101
MCEN62T2DG.....	80	MCEN100-2-0	96	MCEN165.....	101
MCEN62T3.....	81	MCEN100-2-5	96	MCEN167.....	101
MCEN64.....	95	MCEN100-3-0	96	MCEN168	101
MCEN65.....	90	MCEN100-3-5.....	96	MCEN169	101
MCEN66.....	90	MCEN101.....	96	MCEN170	101
MCEN67	90	MCEN102	96	MCEN171	101
MCEN67-1.....	90	MCEN103	78	MCEN183.....	72
MCEN67-2	90	MCEN103LDG.....	71	MCEN184	72
MCEN68.....	86	MCEN104.....	24	MCEN186	72
MCEN68ADG.....	80	MCEN105.....	96	MCEN187.....	12
MCEN68BDG.....	80	MCEN106.....	24	MCEN190.....	104
MCEN68CDG.....	80	MCEN107.....	24	MCEN191.....	104
MCEN77-3-0.....	72	MCEN109.....	24	MCEN192	104
MCEN77-3-5.....	72	MCEN110.....	98	MCEN193.....	104
MCEN78J30.....	72	MCEN111.....	98	MCEN194	104
MCEN78J40	72	MCEN112	98	MCEN195	104
MCEN79J25.....	72	MCEN114	98	MCEN211.....	93
MCEN79J30	72	MCEN115-6	98	MCEN211S.....	93
MCEN79J40	72	MCEN115-8	98	MCEN212	93
MCEN80.....	74	MCEN115-9	98	MCEN212S	93
MCEN81-C	74	MCEN116	98	MCEN213.....	93
MCEN81O.....	74	MCEN117	98	MCEN213S	93
MCEN81O1	74	MCEN118	98	MCEN214	103
MCEN81O2	74	MCEN120	98	MCEN215.....	103
MCEN81-S.....	74	MCEN127.....	78	MCEN216L	103
MCEN81-W	74	MCEN128	96	MCEN216R.....	103
MCEN82-C.....	74	MCEN130	102	MCEN217L.....	103
MCEN82O	74	MCEN131	102	MCEN217R	103
MCEN82O5.....	74	MCEN133.....	102	MCEN217S	103
MCEN82O6.....	74	MCEN134.....	102	MCEN217U.....	103
MCEN82-S	74	MCEN135.....	102	MCEN218	104
MCEN82-W.....	74	MCEN138.....	103	MCEN328S.....	105
MCEN83-C.....	74	MCEN138S	103	MCEN328U	105
MCEN83O	74	MCEN139.....	103	MCEN329	105
MCEN83OL	74	MCEN139A	103	MCEN330	105
MCEN83-S.....	74	MCEN140	103	MCEN344S.....	105
MCEN83-W	74	MCEN140A.....	103	MCEN344U	105
MCEN84S(D).....	74	MCEN141.....	103	MCEN344V	105
MCEN87C.....	74	MCEN141A.....	103	MCEN345	105
MCEN87O3	74	MCEN142	103	MCEN346	105
MCEN87O4	74	MCEN147.....	103	MCEN347	105
MCEN87-S.....	74	MCEN149W.....	102, 103	MCEN348	105

MCEN349	105
MCEN350	105
MCEN350H	81
MCEN350V	81
MCEN351	105
MCEN360H	81
MCEN360V	81
MCEN364	105
MCEN365	105
MCEN371D4	71
MCEN371D35	71
MCEN641	95
MCEN643	95
MCEN713	77
MCEN720	99
MCEN721	99
MCEN723	99
MCEN728DG	80
MCEN730	96
MCEN760	99
MCEN761	99
MCEN762	99
MCEN763	99
MCEN764	12
MCEN765	12
MCEN766	72
MCEN767	72
MCEN768	99
MCEN769	99
MCEN770B25	71
MCEN770B30	71
MCEN770J30	69
MCEN770J40	69
MCEN960H	81

MCL

MCL38N	5
MCL75	5
MCL170(D)(1)	5
MCL171(D)(1)	5
MCL173(D)(1)	5
MCL174(D)(1)	5
MCL197(D)(1)	5

MCLW

MCLW10	103
MCLW11	103

MCO

MCO1B	70
MCO201-2-5	69
MCO201-3-0	69
MCO214-13-10	28
MCO214-13-20	28
MCO214-13-40	28
MCO214-13-60	28
MCO214-13-80	28
MCO233	4
MCO237	4
MCO305	10
MCO311-1-0	70
MCO311-1-2	70
MCO311-1-5	70
MCO311-1-8	70
MCO311-2-0	70
MCO311-2-5	70
MCO311-3-0	70
MCO311-3-5	70
MCO311-4-0	70
MCO731 ^(D)	106
MCO770-1-5	69
MCO770-2-0	69
MCO770-2-5	69
MCO770-3-0	69
MCO770-3-5	69
MCO770-4-0	69
MCO771-2-5	69
MCO771-3-0	69
MCO771-4-0	69
MCO772	70
MCO775-1	70
MCO776	70
MCO803	10
MCO805	3
MCO805A	3
MCO807	3
MCO950	3
MCO978	6
MCO978S	6
MCO979	16
MCO980	6
MCO981	6
MCO981D	6
MCO983-4	6
MCO988	16
MCO995	26

MCSK

MCSK1	97
MCSK2	97
MCSK3	97
MCSK4	97
MCSK5	97
MCSK6	97

P

P761-7	65
P761-8	65
P762-2	66
P762-4	66
P763	67
P764-1	66
P764-3	66
P764-5	66
P764-7	66
P764-11	66
P765-14	67
P765-16	67
P769	67

S

SCP337A	13
---------------	----

^(D) Distribué par Integra MicroFrance SAS (France) - Voir tableau d'équivalence annexe pour la référence du fabricant correspondante

**Tableau d'équivalence
à titre informatif**

Integra MicroFrance® référence produit	Référence fabricant équivalente
1003IG	M3IG
1003LI	M3LI
1004IG	M4IG
1005I	M5I
7746A	651
7746B	650
7776	76.51.20
7872-24	1224
7876-100	310
7876-120	312
7876-160	316
7876-60	306
7876-80	308
7903-50-5	13.202
AQ1728	PS-1728
MCEN84S	MCEN84S
MCL38N	EC-BLU50U090
MCL170 ⁽¹⁾	CO101
MCL171 ⁽¹⁾	CO201
MCL173 ⁽¹⁾	CO100
MCL174 ⁽¹⁾	CO200
MCL197 ⁽¹⁾	CO103
MCO731	430490

⁽¹⁾ Produit non dispositif médical

Fabricants :



Integra MicroFrance SAS (France)
Le Pavillon ■ 03160 Saint Aubin le Monial ■ France

Fabricants avec produits du catalogue uniquement de classe I



HEMODIA SAS
85, rue du Chêne Vert
31670 LABEGE ■ France



Unimed SA
Rue du Grand-Pré 10
1007 Lausanne ■ Suisse



Swann Morton Ltd
Penn Works ■ Owlerton Green ■ Sheffield
South Yorkshire S6 2BJ ■ Royaume Uni



Agencinox
Zone Industrielle
89110 Aillant sur Tholon ■ France



Concorde Import Export
B.P. 37
92300 Levallois-Perret ■ France



Chemische Fabrik Dr. Weigert GmbH & Co.
Mühlenhagen
D-20539 Hamburg ■ Allemagne



Medicon eG
Gaensaecker 15
D-78832 Tuttlingen ■ Allemagne



Qfix
440 Church Road
Avondale ■ PA 19311 USA



Medical device & QA Services Ltd
76, Stockport Road ■ Timperley
Cheshire ■ WA15 75N ■ Royaume Uni



Sunoptic Technologies®, LLC
6018 Bowdendale Avenue
Jacksonville ■ FL 32216 USA



RMS - UK Limited
28 Trinity Road ■ Nailsea
Somerset ■ BS48 4NU ■ Royaume Uni

Informations supplémentaires pour les clients Europe, Moyen-Orient, Afrique :

Attention : la loi restreint la vente de ces appareils à des médecins ou suite à leur prescription.

Toutes les références mentionnées dans ce document sont marquées CE en accord avec la directive du conseil Européen 93/42/EEC sur les dispositifs médicaux et ses amendements.

Les références qui ne sont pas des dispositifs médicaux sont identifiées avec la mention "PRODUIT NON DISPOSITIF MEDICAL".

Les produits mentionnés dans ce document ne sont pas inscrits à la Liste des Produits et Prestations Remboursables (LPPR) mentionnée à l'article L165-1 du code de la sécurité sociale et ne sont pas éligibles au remboursement par l'Assurance Maladie.

Tous les textes et diagrammes contenus dans ce catalogue sont à considérer comme des notes d'orientations et sont à but illustratif seulement. Aucune information contenue dans ce catalogue n'a pour but de se substituer au mode d'emploi présent dans chaque emballage des produits Integra. Veuillez toujours vous référer au mode d'emploi approprié pour les instructions cliniques complètes. Pour des informations supplémentaires techniques et cliniques sur les produits Integra, veuillez contacter votre spécialiste Integra. Lire attentivement la notice d'instructions du produit.

La disponibilité de ces produits peut varier d'un pays ou d'une région à l'autre du fait de procédures d'enregistrement réglementaires ou de conditions de vente locales spécifiques.

Les produits identifiés par le symbole ^(®) sont distribués par Integra MicroFrance SAS (France).

Produits de classe I, Im, IIa, IIb. Pour plus d'informations sur la classe des produits, veuillez contacter le Service Client Integra.

Date de dernière révision: 12/2020

Pour plus d'informations, veuillez contacter le service client :

Europe, Moyen-Orient, Afrique

International : +33 (0) 4 37 47 59 50 ■ +33 (0) 4 37 47 59 25 (Fax) ■ csema@integralife.com
France : +33 (0) 4 37 47 59 10 ■ +33 (0) 4 37 47 59 29 (Fax) ■ custservfrance@integralife.com
Belgique & Luxembourg : +32 (0) 2 257 4130 ■ +32 (0) 2 253 2466 (Fax) ■ custsvcbenelux@integralife.com
Royaume-Uni : +44 (0) 1264 312 725 ■ +44 (0) 1264 312 821 (Fax) ■ custsvcs.uk@integralife.com
Pays-Bas : +31 (0) 852 083 167 ■ +31 (0) 207 093 627 (Fax) ■ custsvcnetherlands@integralife.com
Italie : +39 (0) 2 577 8921 ■ +39 (0) 2 575 113 71 (Fax) ■ custsvcityal@integralife.com
integralife.eu/contact

MicroFrance, Integra et le logo Integra sont des marques enregistrées de Integra LifeSciences Corporation ou de ses filiales aux USA et/ou dans d'autres pays. Toutes les autres marques et noms de produits sont la propriété de leurs propriétaires respectifs.

© 2020 Integra LifeSciences Corporation. Tous droits réservés.

0329660-5-FR

DOCUMENT DESTINE A L'EUROPE, AU MOYEN-ORIENT ET A L'AFRIQUE UNIQUEMENT.