

Integra[®] MicroFrance[®]
Integra ENT - Throat catalogue

Table of contents	ii	Neck surgery	16
Warranty and Customer Service Information	vi	Facial nerve dissector	16
Indications / Contraindications	vii	Tracheal dilator	16
Diagnosis	2	Curved dissector	16
Tongue depressor	2	Shear	16
Kilner mouth-gag	3	Tracheal retractor	16
Davis-Boyle mouth-gag	4	Grooved director	16
April mouth-gag	5	Curved scissors	16
Mouth-gag, complete	6	Micro surgery	17-18
Morinière mouth-gag	7-9	Micro irrigation tube	17
Presentation	7	Micro vascular clamp	17
Composition of the mouth-gag	8	Micro dissecting forceps	17
Add-ins	9	Jeweler forceps	17
Tongue depressor	10	Approximator	17
Tongue depressor with suction tube and basket	10	Needle-holder	18
Tongue depressor with basket	10	Micro scissors	18
Tonsil adenoid forceps	11	Silicone cover	18
Tonsil forceps with teeth	11	Suction tube with finger control	19
Tonsil haemostatic forceps	11	Micro suction irrigation tube	19
Adenoid forceps	11	Jankowski	19
Tonsil adenoid instruments	12-13	Lempert	19
Scalpel handle	12	Wertheimer	19
Tonsil knife	12	Elevator - Raspatory	20
Blunt curette	12	Scalpel handle	21
Curved elevator	12	Curved raspatory	22
Double-ended elevator	12	Other raspatory	23
Suction tube with finger control	12	Sharp raspatory	23
Elevator and dissector	12	Curved raspatory	23
Monopolar elevator suction tube	12	Straight raspatory	23
Monopolar electrode pick	12	Retractor	24-25
Monopolar cable	12	Sharp hook	24
Curved elevator	13	Double retractor	24
Adenoid curette	14	Blunt retractor	24
Twitth basket	14	Sharp retractor, articulated	24
without basket	14	Retractor with prongs	25
Tonsil snare, Amygdalotome	15	Large self-retaining retractor	26
Amygdalotome, tonsil blade	15	Articulated self-retaining retractor	27
Amygdalotome, handle	15	Malleable blade retractor - Double retractor	28
Tonsil snare	15	Blunt retractor - Double retractor	29
Snare wire	15	Small scissors, pointed, matt finish	30
Stainless steel wire	15	Long scissors, pointed	31
		Small scissors, blunt, matt finish	32
		Long curved scissors, blunt	33

Small Metzenbaum scissors, matt finish	34	Hypopharyngoscope	55
Large Metzenbaum scissors	35	Fiber	55
Mayo scissors, matt finish	36	Suction tube	55
Fine dissecting forceps	37	Forceps	55
with teeth and plateform	37	Diverticuloscope	56
with serrated jaws	37	Diverticuloscope	56
with teeth	37	Suction tube	56
Adson dissecting forceps	38	Fiber	56
Medium dissecting forceps	39-40	Laryngoscope holder, Cold Light	57
with serrated jaws	39-40	Laryngoscope holder	57
with teeth	39-40	Plate for Chest holder	57
with teeth and plateform	39-40	Operating table clamp	57
Dissecting forceps, 180mm	41	Cold light cable	57
Dissecting forceps, 200mm	42	Adapter for cold light cable	57
Medium bipolar dissection forceps	43	Open laryngoscope	58
Bipolar dissecting forceps, 200mm	44	Laryngoscope without suction tube	59
Irrigation bipolar forceps	45	Laryngoscope with suction tube	60
Medium monopolar dissecting forceps	46	Sataloff laryngoscope	61
Adson	46	Micro suction tube	62
with smooth jaws	46	Suction tube	62
with serrated jaws	46	Blunt eyes suction tube	62
with teeth	46	Insulated suction tube with finger control	62
Monopolar cable	46	Suction tube with finger control	62
Large monopolar dissecting forceps	47	Sataloff suction tube	62
Needle-holder, tungsten jaws	48	Bouchayer Instruments	63
Large tungsten needle-holder	49	Forceps, serrated jaws	63
Fine haemostatic forceps	50	Heart-shaped forceps	63
Medium haemostatic forceps	51	Cup forceps	63
Strong haemostatic forceps	52	Bouchayer Instruments, Working length 220mm	64
With teeth, «T» tip	52	Micro laryngeal scissors	64
with serrated jaws	52	Lancet knife	64
Other haemostatic forceps	53	Lancet knife, handle and 3 blades	64
Esophagoscope	54	Micro laryngeal elevator	64
Esophagoscope	54	Micro retractor forceps	64
Fiber	54	Needle-holder	64
Handle	54	Pérouse Instruments, Working length 220mm	65
Suction tube	54	Micro laryngeal elevator	65
Forceps	54	Stylet handle	65
Sterilization case	54	Tungsten needle-holder insert	65
Hypopharyngoscope	55	Abitbol Instruments	66
		Insulated suction tube with finger control	66
		Monopolar forceps with suction	66
		Monopolar cable	66

Other laryngeal instruments	67-68	Benninger instruments	74
Scalpel handle	67	Scissors	74
Knife blade	67	Cup forceps	74
Stylet handle	67	Heart-shaped grasper	74
Tungsten needle-holder insert	67	Needle-holder	74
Adapter for cleaning insert	67	Knot pusher	74
Needle-Holder, tungsten jaws	67		
Sickle knife	67	Henry set - 3.0mm	75
Knife	67	Scissors	75
Hook	67	Monopolar hook	75
Retractor	67	Palpation probe	75
Knife	68	Forceps, fenestrated jaws	75
Micro scissors	68	Forceps, alligator serrated jaws	75
Laryngeal sprinkler	68	Trocar	75
Injection needle	68	Trocar holder ring	75
Double probe	68		
		Terris thyroidectomy Instrument Set - Robotic thyroid surgery	76
Micro coagulation	69	Double retractor	76
Monopolar suction tube with finger control	69	Curved elevator	76
Monopolar electrode pick	69	Peanut holder	76
Monopolar cable	69	Malleable suction tube elevator	76
Bipolar forceps	69	Robotic thyroid surgery	76
Bipolar cable	69		
		Mini invasive instrumentation Ø 3.5mm	77
Micro injection	70	Metallic trocar with silicone valve	77
Casiano transcervical laryngeal injection	70	Metallic trocar with magnetic valve	77
Pistol for injection	70		
Luer-lock adapter	70	Pediatric Instrumentation Ø 3.5mm	78-86
Injection needle	70	Composite trocar with silicone valve	78
		Suction irrigation tube	79
Sataloff instruments	71-72	Retractable knife	79
Injection needle	71	Monopolar hook	79
Micro knife	71	Bipolar forceps	80
Micro blunt hook	71	2-piece : Insert Jaws with insulated tube	81
Micro curette for cyst	71	Cleaning adapter	81
Micro spatula	71	Angled handle	82
Micro hook	71	Axial handle	83
Mirror	71	Ergonomic handle	84
Micro ball dissector	71	Scissors, 1-piece	85
Instrument holder	71	Forceps, 1-piece	85
Cotton carrier	71	De Lagausie instruments	86
Cup forceps	72	Needle-holder	86
Heart-shaped grasper	72		
Alligator forceps	72	Stainless steel cup, Tray, Surgical oil	87
		Stainless steel sterilization case	88
Sataloff indirect Laryngeal instruments	73	Numerical index	89
Injection needle	73	Table for corresponding manufacturer part numbers For information purposes only	95
Laryngeal dilator	73		
Micro suction tube	73		
Micro knife	73		
Micro scissors	73		
Micro vascular knife	73		
Micro forceps	73		
Instrument holder	73		
Stainless steel sterilization case	73		

Integra Limited Warranty

Please refer to the warranty included in the packaging of each product to know the applicable warranty.

Contacts Customer service:

International

+33 (0) 4 37 47 59 50
+33 (0) 4 37 47 59 25 (fax)
csemea@integralife.com

France

+33 (0) 4 37 47 59 10
+33 (0) 4 37 47 59 29 (Fax)
custservfrance@integralife.com

Belgium & Luxembourg

+32 (0) 2 257 4130
+32 (0) 2 253 2466 (Fax)
custsvcbenelux@integralife.com

United Kingdom

+44 (0) 1264 312 725
+44 (0) 1264 312 821 (Fax)
custsvcs.uk@integralife.com

Netherlands

+31(0) 852 083 167
+31(0) 207 093 627 (Fax)
custsvcnetherlands@integralife.com

Italy

+39 (0) 2 577 8921
+39 (0) 2 575 113 71 (Fax)
custsvcitaly@integralife.com

MicroFrance® ENT Instrumentation

INDICATIONS

- All the medical devices showed in this catalogue have indications for diagnosis and/or ENT surgery.
- Sizes are not contractual and are given for information purposes only.

CONTRAINDICATIONS

- Do not use in indications other than the indications mentioned in the DFU or Labeling.

How to read the catalogue

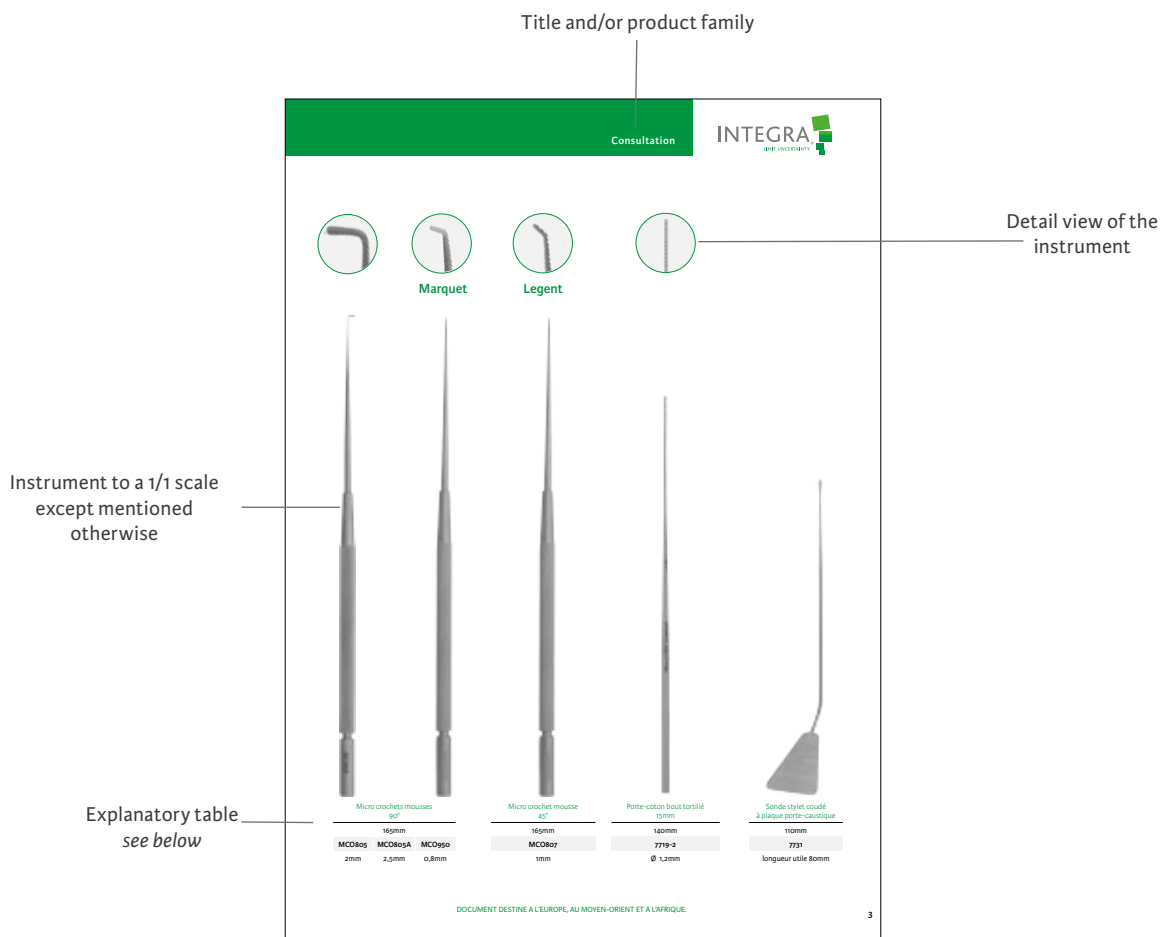

Explanation of the table reference and complementary product description

Title or subtitles	
Global complementary description	
Product ref.1	complementary description 1
Product ref.2	complementary description 2

Tongue depressor

Doyen



Double

150mm - Pack 10

7798T^(D)

Doyen



Double

150mm - Pack 10

7798T1^(D)

Canuyt



Fenestrated

185mm

7796

^(D) Distributed by Integra MicroFrance SAS (France) - For corresponding manufacturer part numbers, see table in annex

Scale 2/3



Kilner

Ring blade

7803S-3	7803S-2	7803S-1
40x75mm n°3	35x70mm n°2	30x60mm n°1



Kilner

Frame

7803C



Palatine blade

7803B

without fixing upper jaw



Camo® dental mouth guard

7960T40^(D)

Pack 40 - Single use



Chabolle

Ring blade

MCR3A	MCR2A
40x90mm n°3	40x80mm n°2



Silicone dental mouth guard

7802P

Pack 2

^(D) Distributed by Integra MicroFrance SAS (France) - For corresponding manufacturer part numbers, see table in annex



Davis-Boyle

Frame
7802C



Camo® dental mouth guard
7960T40^(D)
Pack 40 - Single use



Silicone dental mouth guard
7802P
Pack 2



Davis-Boyle

Blade with suction tube

7802S-5	7802S-4	7802S-3	7802S-2	7802S-1
20x105mm n°5	25x90mm n°4	25x75mm n°3	25x60mm n°2	20x25mm n°1

^(D) Distributed by Integra MicroFrance SAS (France) - For corresponding manufacturer part numbers, see table in annex

Scale 2/3



Designed for the use of handpieces

April

Frame

MCL201

right

April

Frame

MCL200

left



Camo[®] dental mouth guard

7960T40^(D)

Pack 40 - Single use



Silicone dental mouth guard

7802P

Pack 2

^(D) Distributed by Integra MicroFrance SAS (France) - For corresponding manufacturer part numbers, see table in annex

Scale 1/2

Masson

7809MF

140mm



Doyen

7821B

120mm

7821A

140mm



7821B



7805-11

Seemann-Seiffert

7805-11

110mm

7805-13

130mm

Jennings

7804-9

90mm

7804-11

110mm

7804-13

130mm

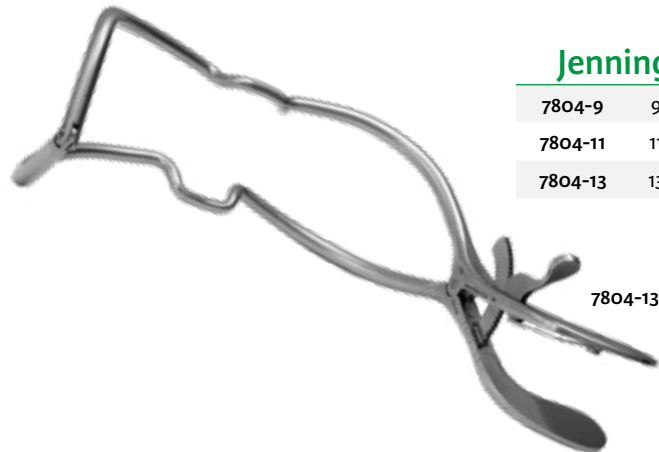

7804-13

Presentation of Morinière mouth-gag for mini invasive surgery

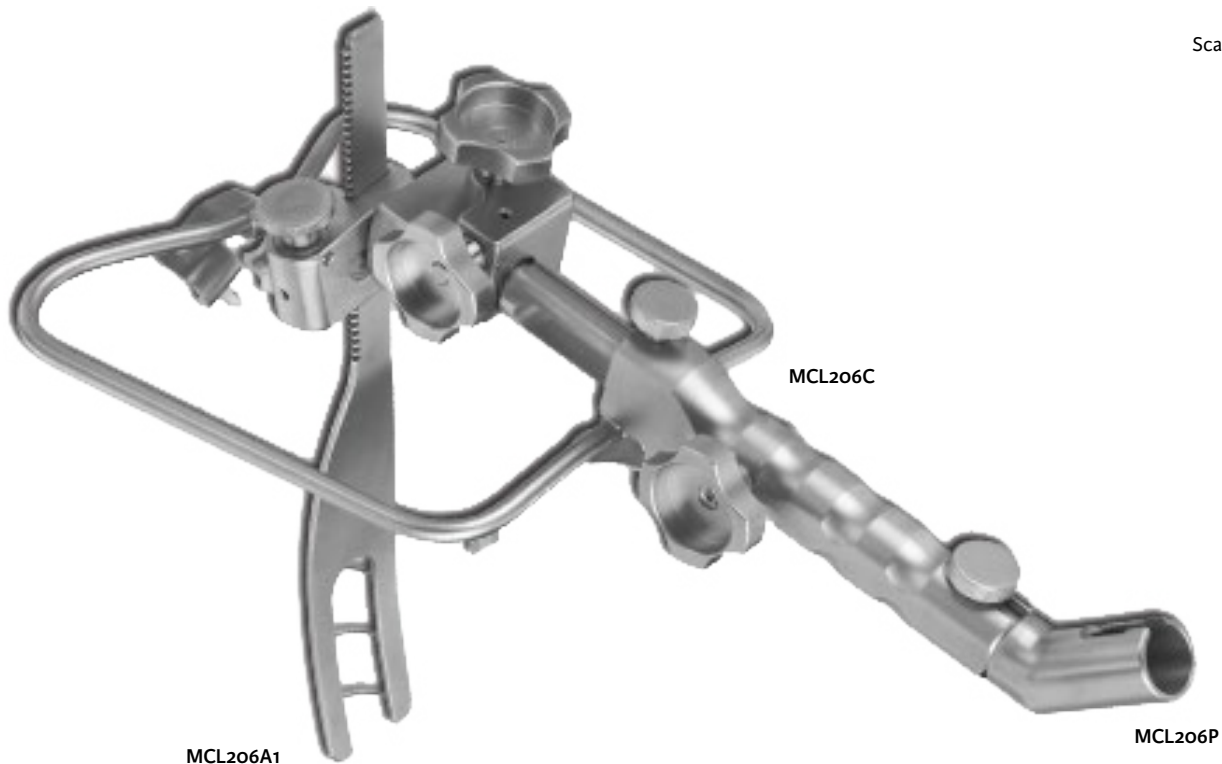

Scale 1/2

MCL206A1

MCL206C

MCL206P

Frame MCL206C
with ring blade MCL206A1
and adapter MCL206P

Composition of the mouth-gag

Scale 1/3

MCL206 Mouth-gag, mini invasive surgery, complete with 1 frame, 5 blades, 1 locking key and 1 angled intermediate piece.

Frame

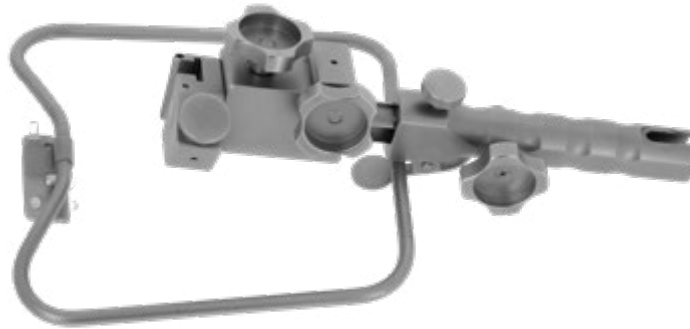

MCL206C

Blade

MCL206A1 35x120mm ring blade



MCL206A2 35x120mm



MCL206A3 35x110mm



MCL206A4 40x85mm



MCL206A5 35x65mm



Locking key

Angled intermediate piece

MCL206K



MCL206P



Additional accessories, not included in ref. MCL206

MCL206A6 larynx blade 140x20mm



MCL206A7 Zenker's diverticulum blade 180x23mm



Add-ins instruments

Picture for information, without scale

Dental mouth guard

7802P Silicone dental mouth guard (Pk 2)

7960T40^(D) Camo® dental mouth guard Single use - (Pk 40)



Fiberoptic

MCL38N^(D) Fiberoptic, 2200mm without adapter

Adapters

MCL170^{(D)(1)}

MCL171^{(D)(1)}

MCL173^{(D)(1)}

MCL174^{(D)(1)}

MCL197^{(D)(1)}

Wolf

Storz

Olympus

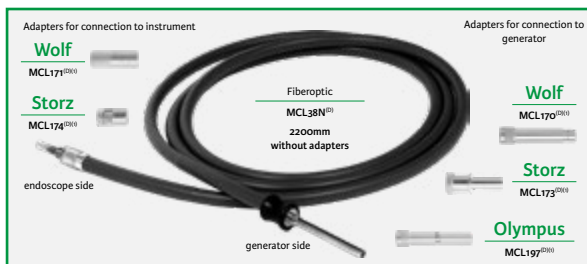

⁽¹⁾ Not a medical product

Light fiber

MCL89-2 Light fiber



Chest holder

MCL76 Laryngoscope arm holder without MCL35

MCL35 Plate for chest holder



Suction tube

MCL89-1 Suction tube for MCL206

MCL100 Blunt eyes suction tube



Container

7874MF-34 Stainless steel sterilization case 380x205x85mm 340x200x80mm



Silicone cover

MCM25-3 Silicone cover

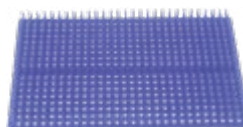

^(D) Distributed by Integra MicroFrance SAS (France) - For corresponding manufacturer part numbers, see table in annex

Portmann

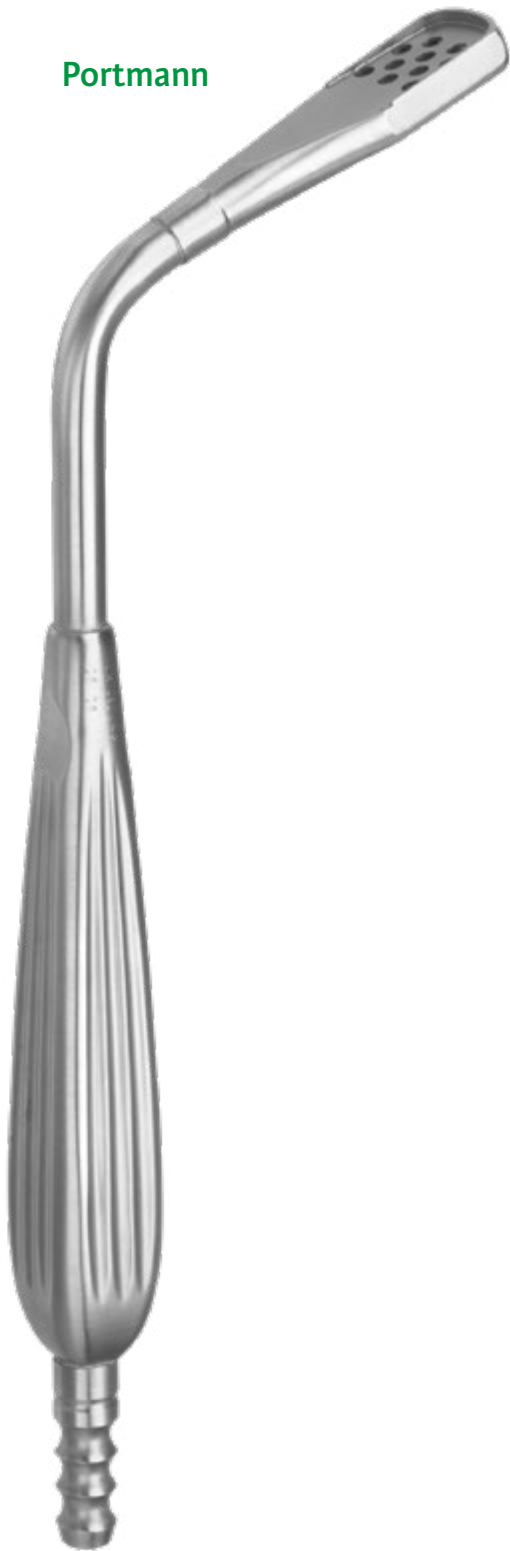

200mm

7857

Lecouteur



160mm

7800MF

Le Mée



7797-2

170mm

7797-1 small

7797-2 large

Scale 1/2

Birkett



Schmidt



Négus



Bourgeois



Portmann



Chatelier

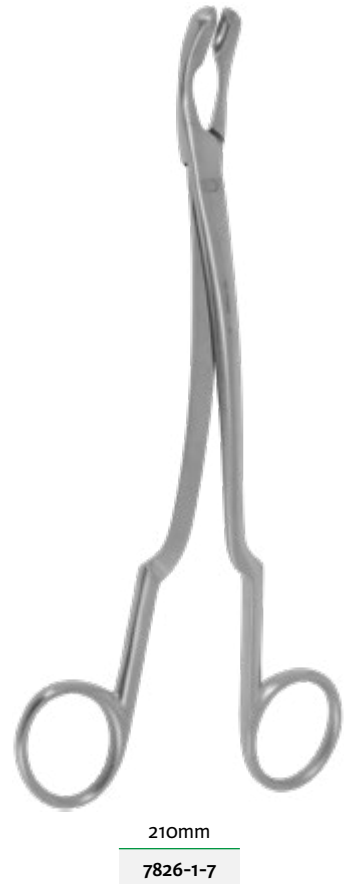

Scale 1/2

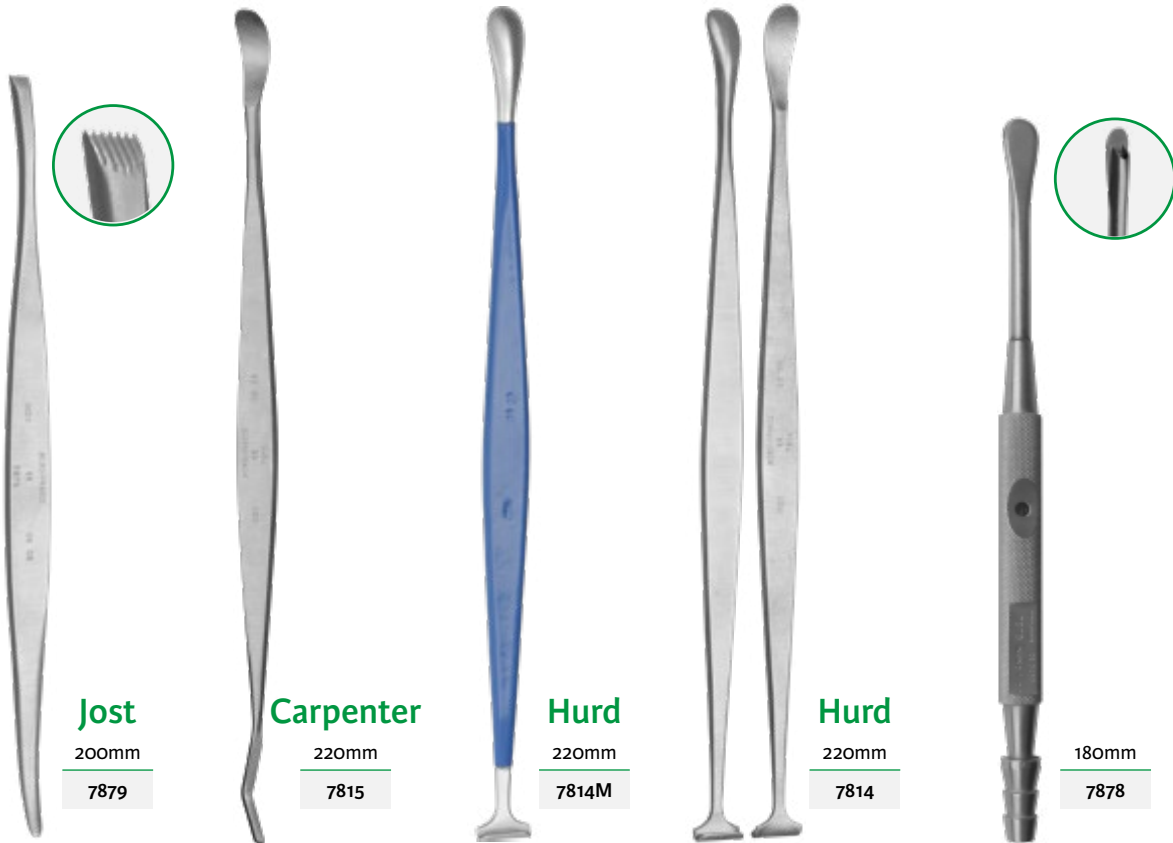

Monopolar cables
3.5m

CP391E
Erbe ACC ICC/VIO
Storz Wolf

CP391M
Aesculap Berchtold
Lamidey
Martin Erbe T Serie
Sutter BM-780 II

CP391V
Bowa Bovie
Conmed Valleylab

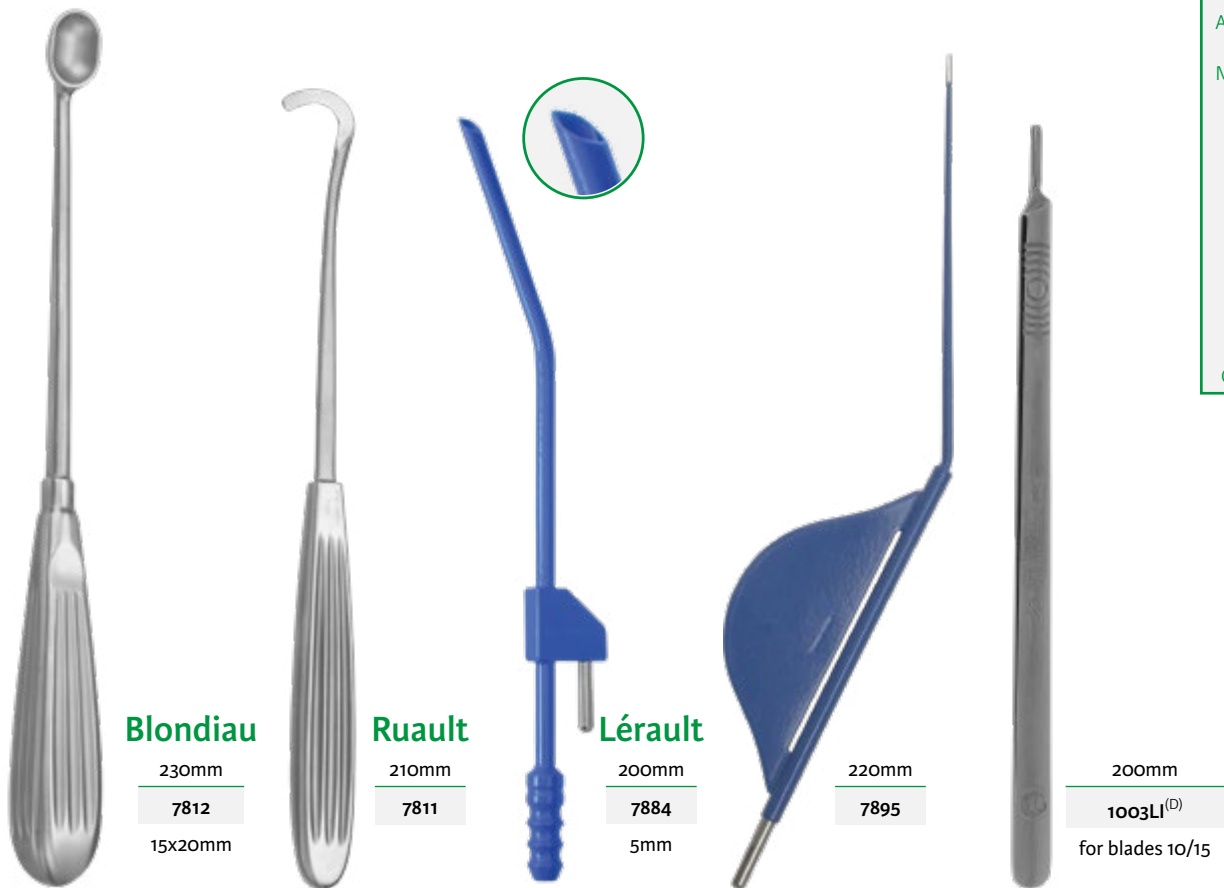

^(D) Distributed by Integra MicroFrance SAS (France) - For corresponding manufacturer part numbers, see table in annex

Hurd

Elevator
225mm

3734042

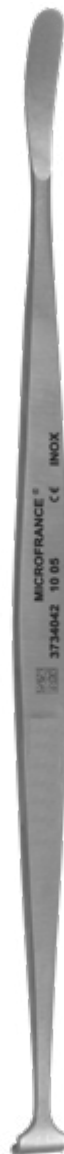

7mm

11mm

Scale 2/3

Moure



7828-1-13

Moure



7828-16

Lermoyez



7829-10

220mm - without basket



7828-1-10 6/10mm



7828-1-13 8/13mm



7828-1-16 10/16mm



7828-1-19 12/19mm

220mm - with basket



7828-10 6/10mm



7828-13 8/13mm



7828-16 10/16mm



7828-19 12/19mm

220mm - without basket



7829-10 5/10mm

7829-13 7/13mm

7829-16 9/16mm

7829-19 13/19mm

Scale 1/2

Working length «L»

Sluder

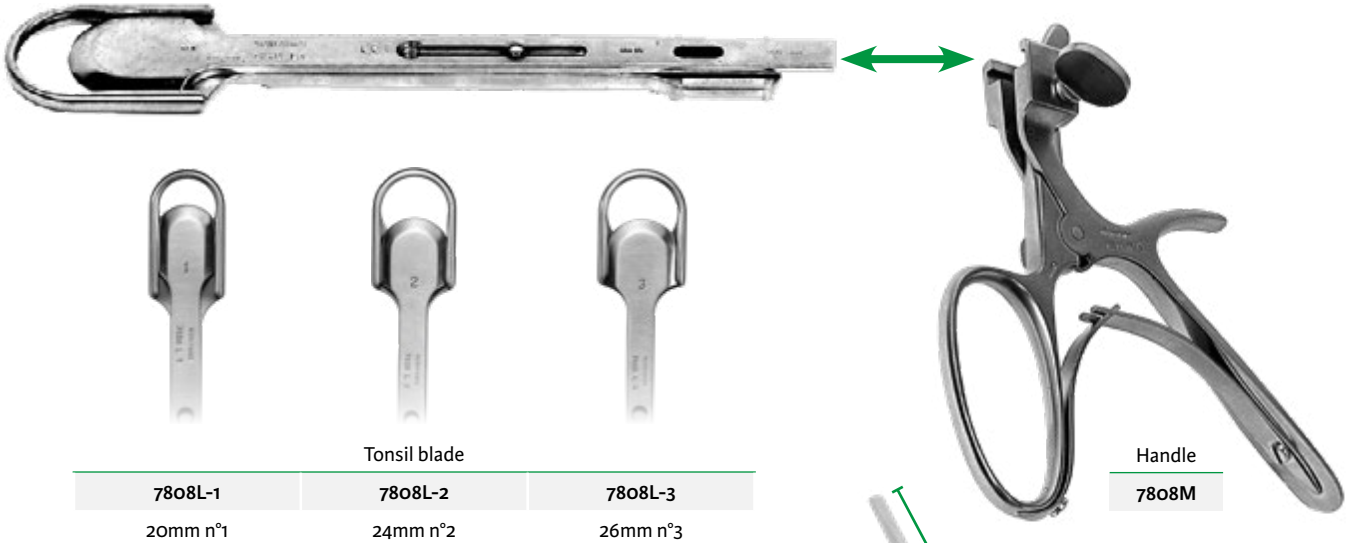

Brünings

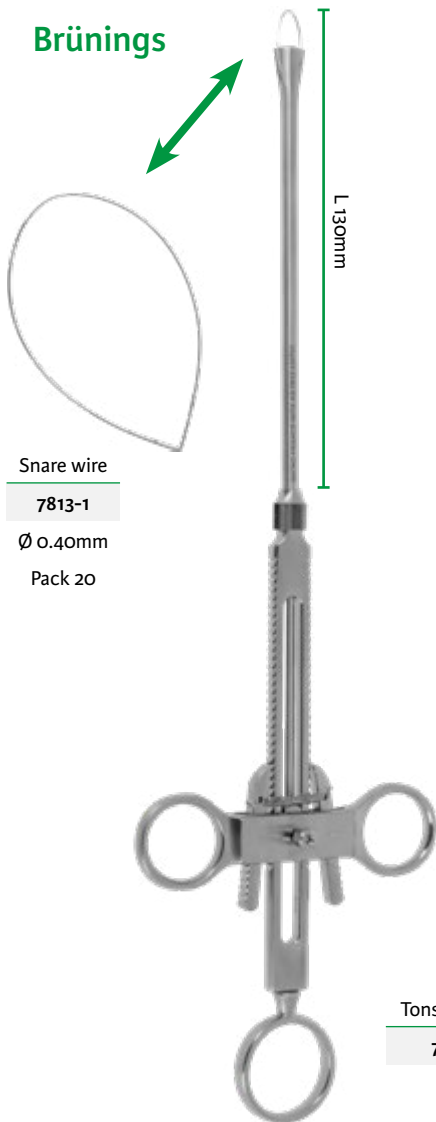

Vacher

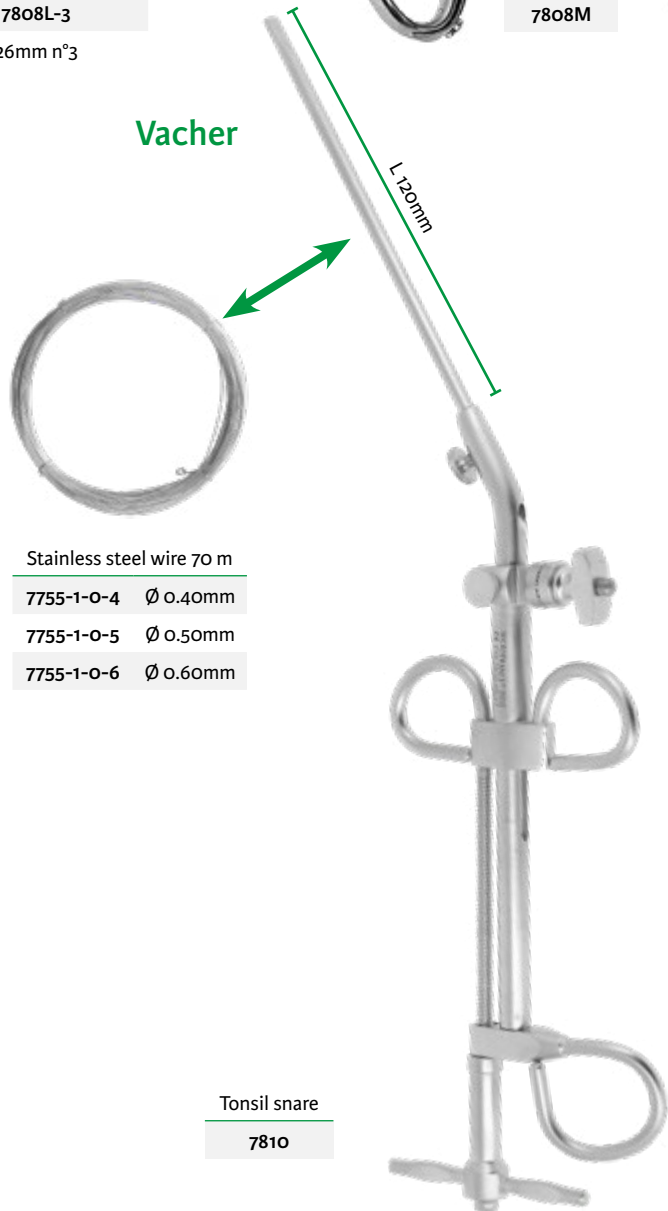

Laborde



Tracheal dilator

7840

120mm 80°

Guerrier



Tracheal retractor

7838

180mm

Marie



Director

7839

145mm

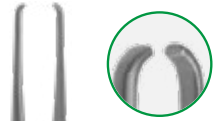

Facial nerve dissector

7830M

160mm

Moure



Shear serrated blades

7835

200mm

Guerrier



«S» curved scissors

7921

180mm

O'Shaugnessy



Curved dissector

7837-18

180mm

Redon



7920

140mm

Working length «L»

Micro irrigation tube



MCM10-0-5 Ø 0.5mm L 30mm
MCM10-1-0 Ø 1mm

Approximator L 13mm

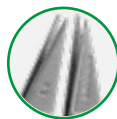

Large

MCM13

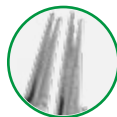

Small

MCM13-1



MCM13

Gilbert O'Brien

Micro dissecting forceps - 150mm



MCM4BISR



MCM4BISR

1x2 teeth and platform

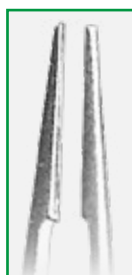

MCM4R

Smooth jaws with plate

Jeweler forceps



130mm

MCM973D3 n°3

MCM973D5 n°5

Micro ciseaux

Vanas



MCM7BISR

8mm
Blunt curved

Vanas



MCM7R

8mm - serrated
straight blades



MCM970

8mm
atraumatic curved



MCM7BISR
150mm

Micro porte-aiguille

O'Brien



MCM12R

5x0.3mm
smooth curved jaws

Barraquer-Comtet



MCM1R

8mm
smooth straight jaws



MCM12R
150mm

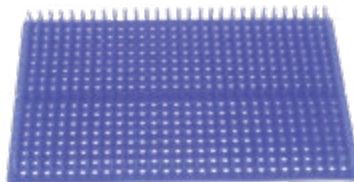

MCM25-3

210x130mm

Sébileau



190mm
CP985
5mm

Fleury



180mm
MCO305
8.5mm

Freer



160mm
MCO803
2.5mm

Howarth



185mm
CP611
5mm



220mm
CP625

Cottle



220mm
CP626

McKenty



240mm
CP627



120mm

160mm

200mm

150mm

120mm

1003IG^(D)

1005I^(D)

1003LI^(D)

CP821

1004IG^(D)

N° 3

N° 7

N° 3L

N° 3

N° 4

Utilisation avec lames 11/15

lames 23

^(D) Distributed by Integra MicroFrance SAS (France) - For corresponding manufacturer part numbers, see table in annex

Farabeuf

Fleury

Sébileau

Plester



150mm

7787-10

10mm



170mm

MCO979

6,5mm



150mm

CP825

4mm



180mm

MCO988

7,5mm



195mm

3724059

6,5mm

Joseph

Obwegeser



180mm

CP310

5mm



180mm

CP310D

5mm
straight



180mm

CP310E

4mm

CP310



CP344A

Obwegeser

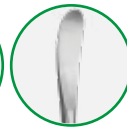
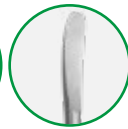
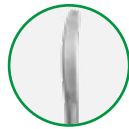

180mm

CP344A

5mm

CP344B

7mm

CP344C

11mm

Obwegeser-Tessier

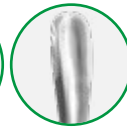
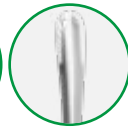

180mm - sharp

CP344AT

5mm

CP344BT

7mm

CP344CT

11mm

Obwegeser



190mm

CP344D

7mm
curved

CP344E

7mm
very curved

Obwegeser-Tessier

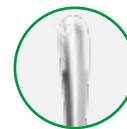

190mm - tranchante

CP344DT

7mm
curved

CP344ET

7mm
very curved

Farabeuf



140mm	120mm
7768-1	7768
Pk 2	Pk 2

Desmarres



140mm
CP822-12
12mm
CP822-10
10mm
CP822-14
14mm

Gillies



180mm
CP17
3mm
CP17-1
2mm

Gillies



145mm
CP17-3
2mm
CP17-2
3mm



145mm
CP628
5mm

Humby



110mm
CP941
articulated

Knapp



150mm

3714027

8mm

3714028

blunt

Volkman



140mm

CP21-3

pointu

CP21A-3

blunt



150mm

7782-1-2

Senn-Miller



180mm

CP335



160mm

CP609

3 sharp prongs

Weitlaner



curved

160mm

0-28-7

sharp prongs

Bizeau

165mm

MCL359

blades 20x30mm

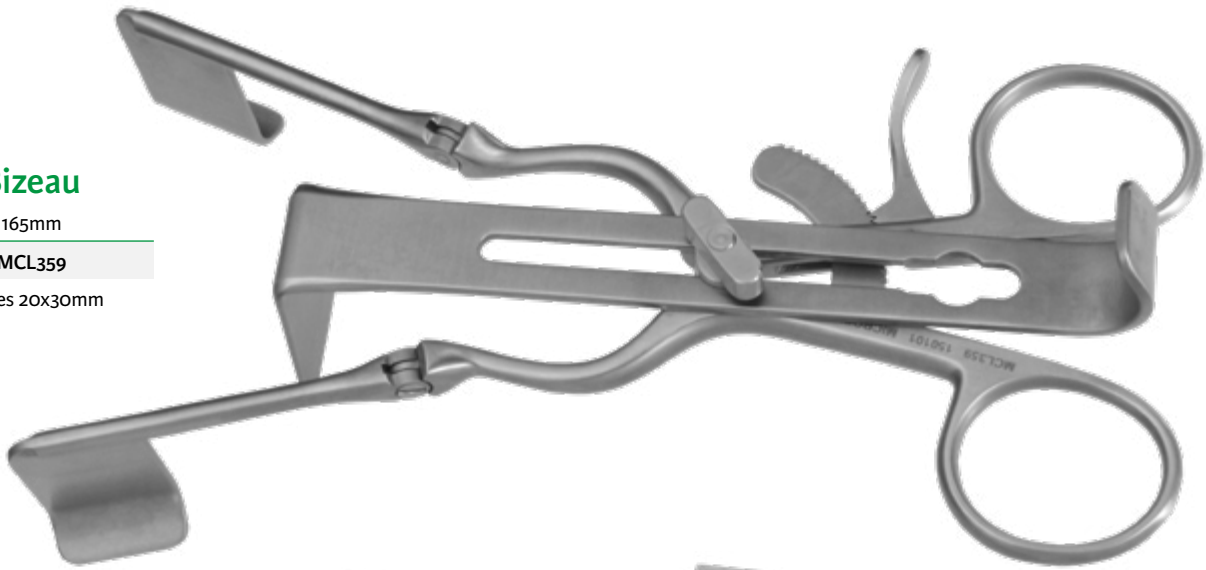

Weitlaner-Beckmann

165mm

7781



Malleable

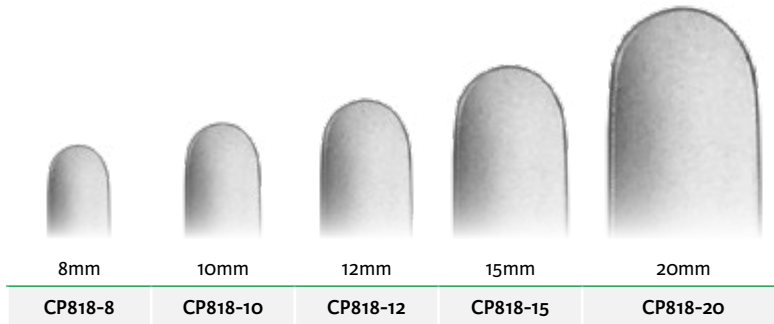

Malleable



Dautrey



Dautrey



Blade retractor
10/15mm - 160mm

7773

210mm

CP818-8

140mm

CP984

140mm

CP984-1

Scale 2/3



200mm

CEV418

Pack 2



Descottes

200mm

CEV417

Pack 2

Mosnier

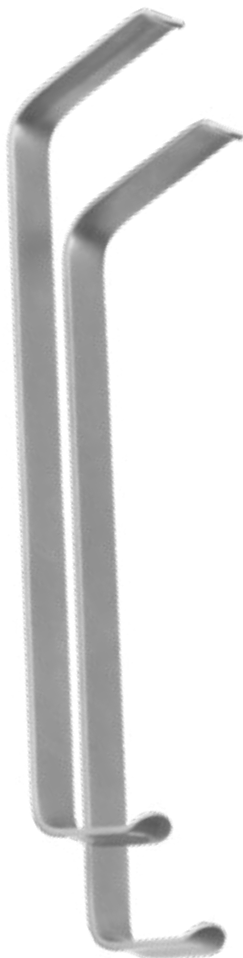

160mm

CEV419

Pack 2

Pessey



180mm

CP335P

Leroux-Robert



160mm

7923

Scale 3/4

Streiff



CP16-1

105mm

CP16-1	CP16
curved blades	straight blades

Offret



100mm

CP353
Strong curvature



100mm

CP356

Joseph



CP354A

120mm

CP354A	CP354
curved blades	straight blades

Joseph



CP919A

110mm

CP919A	CP919
curved blades	straight blades

Fox



CP358A

110mm

CP358A	CP358
curved blades	straight blades



Kilner-jost

120mm
CP362
Curved

Boetcher



180mm
CP997
Curved

Brophy



CP367-1

150mm
CP367-1 CP367
Curved Straight

Joseph



CP355A

150mm
CP355A CP355
Curved Straight

Scale 3/4

Shea



120mm

CP637

curved blades

Bregeat



110mm

CP363

curved blades

Stevens



110mm

CP922A

curved tenotomy scissors

Stevens



110mm

CP922

straight blades

Stevens



115mm

CP922B

curved tenotomy scissors

Reynolds

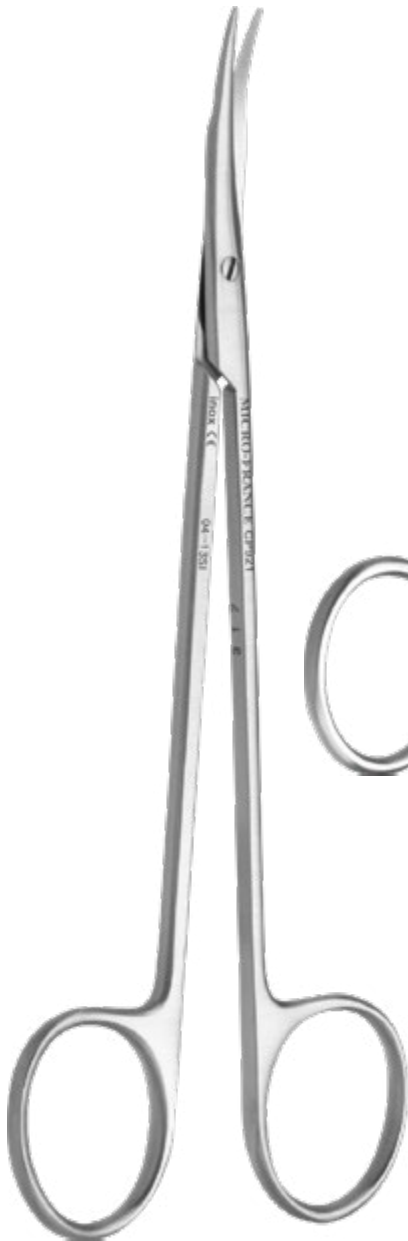

160mm

CP921

Ragnell

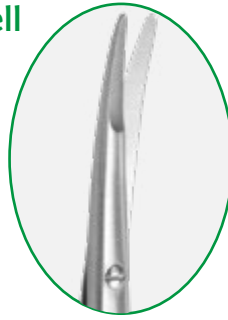

150mm

CP616-15



130mm

CP616-13

Joseph



150mm

CP355C

Léger



150mm

CP365

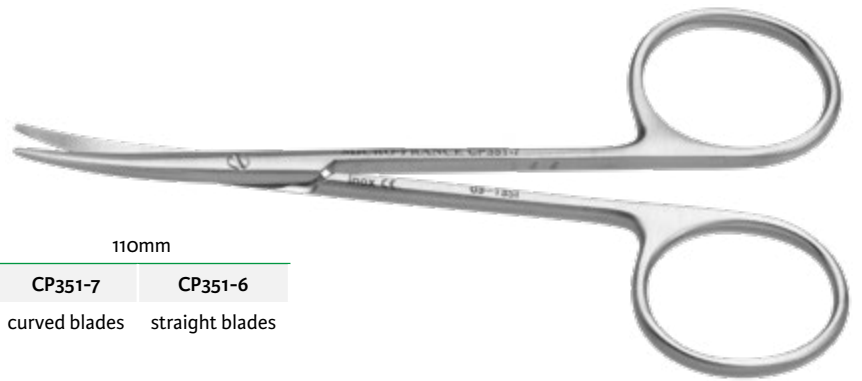

110mm

CP351-7	CP351-6
curved blades	straight blades

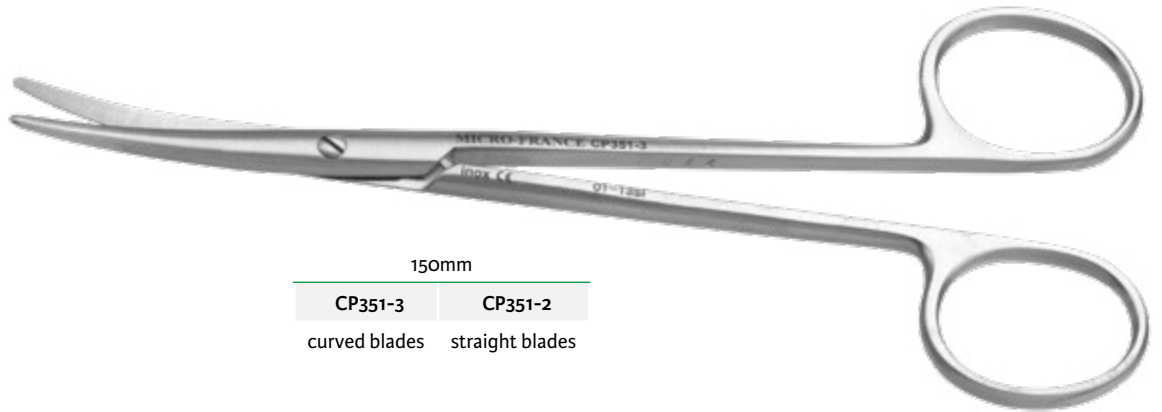

150mm

CP351-3	CP351-2
curved blades	straight blades

Delicate blades

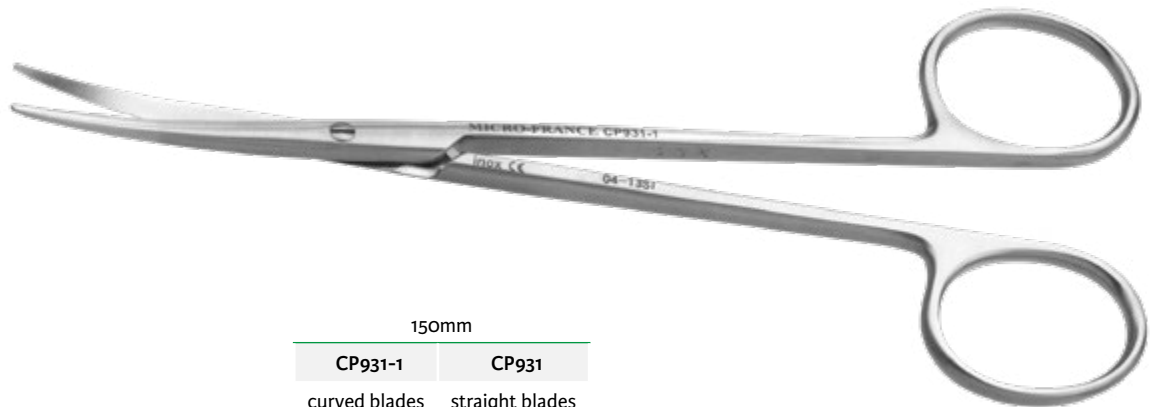

150mm

CP931-1	CP931
curved blades	straight blades



CP351-5

Curved standard	
CP351-5	CP351-1
200mm	180mm



CP931-5

Curved, delicate blades	
CP931-5	CP931-3
200mm	180mm



170mm
CP352-2
straight blades



150mm
CP352
straight blades



170mm
CP352-3
curved blades



150mm
CP352-1
curved blades

Dissecting forceps 110mm

Castroviejo



CP938-1

Horizontal 1x2 teeth and platform

Castroviejo



CP37

Oblique 1x2 teeth and platform



CP332

Serrated jaws 1.4mm

Dissecting forceps 120mm



serrated jaws

CP414

Jaws 1mm



7831A-12

Jaws 1.5mm



CP406

1x2 teeth - Jaws 1mm



Jaws with teeth

7833A-12

1x2 teeth - Jaws 1.5mm



CP400-1

5x5 griffes

150mm

Adson



- CP604-15 serrated jaws 1.5mm
- CP605-15 1x2 teeth 1.5mm jaws

Adson-Brown



- CP606-15 7x7 teeth

120mm



Adson-Tubiana

Jaws 1mm

M832
serrated



Adson

Jaws 1.5mm

CP604
serrated



Jaws 1.5mm

CP606A
tungsten serrated



Adson-Brown

Jaws 7x7 teeth

CP606

Mac-Indoe

140mm



CP934
Oblique
1x2 teeth
and
serrated
platform

CP934-1
Serrated
jaws

Debakey

Barraya

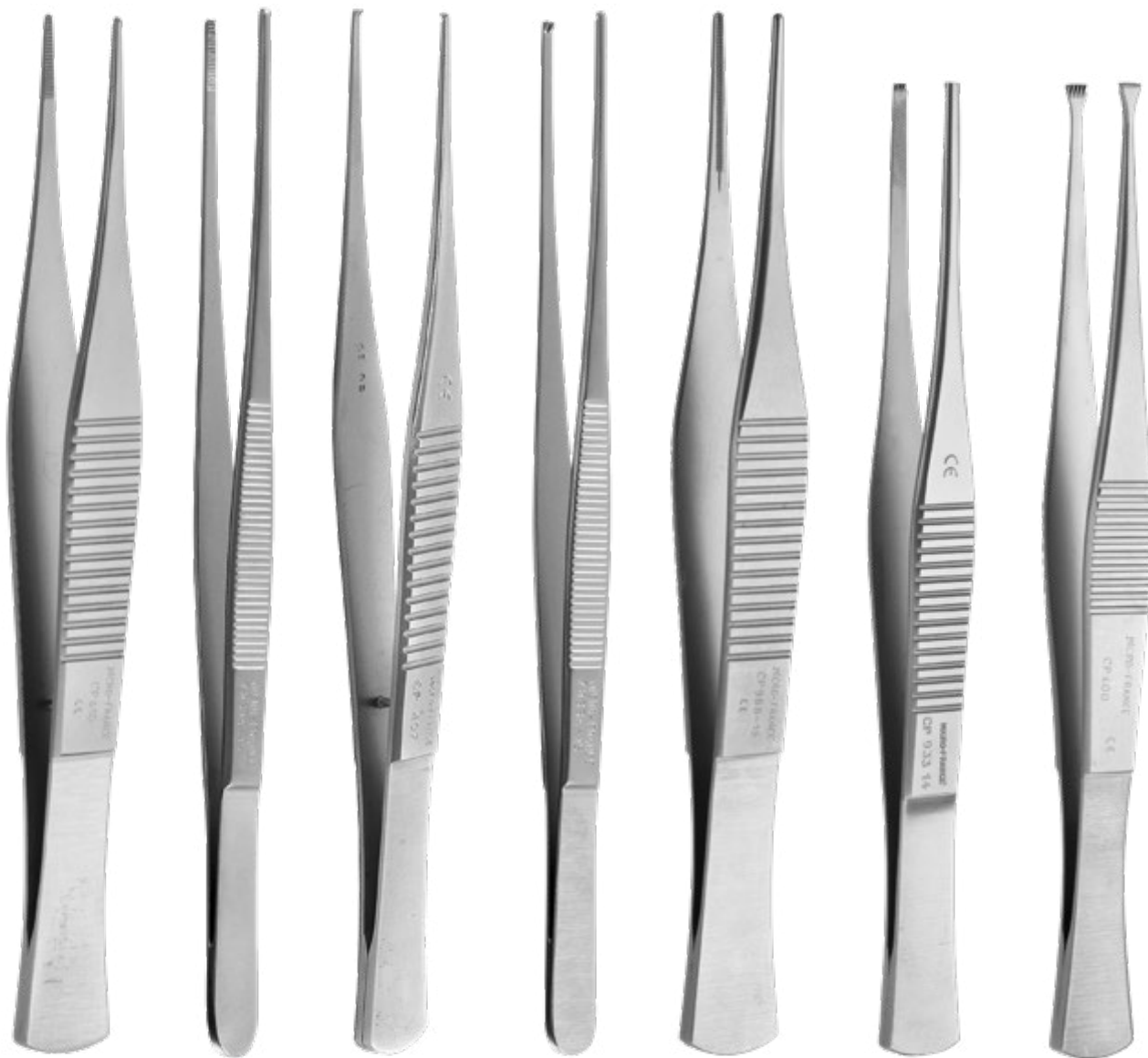

150mm

140mm

CP415	7831A-15	CP407	7833A-15	CP988-15	CP933-14	CP400
serrated jaws 1mm	serrated jaws 1.5mm	1x2 teeth jaws 1mm	1x2 teeth jaws 1.5mm	serrated jaws 1.5mm	3x4 teeth & serrated platform	5x5 teeth

Précelle



150mm

CP345

serrated
angled jaws

Barraya



160mm

CP933-16

3x4 teeth and
serrated platform

Claoué



160mm

CP401

5x6 teeth

Mac-Indoe



170mm

CP936

1x2 teeth and
serrated platform

Debaquey

Barraya



1.5mm
7831A-18



1.5mm
CP988-18



1mm
CP409
1x2



1.5mm
7833A-18
1x2



1.5mm
CP933-18
3x4 teeth and
serrated platform



6x6
CP400-2

Debakey



200mm

7832

1mm
serrated



210mm

7834

1mm
1x2 teeth



2mm

7831A-20



1,5mm

CP988-20



2mm

7833A-20

1x2 teeth

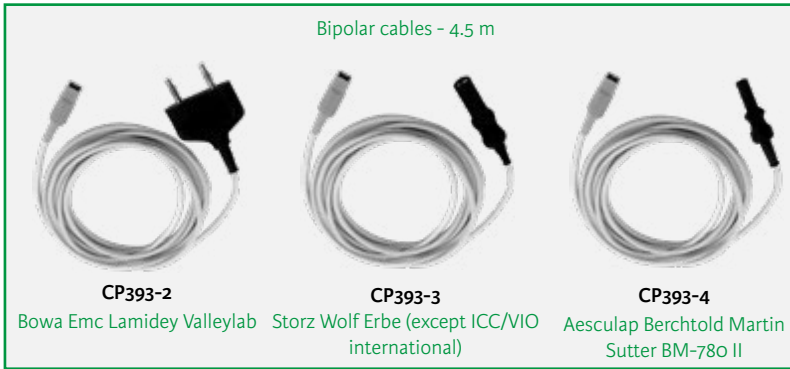

Magnan

Adson

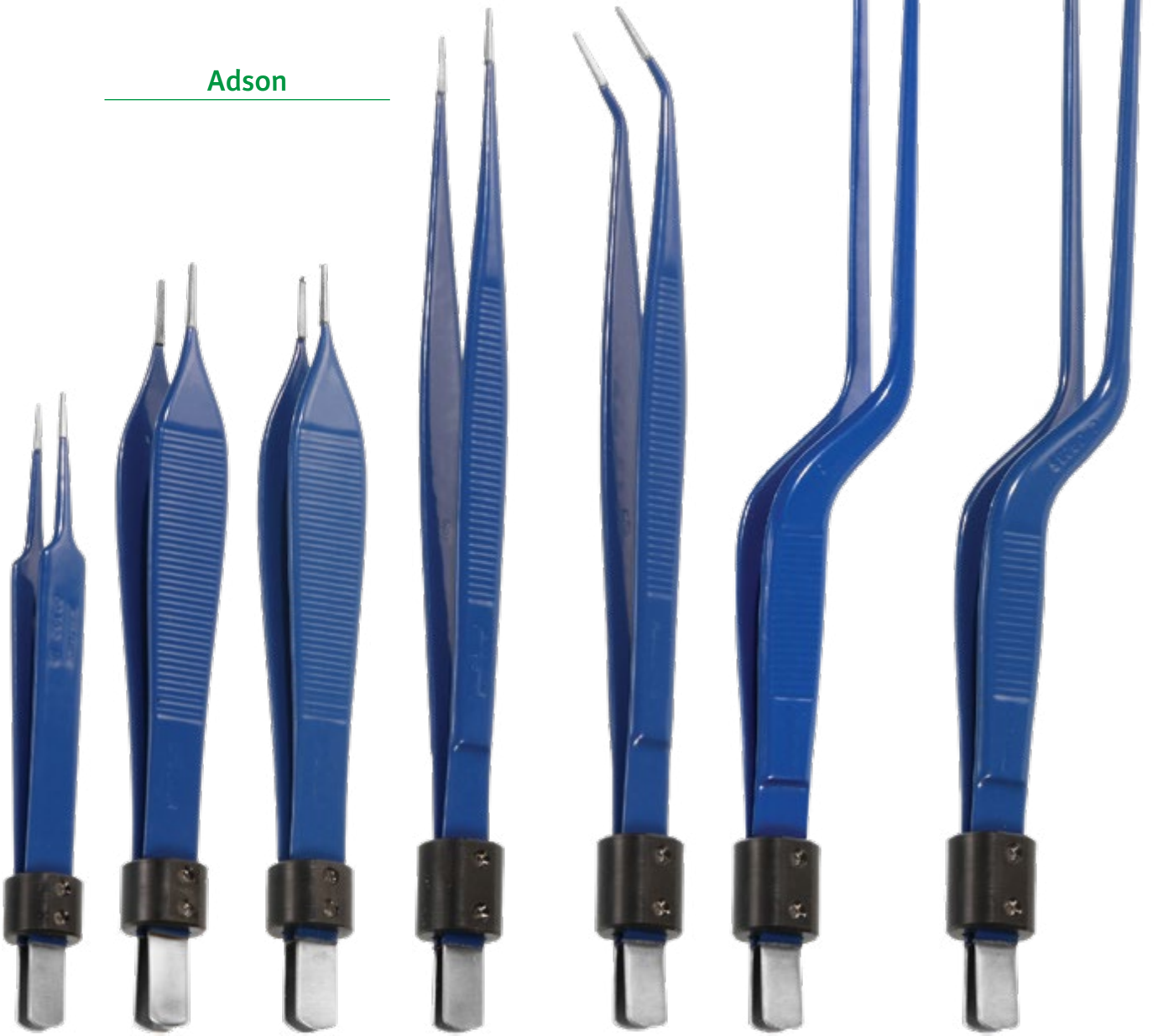

110mm		120mm		160mm		200mm	
CP392-1R	CP604BR	CP605BR	CP392-2R	CP392-8R	CP392BI	CP392BS	
smooth jaws 1x8mm	serrated jaws 1.5mm	1x2 teeth 1.5mm	smooth jaws 1x8mm	smooth jaws 1x8mm	smooth jaws 0.5x5mm	smooth jaws 0.5x5mm	



Bipolar cables - 4.5 m



CP393-2
Bowa Emc Lamidey Valleylab



CP393-3
Storz Wolf Erbe
(except ICC/VIO international)



CP393-4
Aesculap Berchtold Martin
Sutter BM-780 II

CP392-3R Straight smooth jaws 1x8mm	CP392-10R Angled tip smooth jaws 1x8mm	CP392-5R Bayonet smooth jaws 1x8mm	CP392-9R Bayonet Angled down jaws 1x8mm
--------------------------------------------------	-----------------------------------------------------	-------------------------------------------------	------------------------------------------------------

Scale 2/3

Dousset



Belghiti

Soubrane

Gayet

Partenski



300mm	230mm	230mm	230mm	240mm	210mm
CEV392D30	CEV392D20	CEV392P20	CEV392S20	CEV392G24	CEV392R15
Jaws 3mm	Jaws 2mm	Jaws 2mm	Jaws 2mm	Jaws 5x15mm	Jaws 4x10mm

Scale 2/3

Working length - «L»

Chambon



290mm L 260mm

CP390L26

smooth jaws 1x8mm



CP390-3

smooth jaws 1x8mm



230mm L 200mm

CP390-5

angled jaws 1x8mm



CP390-7

smooth jaws 1x8mm

Monopolar cables 3.5m



CP391E

Erbe ACC ICC/VIO
Storz Wolf



CP391M

Aesculap Berchtold Martin
Erbe T Serie Lamidey
Sutter BM-780 II



CP391V

Bowa Bovie Conmed Valleylab



Adson



110mm

CP390-1

smooth jaws 1x8mm



120mm

CP604M

serrated jaws 1.5mm



CP605M

1x2 teeth 1.5mm



160mm

CP390-2

smooth jaws 1x8mm



CP390-8

1x2 teeth 1x8mm

Halsey

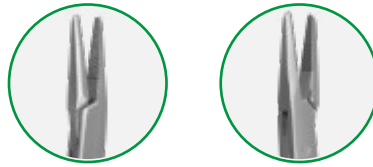

130mm

703T	704T
serrated jaws	smooth jaws



703T

Crile-Wood Mayo-Hégar

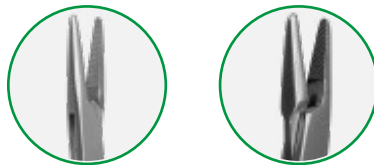

150mm

702T	714T
------	------



702T

Becker

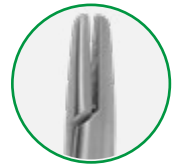

130mm

CP1107
diamond jaws

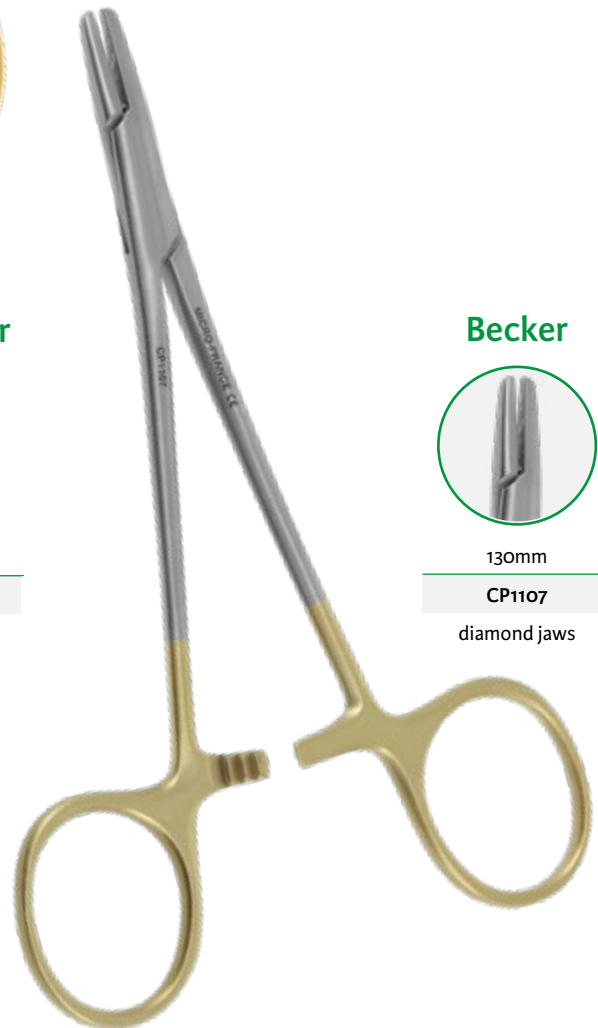

Scale 2/3

Crile-Wood

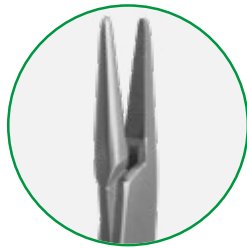

200mm

720T



Crile-Wood

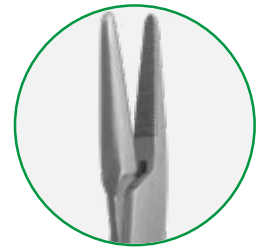

180mm

701T



Stratte



210mm

7945T



Halsted

120mm - with teeth

P761-7	P761-8
--------	--------

Straight	Curved
----------	--------



P761-7

Leriche

140mm - without teeth

7867-1	7867-2
--------	--------

Straight	Curved
----------	--------

140mm - with teeth

7867-3	7867-4
--------	--------

Straight	Curved
----------	--------



7867-1

Kelly

without teeth

140mm	160mm
P762-2	P762-4
Curved	Curved



P762-2

Kocher

140mm	160mm	180mm
Straight without teeth		
P764-1	P764-5	-
Straight with teeth		
P764-3	P764-7	P764-11



P764-3



Martel

130mm

P763

Forceps with teeth
'T' tip



Terrier

130mm

P769

Haemostatic forceps
serrated jaws



Péan

140mm 160mm

P765-14

P765-16

Haemostatic forceps
serrated jaws

P765-14

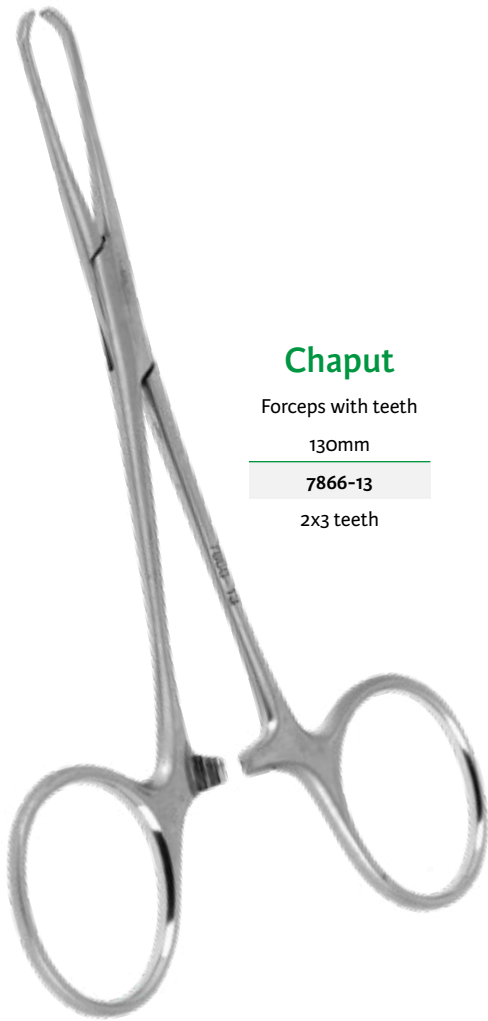

Chaput

Forceps with teeth

130mm

7866-13

2x3 teeth



Ombredanne

with teeth
130mm

P771

Haemostatic
fenestrated forceps
160mm

P770

Heart serrated jaws

Blunt eyes suction tube

Scale 1/4

Working length - «L»

	2mm	2.5mm	3mm	3.5mm	4mm
L 450mm	MCL920L45	MCL925L45	MCL930L45	MCL935L45	MCL940L45
L 550mm	MCL920L55	MCL925L55	MCL930L55	MCL935L55	MCL940L55

MCL940L45

Forceps

Forceps	Crocodile forceps	Cup forceps Ø 4mm	Cup forceps up opening 3.5x10mm	Cup forceps upward Ø 4mm
L 400mm	7844T3L40	7844T5L40	7844T6L40	7844T7L40
L 450mm	7844T3L45	7844T5L45	7844T6L45	7844T7L45
L 500mm	7844T3L50	7844T5L50	7844T6L50	7844T7L50
L 550mm	7844T3L55	7844T5L55	7844T6L55	7844T7L55
L 600mm	7844T3L60	7844T5L60	7844T6L60	7844T7L60

7844T5L40

Esophagoscope

MCL320 Esophagoscope without handle - fiber
12x16mm

Handle MCL112H

Fiber MCL320F

L 300mm

MCL330 Esophagoscope without handle - fiber
12x16mm

Handle MCL112H

Fiber MCL330F

L 500mm

Container
7874MF-61
640x189x95mm - L 610x180x80mm

Scale 1/3

Scale 1/4

Working length - «L»

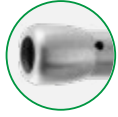

Blunt eyes suction tube

	2mm	2.5mm	3mm	3.5mm	4mm	
L 250mm	MCL920L25	MCL925L25	MCL930L25	MCL935L25	MCL940L25	MCL930L25
L 350mm	MCL920L35	MCL925L35	MCL930L35	MCL935L35	MCL940L35	

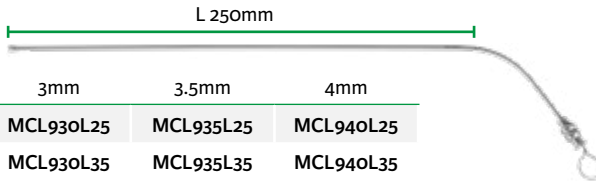

Forceps

Forceps	Crocodile forceps	Cup forceps Ø 4mm	Cup forceps up opening 3.5x10mm	Cup forceps upward Ø 4mm	
L 200mm	7844T3L20	7844T5L20	7844T6L20	7844T74L20	7844T5L25
L 250mm	7844T3L25	7844T5L25	7844T6L25	7844T74L25	
L 300mm	7844T3L30	7844T5L30	7844T6L30	7844T74L30	
L 350mm	7844T3L35	7844T5L35	7844T6L35	7844T74L35	

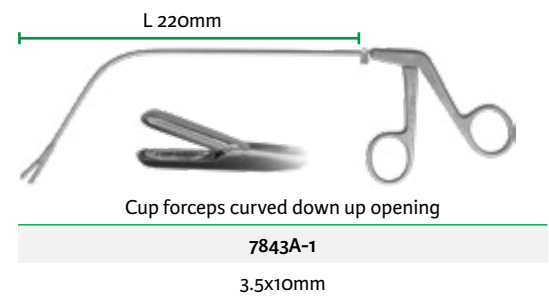
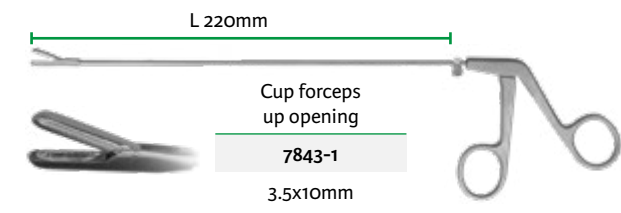

Hypopharyngoscope

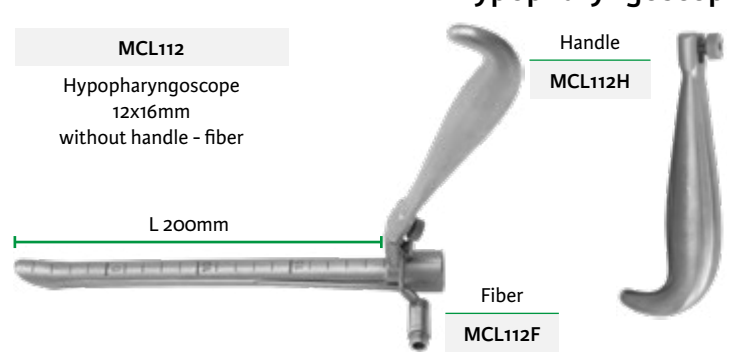
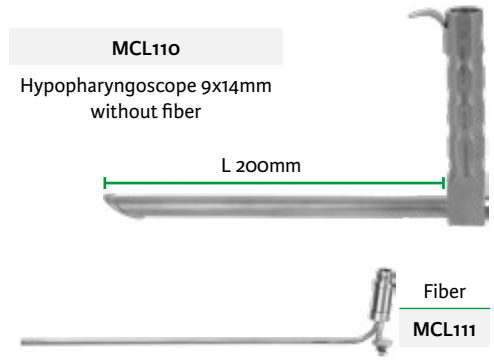

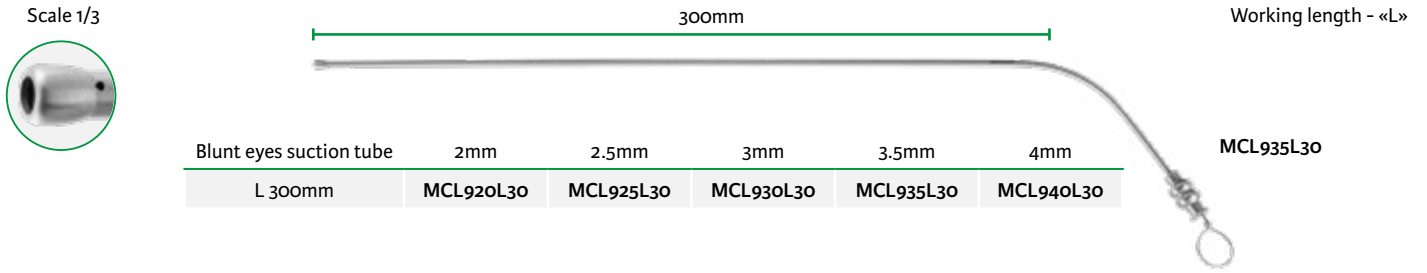

Lacau diverticuloscope

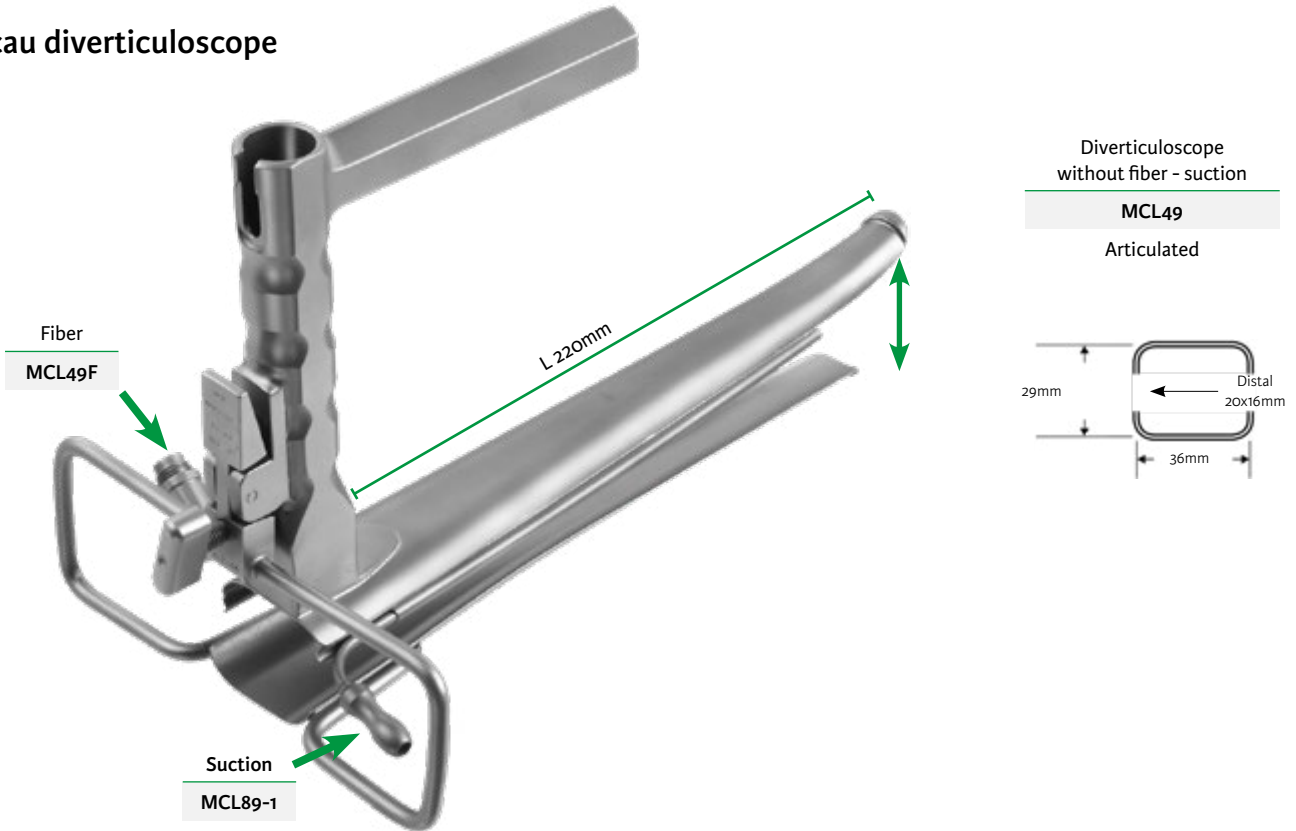

Reyt diverticuloscope

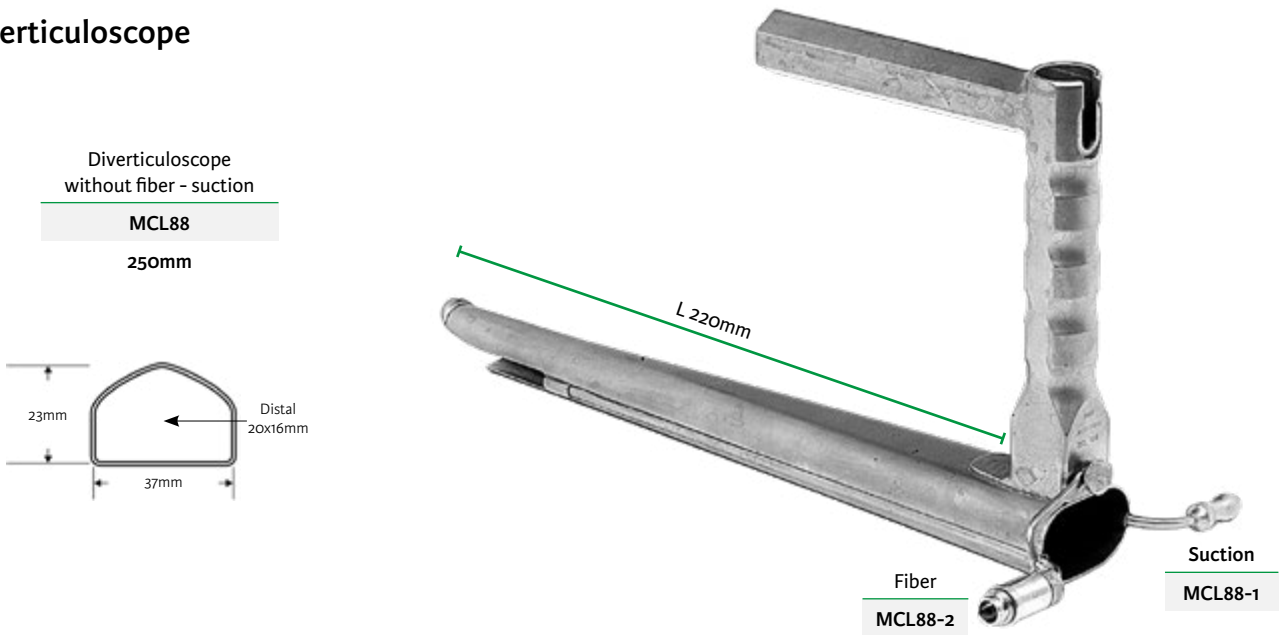

Picture for information, without scale

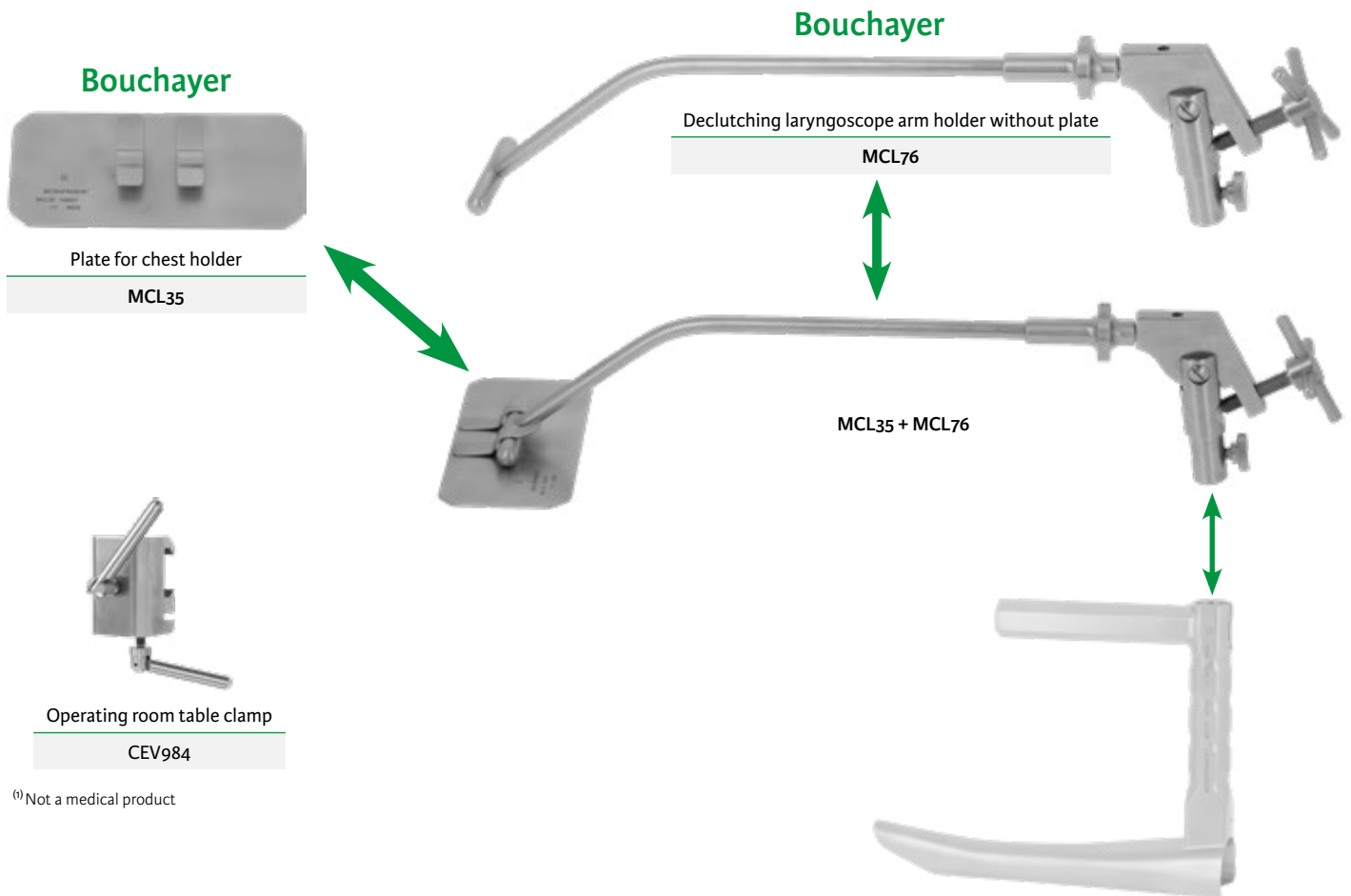

⁽¹⁾ Not a medical product

Cold light



Adapters for instruments and endoscopes

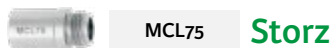

Adapters	generator side	instrument side
Wolf	MCL170⁽¹⁾	MCL171⁽¹⁾
Storz	MCL173⁽¹⁾	MCL174⁽¹⁾
Olympus	MCL197⁽¹⁾	

⁽¹⁾ Distributed by Integra MicroFrance SAS (France) - For corresponding manufacturer part numbers, see table in annex

Scale 1/3

Working length - «L»

Lescanne

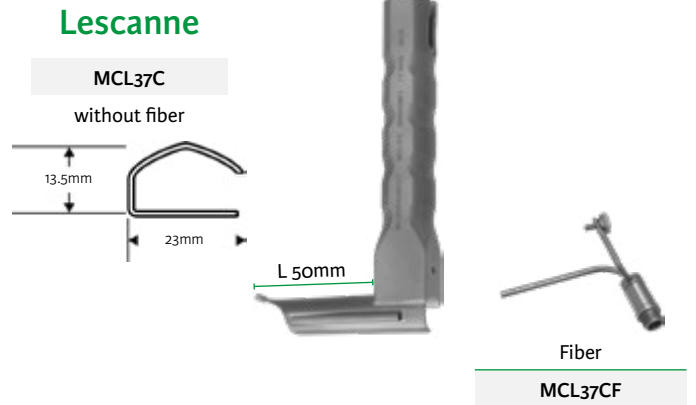
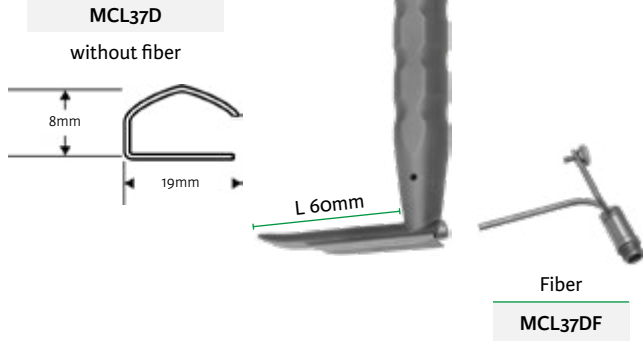

Garabédian

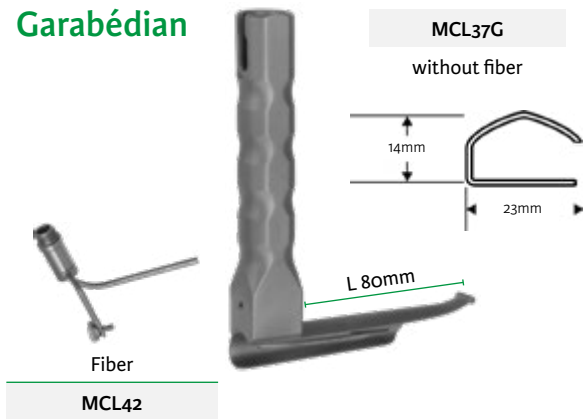

Garcin

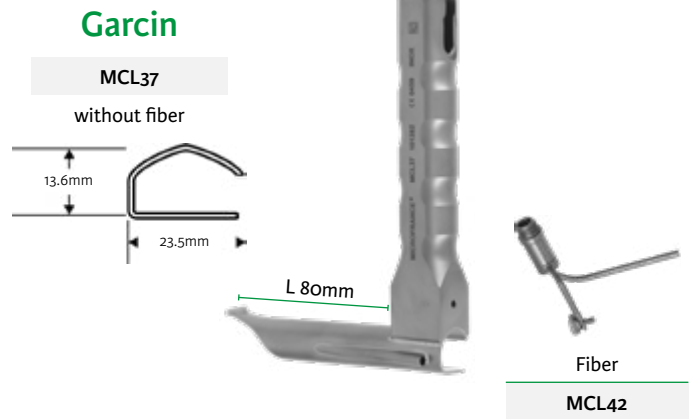

Legent

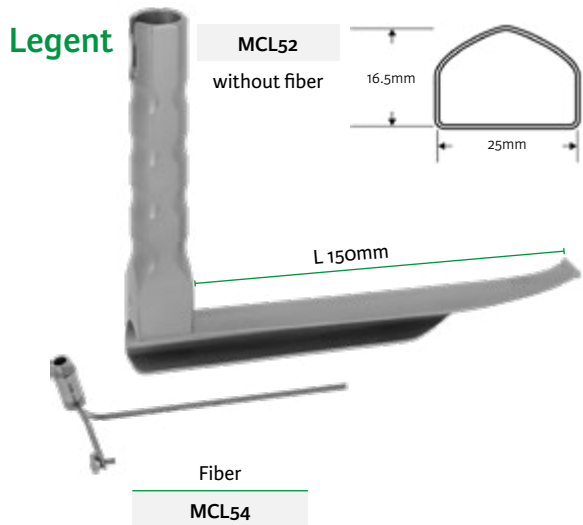

Legent

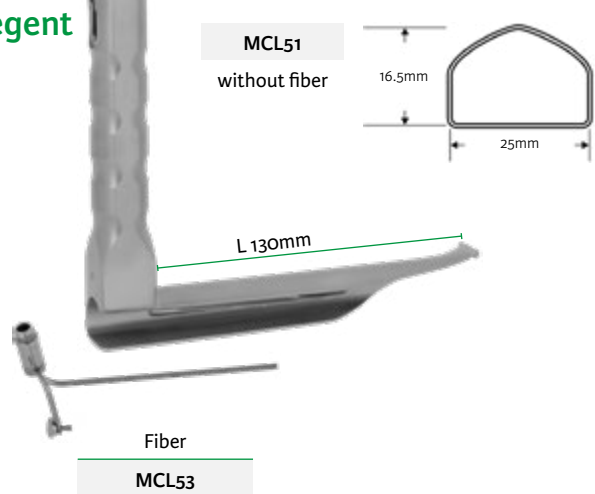

Scale 1/3

Working length - «L»

Bouchayer

MCL79
without fiber

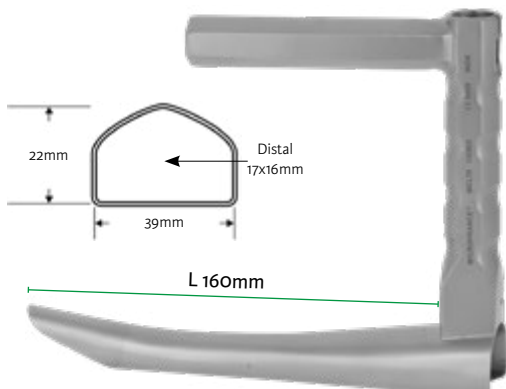

Fiber

MCL78

Bouchayer

MCL77
without fiber

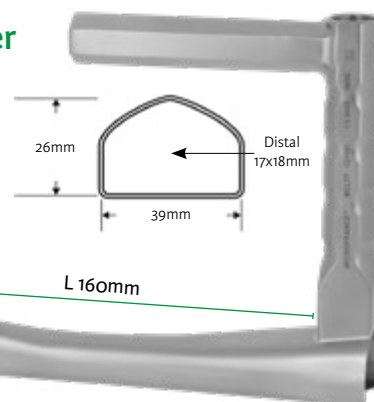

Pignat

MCL64
without fiber
small size

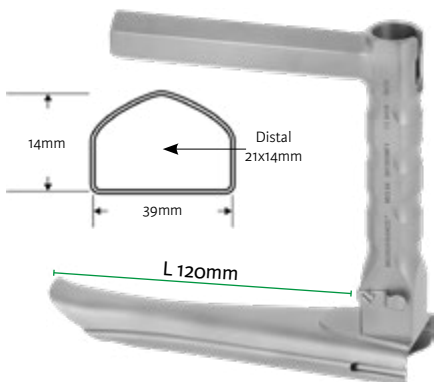

Fiber

MCL64F

Pignat

MCL63
without fiber
large size



Fiber

MCL63F

Scale 1/3

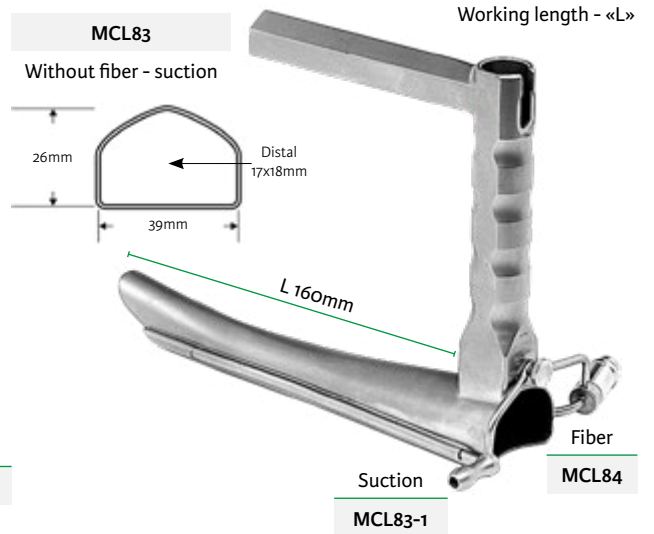
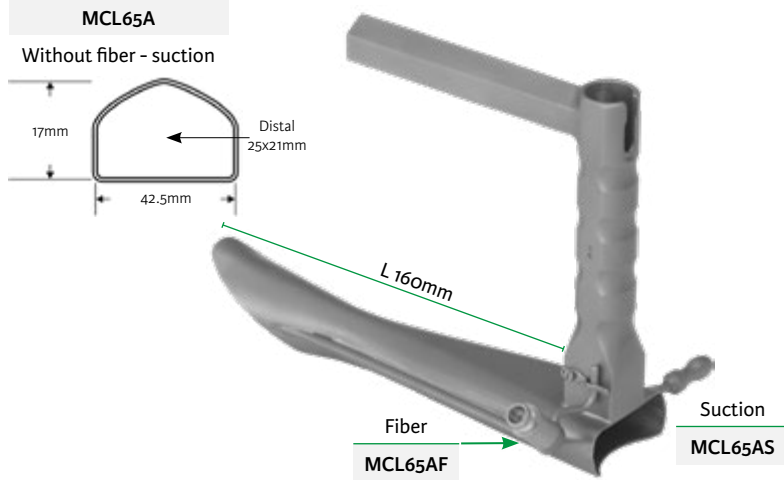

Abitbol

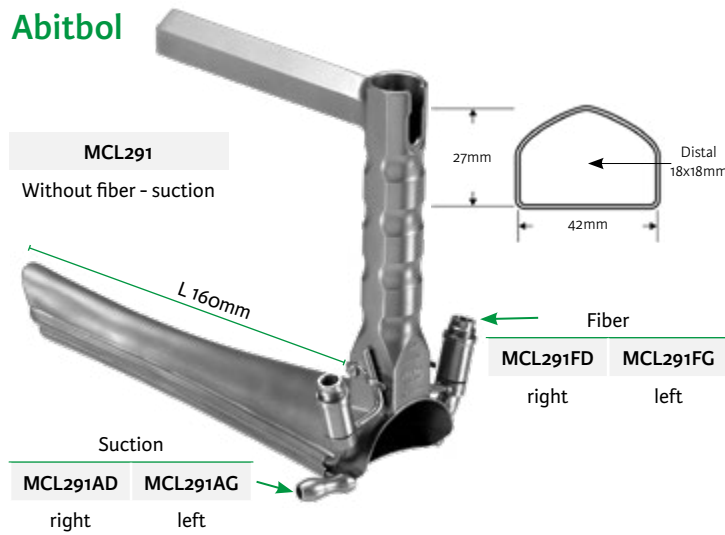

Brasnu

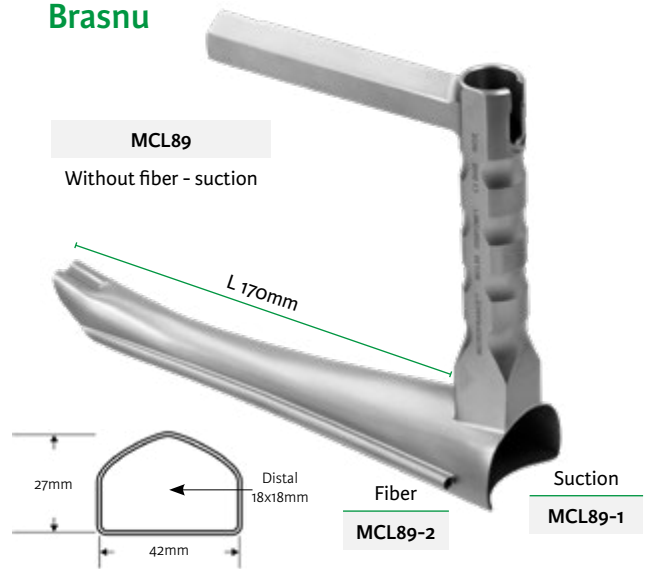

Abitbol

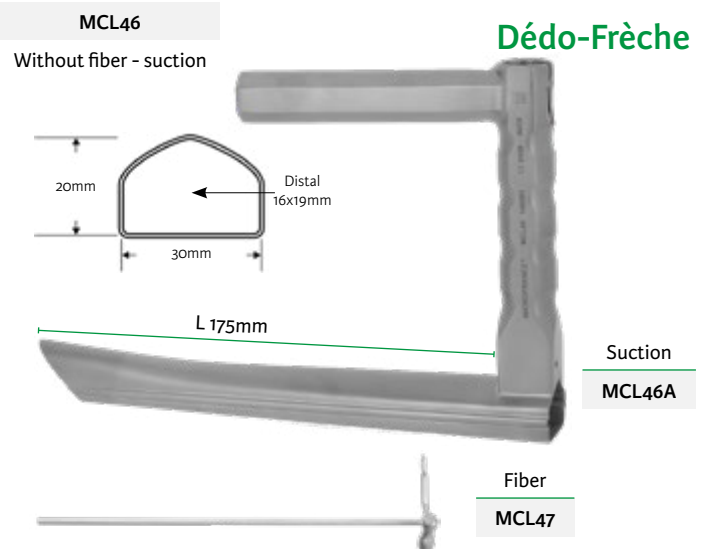
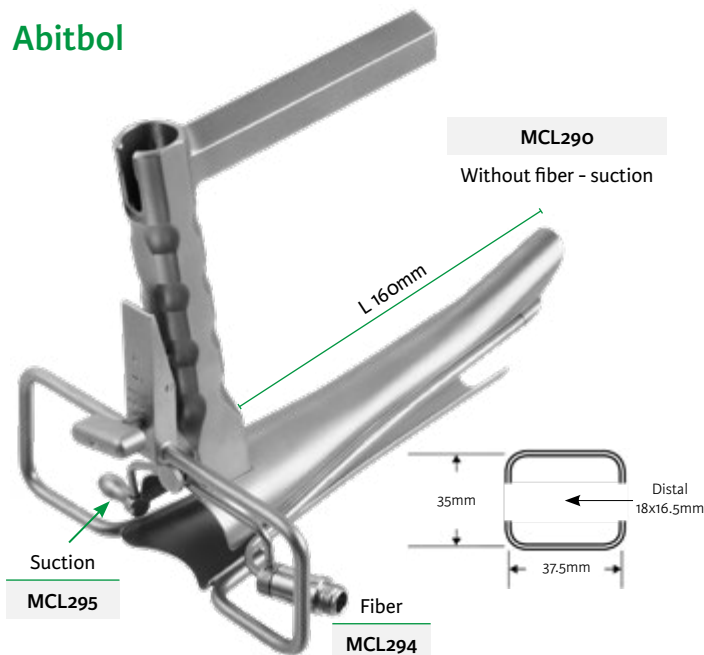

Scale 1/3

Sataloff

Working length - «L»

MCL120

Pediatric size
With fiber and suction

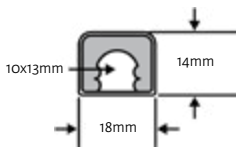

MCL121

Medium male size
With fiber and suction

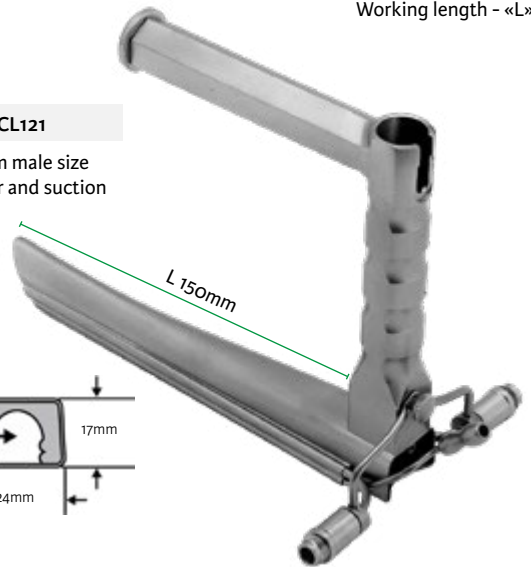
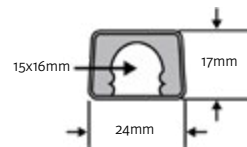

MCL122

Adult size
With fiber and suction

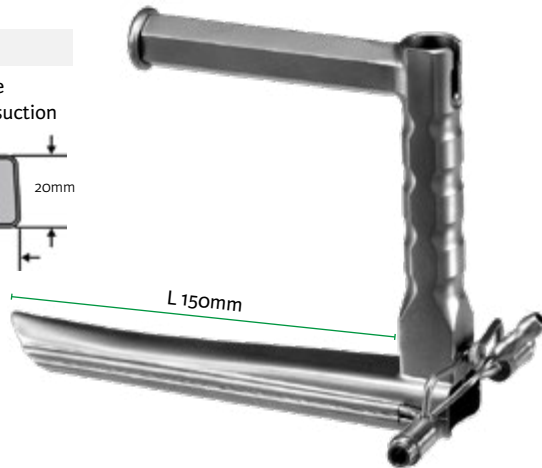
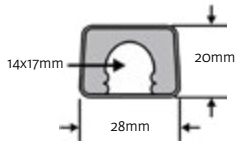

MCL123

Medium female size
With fiber and suction

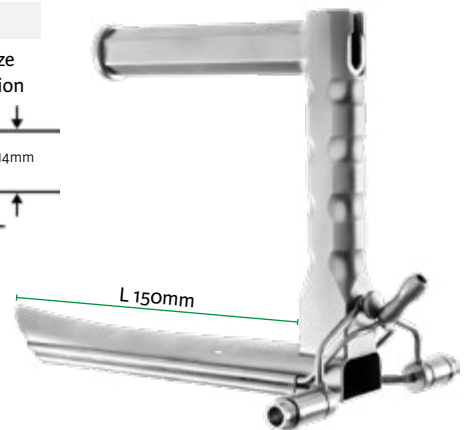
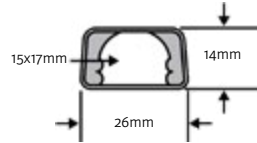

MCL124

«Vallecula»
With fiber and suction

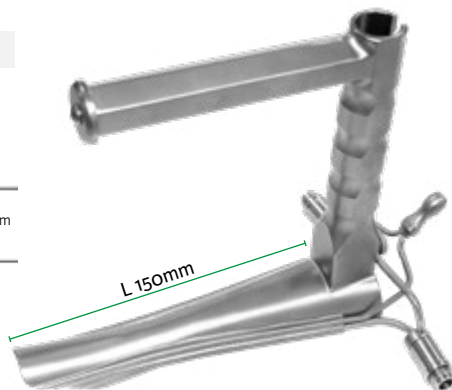
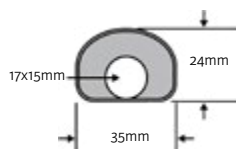

MCL125

With fiber and suction

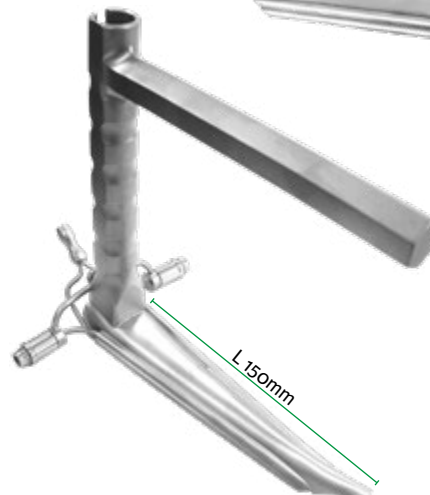
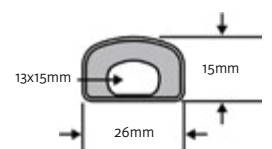

Complete laryngoscope	Right light fiber	Left light fiber	Dual suction tube
MCL120	MCLS120-2	MCLS120-1	MCLS120-3
MCL121	MCLS121-2	MCLS121-1	MCLS121-3
MCL122	MCLS122-2	MCLS122-1	MCLS122-3
MCL123	MCLS123-2	MCLS123-1	MCLS1233
MCL124	MCL124FR	MCL124FL	MCL124ST
MCL125	MCL125FR	MCL125FL	MCL125ST

Suction tube

Bouchayer



MCL10
Ø 2.5mm

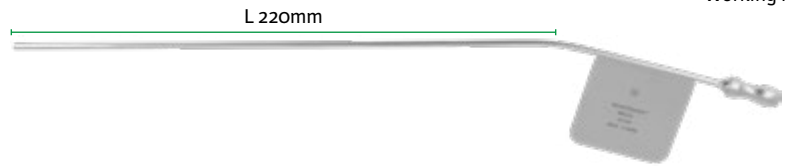

Blunt eyes suction tube

Brasnu

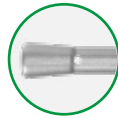

MCL100
Ø 2.5mm

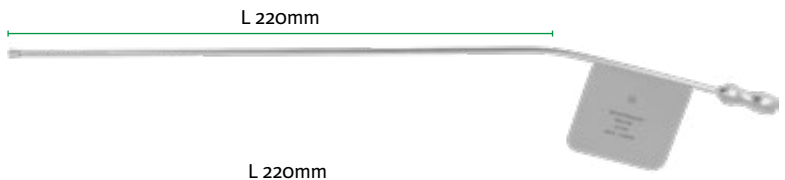

Garabédian



MCL100T20 MCL100T15
Ø 2mm Ø 1.5mm

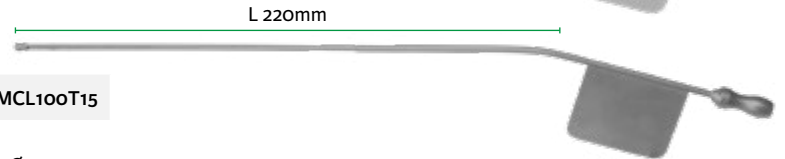

Insulated suction tube

Abitbol



MCL210
Ø 2.5mm

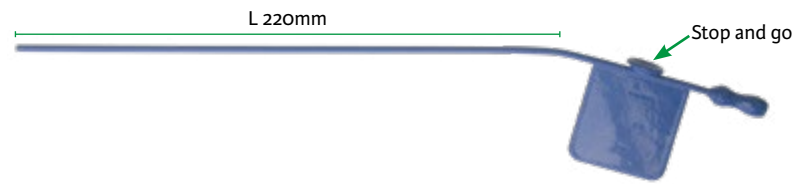

Dual suction tube

Huttenbrink

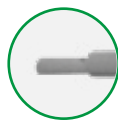

MCL103
Ø 2.5mm



French velvet eye suction tube

Sataloff



Micro suction tube
MCL-S16



Micro suction tube with retractor below
MCL-S17



Micro suction tube with retractor above
MCL-S17-1

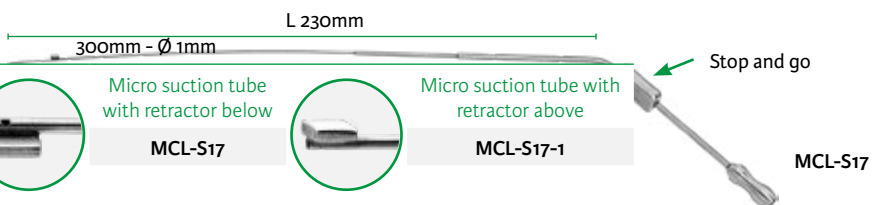

MCL-S17

Working length - «L»

Scale 1/3

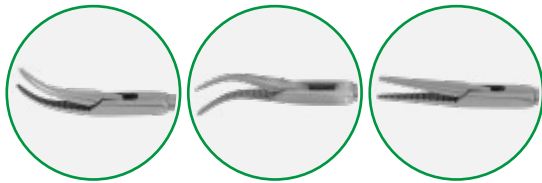

MCL18 curved right	MCL15 curved left	MCL25 straight
------------------------------	-----------------------------	--------------------------



Alligator forceps

MCL18

Bouchayer

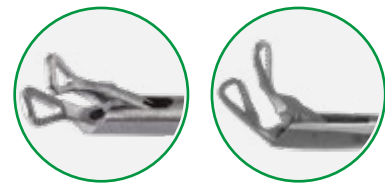

MCL19 left	MCL19BIS right
----------------------	--------------------------



Heart-shaped forceps 45°

MCL19

Bouchayer

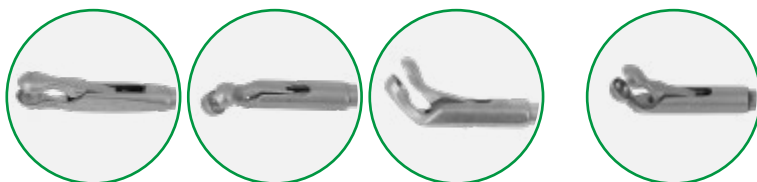

MCL12 straight	MCL29 curved left 45°	MCL30 curved right 45°	MCL33 upward
--------------------------	------------------------------------	-------------------------------------	------------------------

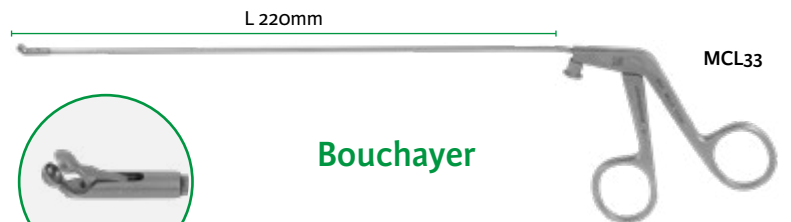

Cup forceps Ø 2mm

MCL33

Bouchayer

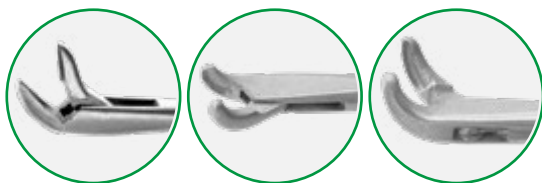

MCL67 upward	MCL68 curved left	MCL69 curved right
------------------------	-----------------------------	------------------------------

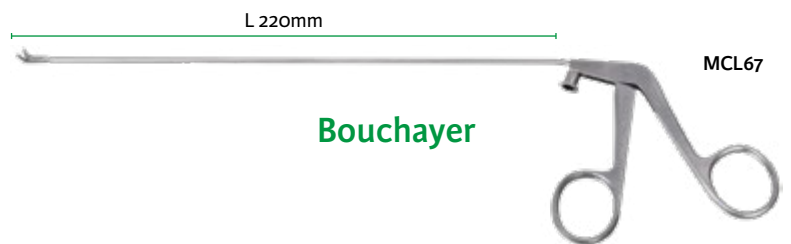

Oval cup forceps

MCL67

Bouchayer

Scale 1/2

Micro scissors

Bouchayer

L 220mm



MCL11
straight



MCL31
angled up - 45°



MCL16
right curved



MCL17
left curved



MCL11

Lancet knife, elevator

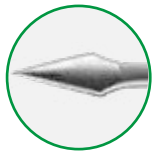

Lancet knife

MCL57



Angled elevator 90°

MCL81BL
left



MCL81BR
right



Elevator

MCL56BL
curved left



MCL56BR
curved right

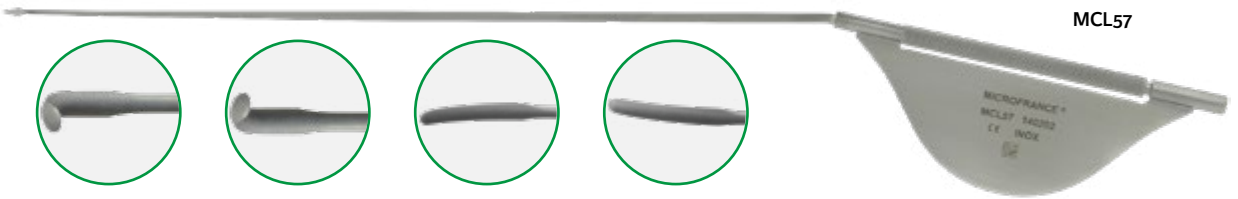

MCL57

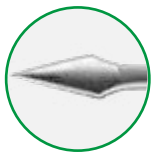

Lancet knife handle and 3 blades

MCL93

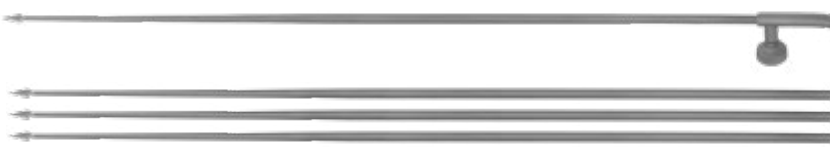

knife blades (pk 3) for MCL93

MCL93-2



MCL93

Micro needle-holder



MCL94

straight serrated jaws
1.5x5mm



Micro retractor forceps



MCL82



Scale 1/2

Elevator

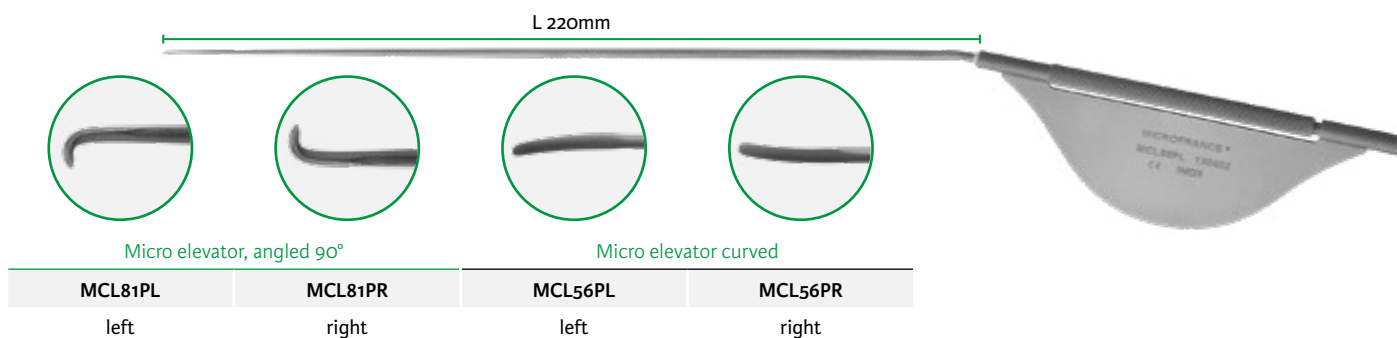

Stylet handle and needle-holder insert

Scale 1/3

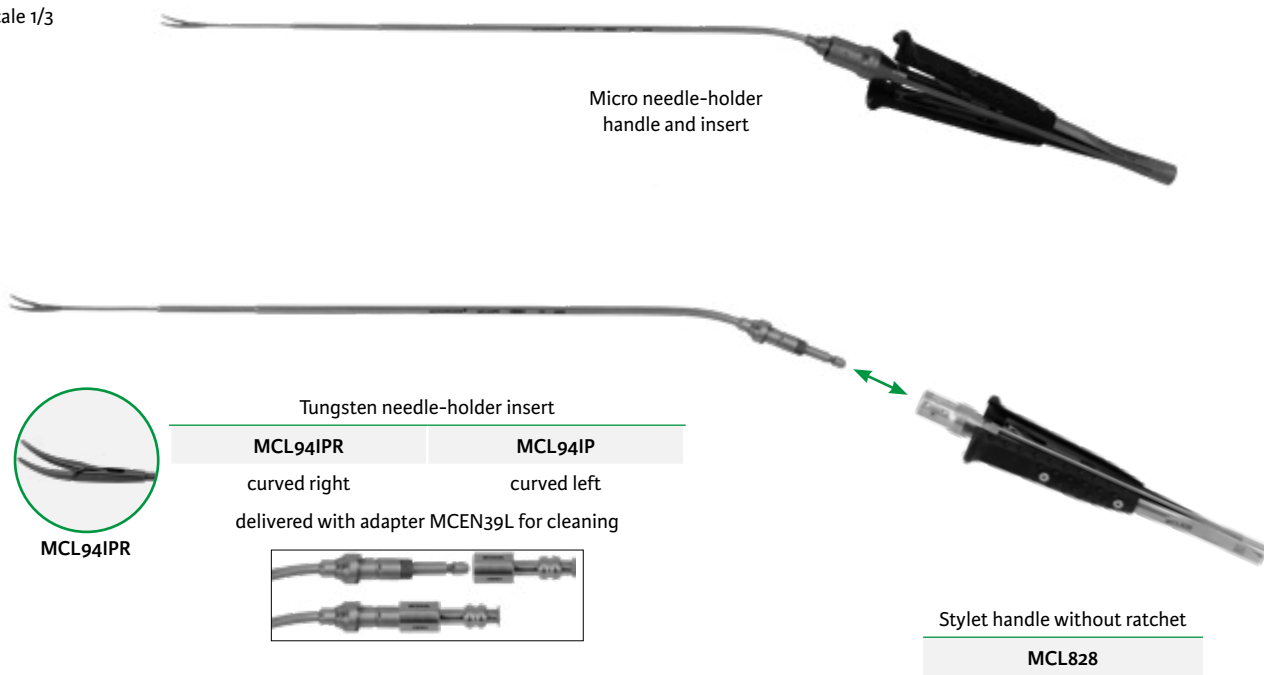

Insulated suction tube with finger control

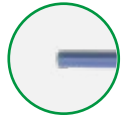

MCL210
Ø 2.5mm

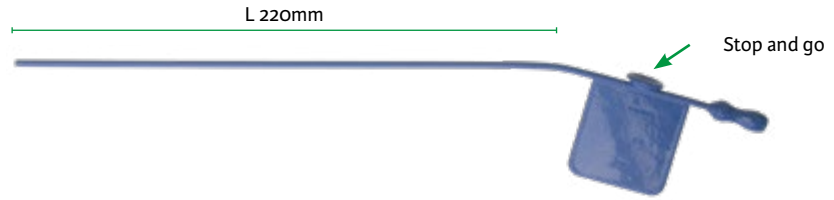

Monopolar fenestrated forceps



MCL205
3x9mm jaws



Heart-shaped forceps, monopolar



MCL219
right curved



MCL219-1
left curved

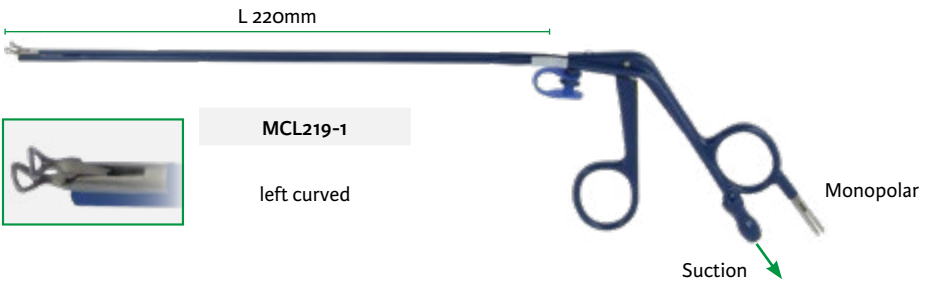

Alligator forceps, monopolar



MCL241
right curved



MCL241-1
left curved

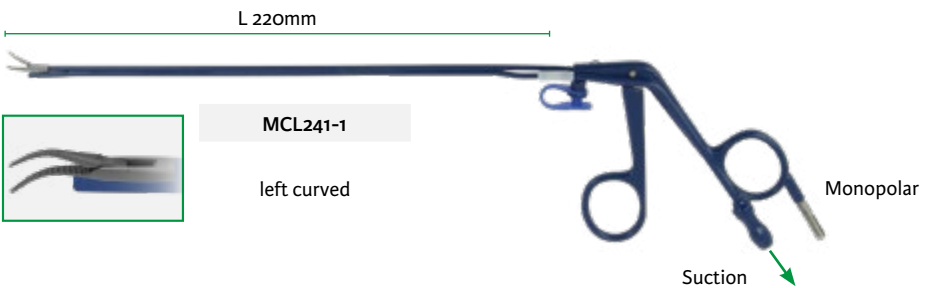

Monopolar cables - 3.5 m



CP391E

Erbe ACC ICC/VIO Storz Wolf



CP391M

Aesculap Berchtold Lamidey Martin Erbe T Serie Sutter BM-780 II



CP391V

Bowa Bovie Conmed Valleylab

Scale 1/2 Working length - «L»

Knife blade sterile, Single use, Pack 25
Scale 2/3



SM63^(D)

SM64^(D)

SM65^(D)



Laryngeal diastema - pediatrics

CP821E

Scalpel handle 170mm

Scalpel handle, knife blade

Garabédian

Scale 1/3

L 180mm

Micro pediatric needle-holder
handle and insert



Tungsten needle-holder insert



MCL94IG

delivered with adapter
MCEN39L for cleaning



MCEN39L

Luer-lock adapter for
tube insert cleaning port
Pack 3

Stylet handle with ratchet

MCL828C

Needle-holder

Garabédian

Scale 1/2

L 230mm

Needle-holder, tungsten jaws



MCL94G

1-piece

Cleaning
instrument

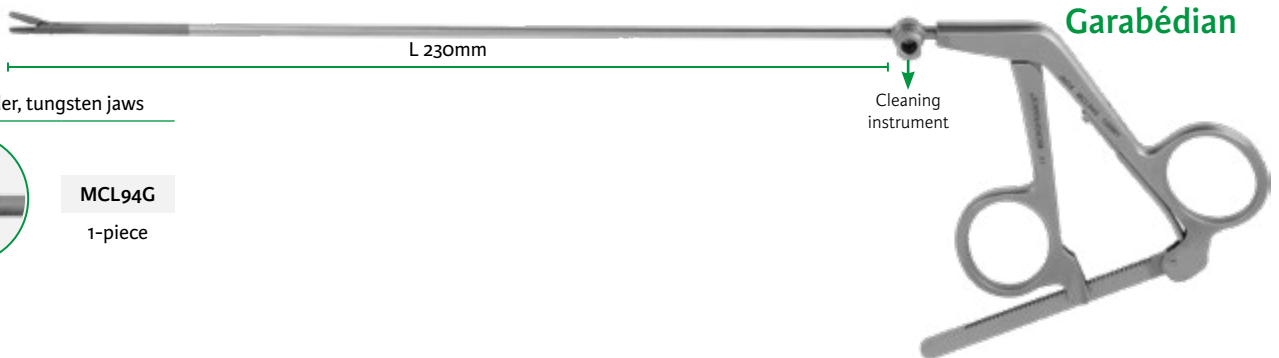

Garabédian

Scale 1/2

L 220mm

Oval knife, hook, retractor



MCL4

oval knife 3x4mm



MCL5

oval knife 45° 2mm



MCL7

blunt hook



MCL48

blunt retractor 7mm



Micro sickle knife

Scale 1/2

Micro sickle knife curved 10mm

L 220mm



MCL1BIS

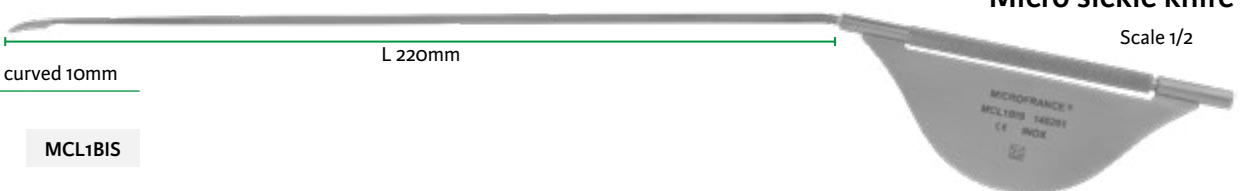

^(D) Distributed by Integra MicroFrance SAS (France) - For corresponding manufacturer part numbers, see table in annex

Parsons

Laryngeal sprinkler

L 200mm

Scale 1/2
Working length - «L»

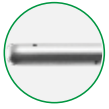

MCL98

Ø 1,5mm

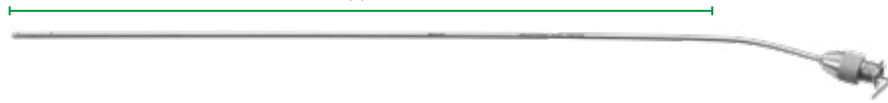

Bouchayer

Bayonet injection needle

L 210mm



MCL58

Ø 0,5mm



Woo

Scissors, 5mm blades

L 200mm



MCLW10

straight

MCLW11

up 45°

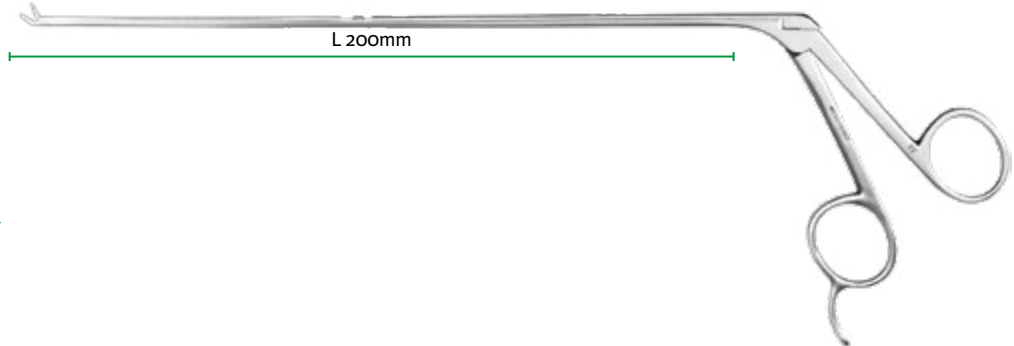

3734115

knife

L 250mm



Lowinger

Double probe

MCL101

Ø 2,5mm / 1mm
280mm

MCL102

Ø 2mm / 1mm
260mm

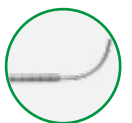

Scale 1/3

Working length - «L»

Monopolar instruments

Frèche

Electrode pick bayonet

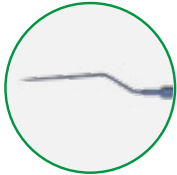

MCL59

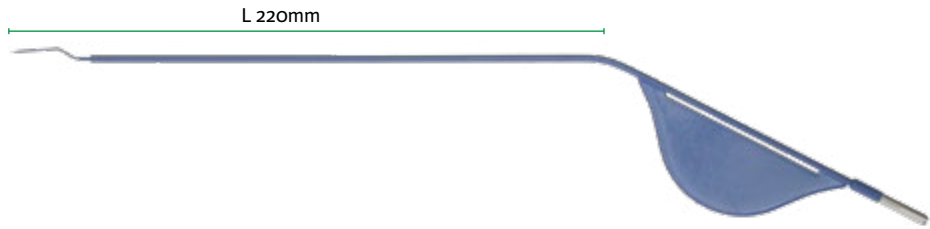

Suction tube with finger control

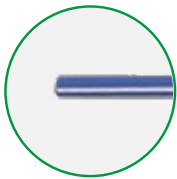

MCL62

Ø 2.5mm

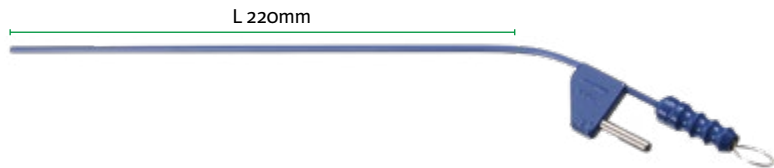

Monopolar cables - 3.5 m



CP391E

Erbe ACC ICC/VIO Storz Wolf



CP391M

Aesculap Berchtold Lamidey Martin Erbe T Serie Sutter BM-780 II



CP391V

Bowa Bovie Conmed Valleylab

Bipolar forceps

Micro forceps, straight jaws



MCL34



Delivered with box and tray

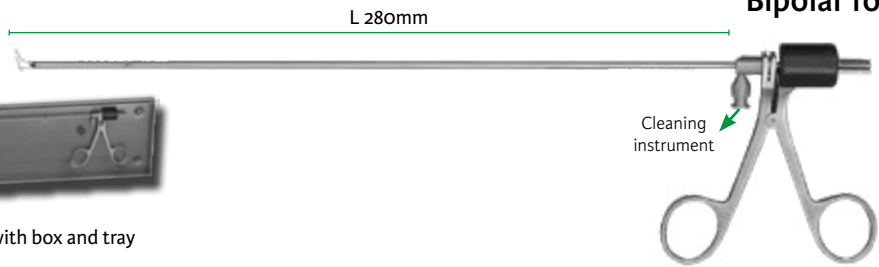

Peretti

Micro forceps, angled jaws



MCL340

Jaws 45° - 2mm

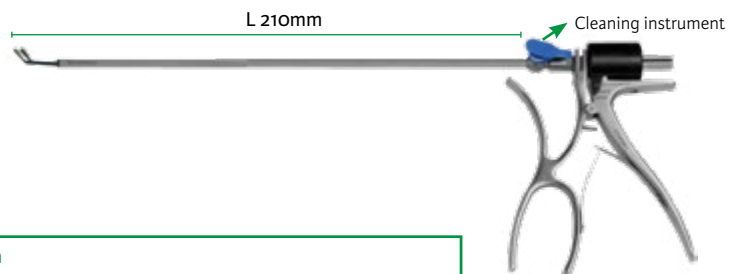

Bipolar cables - 4.5 m



CP393-2

Bowa Emc Lamidey Valleylab



CP393-3

Storz Wolf Erbe (except ICC/VIO international)



CP393-4

Aesculap Berchtold Martin Sutter BM-780 II

Injector, injection needles

Bouchayer

Injection needle
bayonet tip Ø 1mm



MCL55-1



MCL55-2

right



MCL55-3

left

Injection needle, straight
malleable Ø 0.5mm



MCL55U

Pk 6 - Single use
non sterile



L 220mm

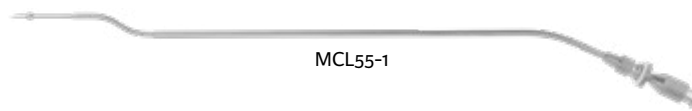

MCL55-1

L 245mm



MCL55U

Scale 1/3

Working length - «L»

Injector

MCL55

with needle MCL55-1

MCL55B

with adapter MCL55R

Luer-lock adapter



MCL55R

Scale 1/1

Transcervical laryngeal injection

Casiano

MCL55T6

MCL55T4

MCL55T5

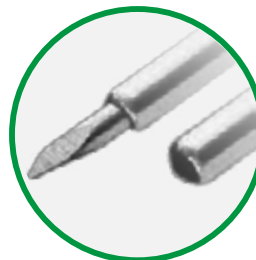

Handle for injection needle

MCL55T4

Trocar obturator

MCL55T6

Injection needle
Ø 0.8mm L 40mm - Pack 6

MCL55T5

non sterile

Scale 1/3

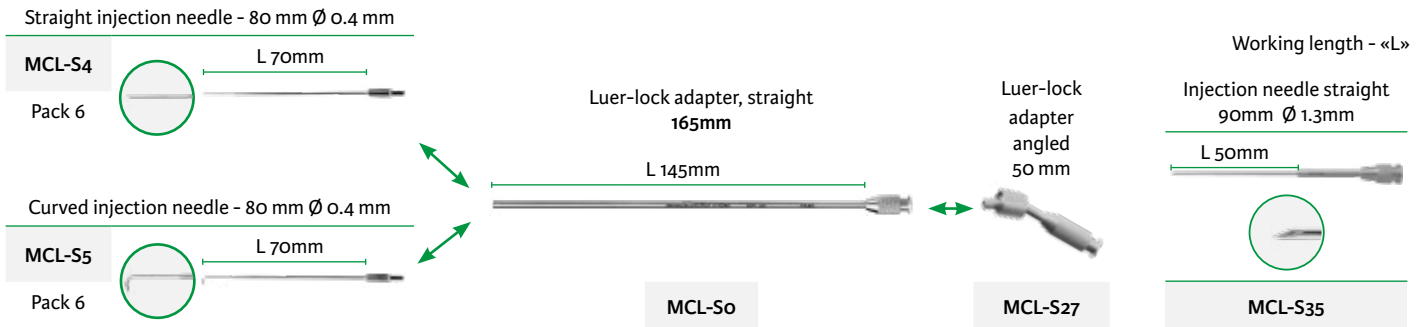

Dismantled instruments for instrument holder MCL-S19

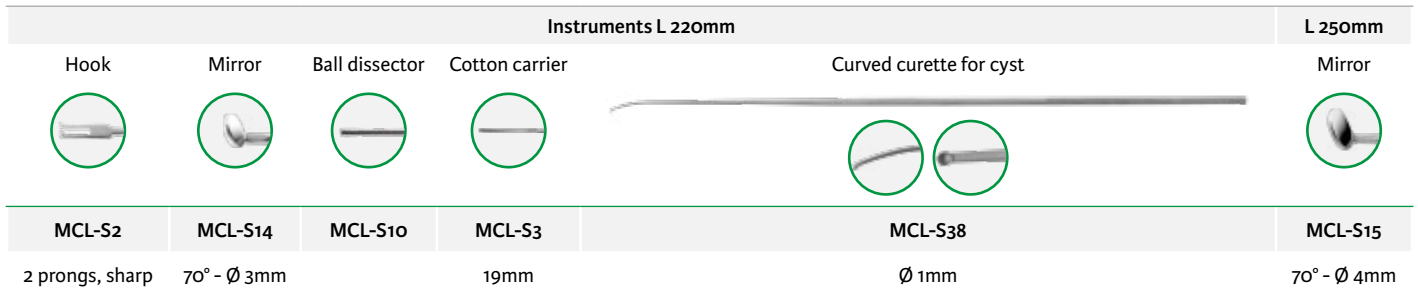
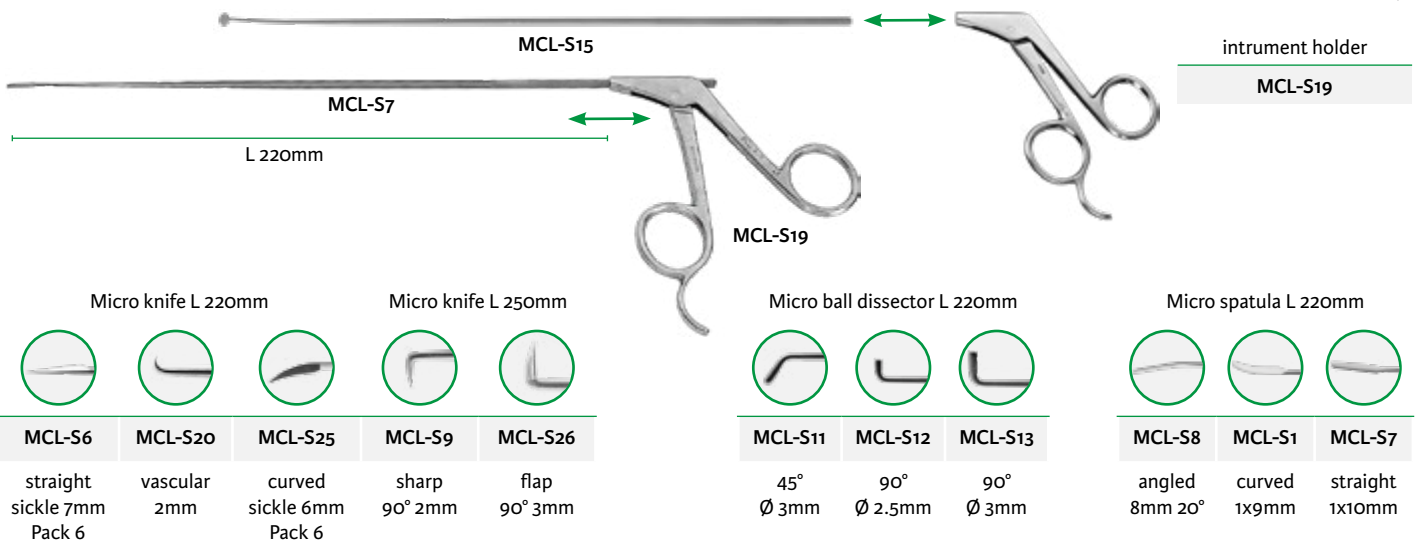

Scale 2/3
Working length - «L»

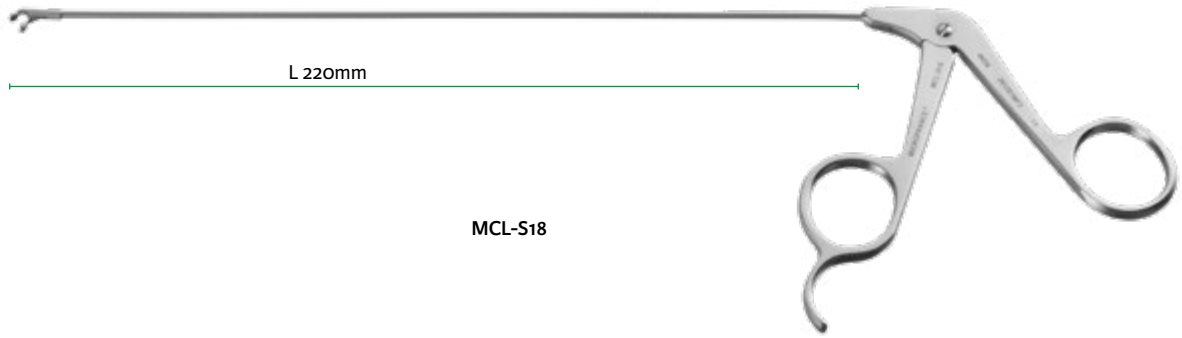

MCL-S18

Cup forceps	Heart-shaped grasper	
MCL-S18 downbiting	MCL-S21 right	MCL-S22 left

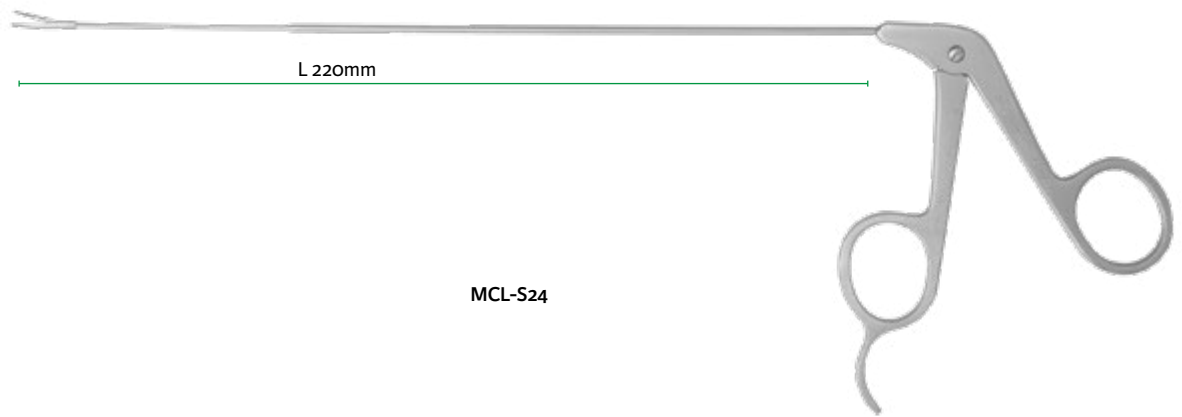

MCL-S24

Alligator forceps			
MCL-S23 right	MCL-S24 left	MCL-S39 fine right jaws	MCL-S41 fine left jaws

Scale 1/3
Working length - «L»

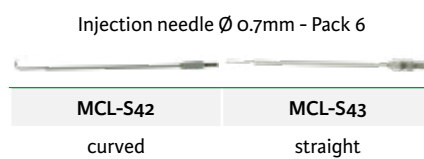
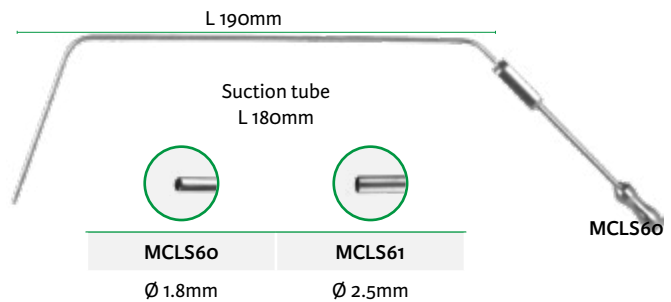
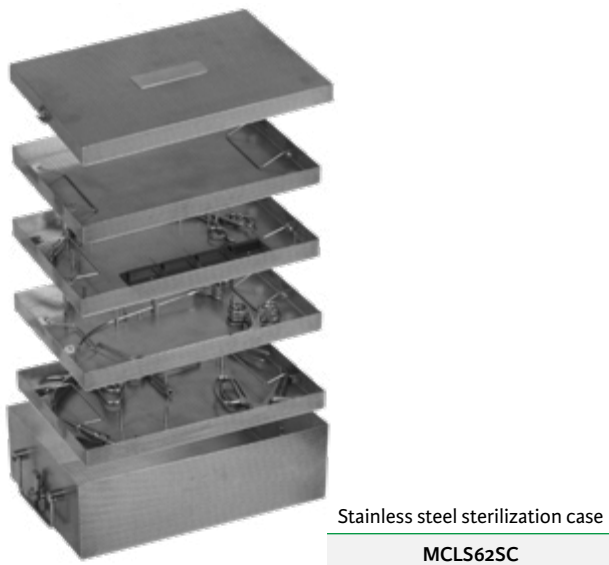
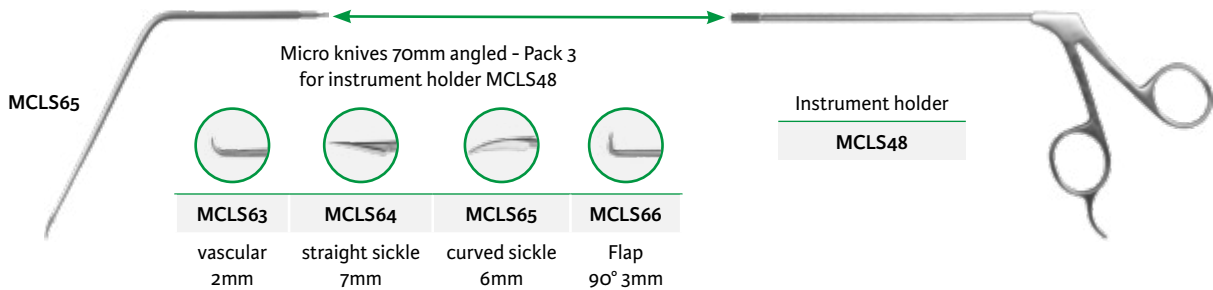
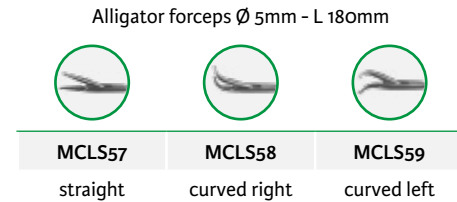
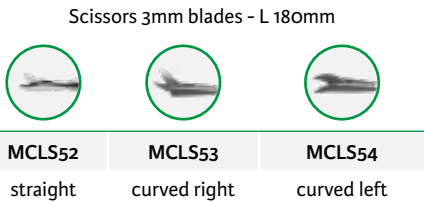
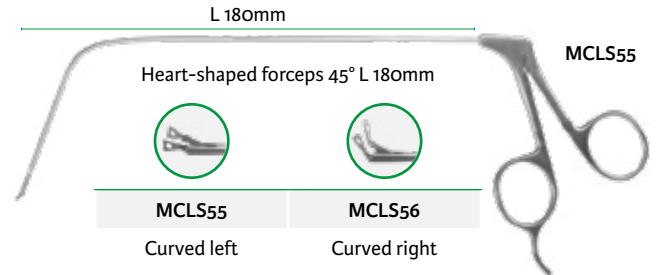
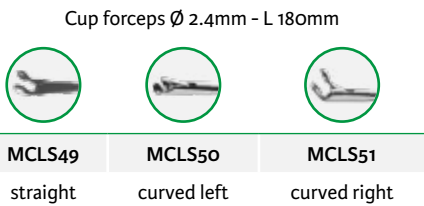
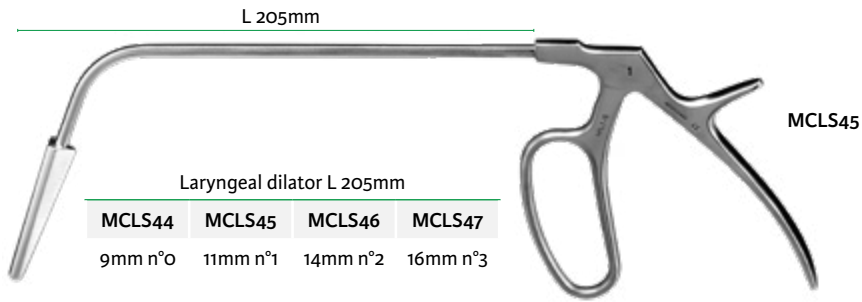

Scale 1/3

Working length 220mm



Micro scissors



MCLB16

curved right

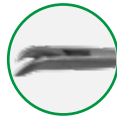

MCLB17

curved left



MCLB31

angled 70°



MCLB31

Cup forceps



MCLS18R

280mm

downbiting



Heart-shaped grasper



MCL-S21R

right



MCL-S22R

left

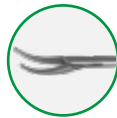

MCL-S23R

right



MCL-S24R

left



MCL-S22R

Needle-driver



MCLB94

280mm

angled up 70°



Suture knot pusher



MCLB30

250mm



Scale 1/2
Working length «L»



Trocar holder ring
Ø 10mm

MCLP70

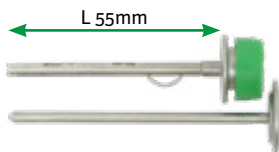

Trocar
with blunt tip

MCLP10

L 55mm

L 180mm



Fenestrated forceps, 3x8mm jaws

MCLP20U

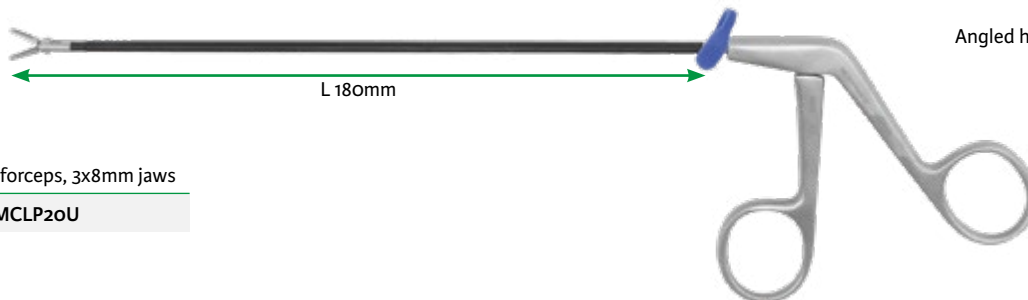

Angled handle



Fenestrated forceps, 3x8mm jaws

MCLP25U



MCLP30U

Axial handle

L 100mm



forceps, alligator jaws, 6mm

MCLP30U



Micro scissors, 4mm blades

MCLP40U

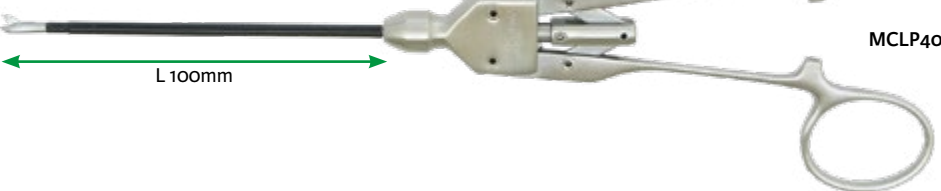

MCLP40U

Axial handle

L 100mm



Monopolar hook

MCLP50



MCLP50

L 100mm







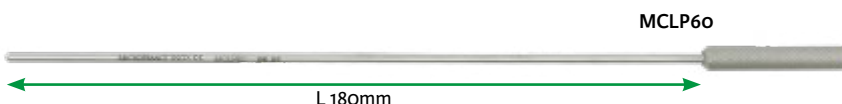

Round palpation probe

MCLP60



MCLP60

L 180mm









		Blunt retractor 180mm
MCLT10	small tips : 8x35 / 15x40mm	
MCLT11	Large tips : 8x35 / 15x50mm	
		Blunt curved elevator 190mm
MCLT20	2mm	
MCLT21	4mm	
		Suction tube elevator 200mm Ø 3mm
MCLT40	Malleable	
		Nerve eye suction tube with finger control 200mm Ø 3mm
MCLT50	Malleable	
		Peanut holder 200mm Ø 3mm axial handle
MCLT30		

Robotic thyroid surgery

MCLT12R	Muscle retractor	
MCLT13R	Bivalve retractor	
MCLT21R	Ball hook elevator Ø 4mm 440mm	
MCLT40R	Suction elevator, malleable, Ø 3mm 270mm	
MCLT50R	Malleable ner eye suction tube, 330mm	

not shown

Trocar with metal cannula



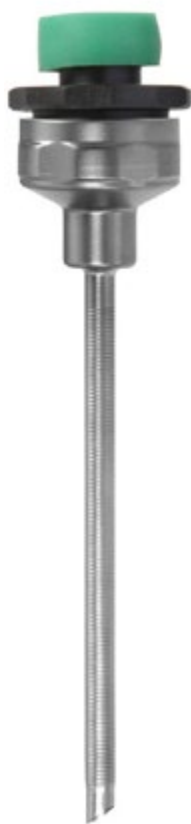



			Working length	
			50 mm	80 mm
Trocar tip	smooth		CEV8143A4	CEV143A4
	pyramidal		CEV8143A3	CEV143A3
Sealing cap	green		CEV103P6 Pack 6	
Trocar head	magnetic		CEV177A3 Delivered complete with 1 magnetic valve and 1 green sealing cap	
	silicone		CEV127T3 Delivered complete with 1 silicone valve and 1 green sealing cap	
Valve for trocar head	magnetic		CEV179A5 Pack 6	
	silicone		CEV125P6 Pack 6	
Metal cannula, crenelated	with stopcock		CEV8143A7	CEV143A7
	without stopcock		CEV8143B7	CEV143B7



Scale 1/1

Composite trocar with silicone valve



			Working length	
			45 mm	70 mm
Trocar tip 	smooth 		CEV8826M (1)	CEV326M (1)
	pyramidal 		CEV8826P (1)	CEV326P (1)
Sealing cap	green 		CEV103P6 Pack 6	
Valve for trocar head	silicone 		CEV125P6 Pack 6	
Trocar body composed of 1 trocar head with composite cannula and silicone valve	smooth cannula without stopcock 		CEV8826L (1)	CEV326L (1)
	threaded cannula without stopcock 		CEV8826V (1)	CEV326V (1)

(1) New reference

Monopolar hook





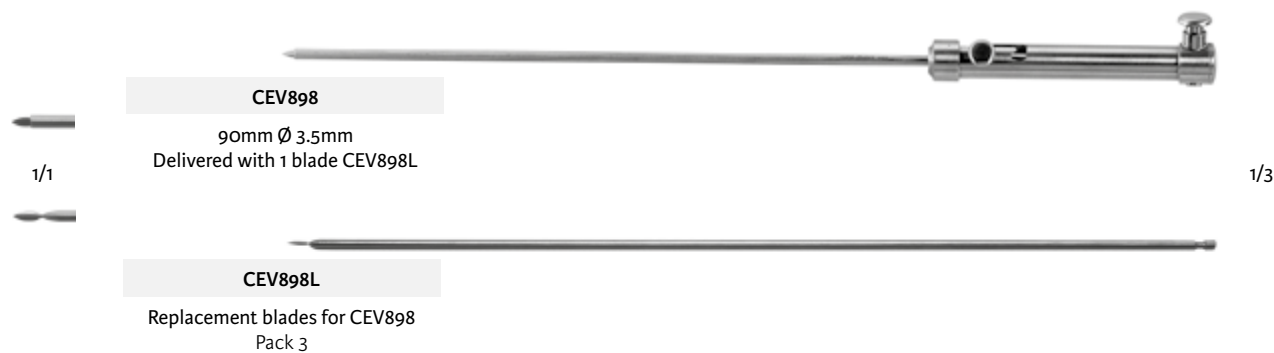



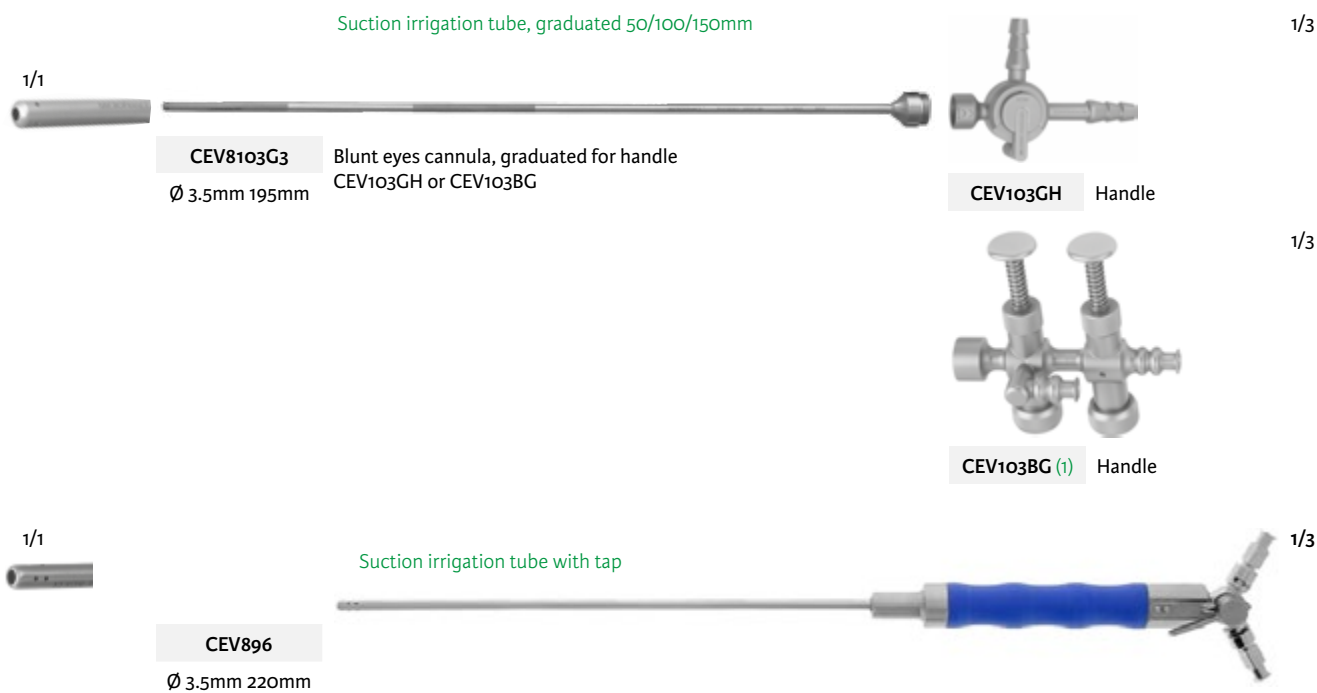

Retractable knife

















Suction irrigation tube



(1) New reference

1-piece			
Complete instruments : bipolar forceps			
Jaws Scale 1/1		Handle	Working length
 serrated jaws, 1,5mm		Angled, bipolar	CEV897 250 mm
			1/3
 fenestrated jaws, 10x3mm		«K» handle, bipolar	CEV897BG 250 mm
			1/3
 spatula jaws, 2mm		«K» handle, bipolar	CEV897C 250 mm
			1/3









Bipolar cables - 4.5 m		
 CP393-2	 CP393-3	 CP393-4
Bowa Emc Lamidey Valleylab	Storz Wolf Erbe (except ICC/VIO international)	Aesculap Berchtold Martin Sutter BM-780 II

Semi-Modular		
Inserts with tubes		Handle
Jaws with insulated tube Scale 1/1	Working length	Pages
 Babcock insert	CEV891IU 235 mm	   Rotatable page 82-83
 Curved scissors insert serrated blades 8mm	CEV893IU 230 mm	
 Straight scissors insert serrated blades 8mm	CEV894IU 230 mm	
 Fenestrated insert 3x12mm jaws	CEV895IU 235 mm	
 Grasping insert	CEV899IU 220 mm <i>New reference</i>	
 Alligator jaws insert 6mm	CEV896IU 235 mm	
 Dissector insert medium curved 10mm jaws	CEV898IU 230 mm	
	CEV39L Adapter cleaning luer-lock for tube insert	

Modular

Rotatable instruments

Angled handles with black rotatable ring
Scale 1/3

 <p>with ratchet</p>	<p>CEV1019T5BU Large pattern</p>  <p>with ratchet</p> <p>CEV10195CU</p>
 <p>with ratchet</p>	<p>CEV10195DU</p>  <p>with ratchet</p> <p>CEV10195RU</p>
 <p>without ratchet</p>	<p>CEV1039T5TBU Large pattern</p>  <p>without ratchet</p> <p>CEV10395DU</p>
 <p>without ratchet</p>	<p>CEV10395RU</p>  <p>without ratchet</p> <p>CEV1039G5U</p>

Modular

Rotatable instruments

Axial handles with black rotatable ring
Scale 1/3



CEV6285R

with ratchet



CEV6385RU

without ratchet



CEV628P5

with ratchet



CEV728T5

with long ratchet

Modular

Rotatable instruments

Ergonomic handles with black rotatable ring
Scale 1/3



Large ergonomic handle
with ratchet

CEV720BRUC



Fine ergonomic handle
with ratchet

CEV720RU











Elhadad
Fine ergonomic handle
with ratchet









CEV7285RU









Large ergonomic handle
with ratchet

CEV728BR5U

1-piece		
Complete instruments		
Jaws Scale 1/1	Handle	Working length
 Montupet Babcock forceps	 Angled with long ratchet	CEV891MU 200 mm
 Montupet Straight scissors serrated blades 8mm	 Angled	CEV894MU 220 mm
 Montupet Fenestrated forceps 3x12mm jaws	 Angled with long ratchet	CEV895MU 195 mm
 Grasping forceps with teeth	 Angled with long ratchet	CEV899U 220 mm New reference

1-piece			
De Lagausie instruments			
Jaws Scale 1/1	Handle		Working length
 De Lagausie Fenestrated forceps 3x12mm jaws	 Axial		CEV995MU 220 mm
 De Lagausie Straight scissors serrated blades 8mm	 Axial		CEV996MU 220 mm
 De Lagausie Alligator forceps 6mm serrated jaws	 Axial		CEV997MU 210 mm
 De Lagausie Dissector medium curved 10mm	 Axial		CEV998MU 220 mm

Needle-holder			
 Montupet Needle-holder straight tungsten jaws	 Angled with long ratchet		CEV892 220 mm
 Reinberg Needle-holder straight tungsten jaws	 Axial		CEV992 220 mm
 Needle-holder left curved tungsten jaws	 Axial		CEV992D 220 mm

Cup



7876-60^(D)

Cup

7876-60 ^(D)	60mm
7876-80 ^(D)	80mm
7876-100 ^(D)	100mm
7876-120 ^(D)	120mm
7876-160 ^(D)	160mm

Stainless steel tray



7872-24^(D)
Scale 1/2

Stainless steel tray

7872-24 ^(D)	240x180mm
------------------------	-----------

Surgical instrument paraffin oil



Surgical instrument
paraffin oil

MCO731 ^(D)

^(D) Distributed by Integra MicroFrance SAS (France) - For corresponding manufacturer part numbers, see table in annex

Scale 1/5

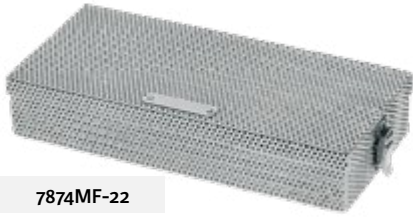

7874MF-22

220x100x40mm

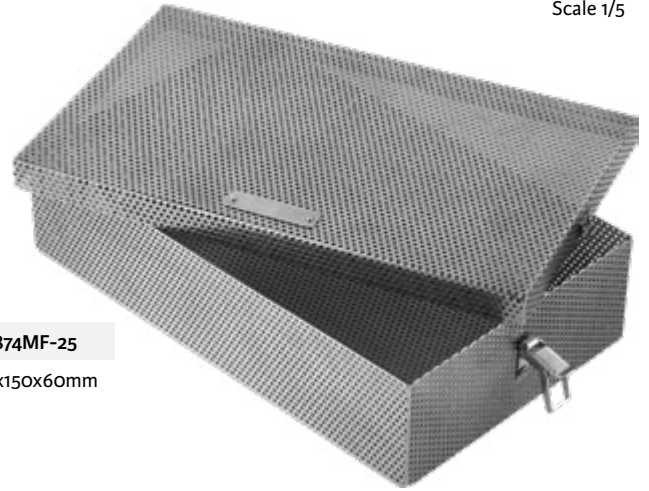

7874MF-25

250x150x60mm

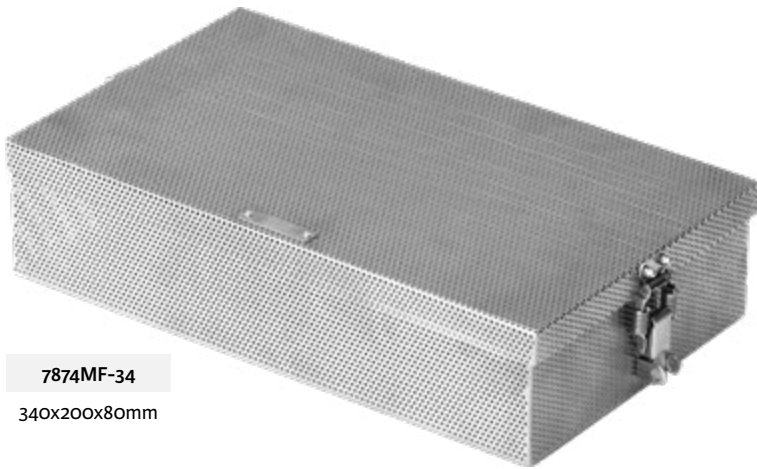

7874MF-34

340x200x80mm

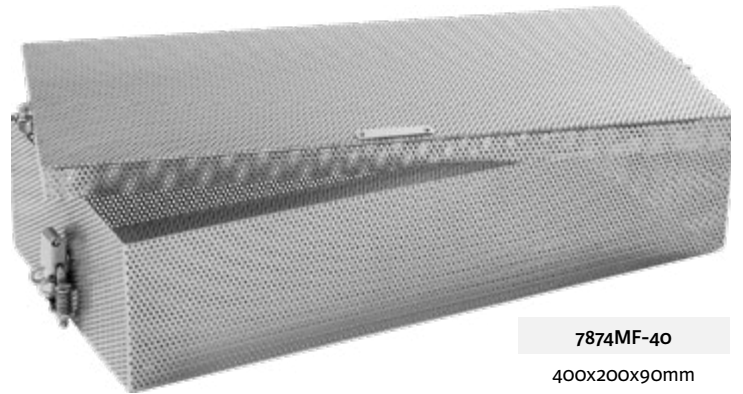

7874MF-40

400x200x90mm

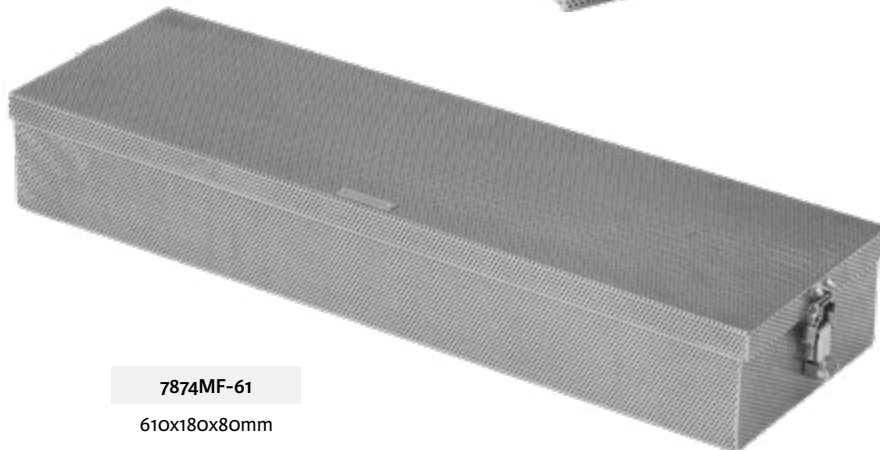

7874MF-61

610x180x80mm

Numerical index

0

0-28-7.....	26
-------------	----

1

1003IG(D).....	21
1003LI(D).....	12, 21
1004IG(D).....	21
1005I(D).....	21

3

3714O27.....	25
3714O28.....	25
3724O59.....	22
3734O42.....	13
3734I15.....	68

7

701T.....	49
702T.....	48
703T.....	48
704T.....	48
714T.....	48
720T.....	49
7755-1-0-4.....	15
7755-1-0-5.....	15
7755-1-0-6.....	15
7768.....	24
7768-1.....	24
7773.....	28
7781.....	27
7782-1-2.....	25
7787-10.....	22
7796.....	2
7797-1.....	10
7797-2.....	10
7798T1(D).....	2
7798T(D).....	2
7800MF.....	10
7802C.....	4
7802P.....	3, 4, 5, 9
7802S-1.....	4
7802S-2.....	4
7802S-3.....	4
7802S-4.....	4
7802S-5.....	4
7803B.....	3
7803C.....	3
7803S-1.....	3
7803S-2.....	3

7803S-3.....	3
7804-9.....	6
7804-11.....	6
7804-13.....	6
7805-11.....	6
7805-13.....	6
7808L-1.....	15
7808L-2.....	15
7808L-3.....	15
7808M.....	15
7809MF.....	6
7810.....	15
7811.....	12
7812.....	12
7813.....	15
7813-1.....	15
7814.....	12
7814M.....	12
7815.....	12
7819.....	11
7820.....	11
7821A.....	6
7821B.....	6
7822.....	11
7823.....	11
7825.....	11
7826-1-7.....	11
7828-1-10.....	14
7828-1-13.....	14
7828-1-16.....	14
7828-1-19.....	14
7828-10.....	14
7828-13.....	14
7828-16.....	14
7828-19.....	14
7829-10.....	14
7829-13.....	14
7829-16.....	14
7829-19.....	14
7830M.....	16
7831A-12.....	37
7831A-15.....	39
7831A-18.....	41
7831A-20.....	42
7832.....	42
7833A-12.....	37
7833A-15.....	39
7833A-18.....	41
7833A-20.....	42
7834.....	42
7835.....	16
7837-18.....	16
7838.....	16

7839.....	16
7840.....	16
7843-1.....	55
7843A-1.....	55
7844T3L20.....	55
7844T3L25.....	55
7844T3L30.....	55
7844T3L35.....	55
7844T3L40.....	54
7844T3L45.....	54
7844T3L50.....	54
7844T3L55.....	54
7844T3L60.....	54
7844T5L20.....	55
7844T5L25.....	55
7844T5L30.....	55
7844T5L35.....	55
7844T5L40.....	54
7844T5L45.....	54
7844T5L50.....	54
7844T5L55.....	54
7844T5L60.....	54
7844T6L20.....	55
7844T6L25.....	55
7844T6L30.....	55
7844T6L35.....	55
7844T6L40.....	54
7844T6L45.....	54
7844T6L50.....	54
7844T6L55.....	54
7844T6L60.....	54
7844T74L20.....	55
7844T74L25.....	55
7844T74L30.....	55
7844T74L35.....	55
7844T74L40.....	54
7844T74L45.....	54
7844T74L50.....	54
7844T74L55.....	54
7844T74L60.....	54
7857.....	10
7866-13.....	53
7867-1.....	50
7867-2.....	50
7867-3.....	50
7867-4.....	50
7872-24(D).....	87
7874MF-22.....	88
7874MF-25.....	88
7874MF-34.....	9, 88
7874MF-40.....	88
7874MF-61.....	54, 88
7876-60(D).....	87

^(D) Distributed by Integra MicroFrance SAS (France) - For corresponding manufacturer part numbers, see table in annex

7876-80(D).....	87
7876-100(D).....	87
7876-120(D).....	87
7876-160(D).....	87
7878.....	12
7879.....	12
7884.....	12
7895.....	12
7920.....	16
7921.....	16
7923.....	29
7945T.....	49
7960T40(D).....	3, 4, 5, 9

CEV

CEV39L.....	81
CEV103BG.....	79
CEV103GH.....	79
CEV103P6.....	77, 78
CEV125P6.....	77, 78
CEV127T3.....	77
CEV143A3.....	77
CEV143A4.....	77
CEV143A7.....	77
CEV143B7.....	77
CEV177A3.....	77
CEV179A5.....	77
CEV326L.....	78
CEV326M.....	78
CEV326P.....	78
CEV326V.....	78
CEV392D20.....	45
CEV392D30.....	45
CEV392G24.....	45
CEV392P20.....	45
CEV392R15.....	45
CEV392S20.....	45
CEV417.....	29
CEV418.....	29
CEV419.....	29
CEV628P5.....	83
CEV720BRUC.....	84
CEV720RU.....	84
CEV728BR5U.....	84
CEV728T5.....	83
CEV890.....	79
CEV890C.....	79
CEV891MU.....	85
CEV892.....	86
CEV894MU.....	85
CEV895MU.....	85
CEV896.....	79

CEV897.....	80
CEV897BG.....	80
CEV897C.....	80
CEV898.....	79
CEV898L.....	79
CEV899U.....	85
CEV984.....	57
CEV992.....	86
CEV992D.....	86
CEV995MU.....	86
CEV996MU.....	86
CEV997MU.....	86
CEV998MU.....	86
CEV1019T5BU.....	82
CEV1039G5U.....	82
CEV1039T5TBU.....	82
CEV6285R.....	83
CEV6385RU.....	83
CEV7285RU.....	84
CEV8103G3.....	79
CEV8143A3.....	77
CEV8143A4.....	77
CEV8143A7.....	77
CEV8143B7.....	77
CEV8826L.....	78
CEV8826M.....	78
CEV8826P.....	78
CEV8826V.....	78
CEV10195CU.....	82
CEV10195DU.....	82
CEV10195RU.....	82
CEV10395DU.....	82
CEV10395RU.....	82

CP

CP16.....	30
CP16-1.....	30
CP17.....	24
CP17-1.....	24
CP17-2.....	24
CP17-3.....	24
CP21-3.....	25
CP21A-3.....	25
CP37.....	37
CP310.....	23
CP310D.....	23
CP310E.....	23
CP330-3-0.....	19
CP330-4-0.....	19
CP332.....	37
CP335.....	25
CP335P.....	29

CP344A.....	23
CP344AT.....	23
CP344B.....	23
CP344BT.....	23
CP344C.....	23
CP344CT.....	23
CP344D.....	23
CP344DT.....	23
CP344E.....	23
CP344ET.....	23
CP345.....	40
CP351-1.....	35
CP351-2.....	34
CP351-3.....	34
CP351-5.....	35
CP351-6.....	34
CP351-7.....	34
CP352.....	36
CP352-1.....	36
CP352-2.....	36
CP352-3.....	36
CP353.....	30
CP354.....	30
CP354A.....	30
CP355.....	31
CP355A.....	31
CP355C.....	33
CP356.....	30
CP358.....	30
CP358A.....	30
CP362.....	31
CP363.....	32
CP365.....	33
CP367.....	31
CP367-1.....	31
CP390-1.....	47
CP390-2.....	47
CP390-3.....	46
CP390-5.....	46
CP390-7.....	46
CP390-8.....	47
CP390L26.....	46
CP391E.....	12, 46, 47, 66, 69
CP391M.....	12, 46, 47, 66, 69
CP391V.....	12, 46, 47, 66, 69
CP392-1R.....	43
CP392-2R.....	43
CP392-3R.....	44
CP392-5R.....	44
CP392-8R.....	43
CP392-9R.....	44
CP392-10R.....	44
CP392BI.....	43

^(D) Distributed by Integra MicroFrance SAS (France) - For corresponding manufacturer part numbers, see table in annex

CP392BS.....	43
CP393-2.....	43, 44, 45, 69, 80
CP393-3.....	43, 44, 45, 69, 80
CP393-4.....	43, 44, 45, 69, 80
CP400.....	39
CP400-1.....	37
CP400-2.....	41
CP401.....	40
CP406.....	37
CP407.....	39
CP409.....	41
CP414.....	37
CP415.....	39
CP604.....	38
CP604-15.....	38
CP604BR.....	43
CP604M.....	47
CP605.....	38
CP605-15.....	38
CP605BR.....	43
CP605M.....	47
CP606.....	38
CP606-15.....	38
CP606A.....	38
CP609.....	25
CP611.....	20
CP616-13.....	33
CP616-15.....	33
CP625.....	20
CP626.....	20
CP627.....	20
CP628.....	24
CP637.....	32
CP818-8.....	28
CP818-10.....	28
CP818-12.....	28
CP818-15.....	28
CP818-20.....	28
CP821.....	21
CP821E.....	67
CP822-10.....	24
CP822-12.....	24
CP822-14.....	24
CP825.....	22
CP919.....	30
CP919A.....	30
CP921.....	33
CP922.....	32
CP922A.....	32
CP922B.....	32
CP931.....	34
CP931-1.....	34
CP931-3.....	35
CP931-5.....	35

CP933-14.....	39
CP933-16.....	40
CP933-18.....	41
CP934.....	39
CP934-1.....	39
CP936.....	40
CP938-1.....	37
CP941.....	24
CP984.....	28
CP984-1.....	28
CP985.....	20
CP988-15.....	39
CP988-18.....	41
CP988-20.....	42
CP997.....	31
CP1107.....	48

MCL37D.....	58
MCL37DF.....	58
MCL37G.....	58
MCL38N(D).....	9, 57
MCL42.....	58
MCL46.....	60
MCL46A.....	60
MCL47.....	60
MCL48.....	67
MCL49.....	56
MCL49F.....	56
MCL51.....	58
MCL52.....	58
MCL53.....	58
MCL54.....	58
MCL55.....	70
MCL55-1.....	70
MCL55-2.....	70
MCL55-3.....	70
MCL55B.....	70
MCL55R.....	70
MCL55T4.....	70
MCL55T5.....	70
MCL55T6.....	70
MCL55U.....	70
MCL56BL.....	64
MCL56BR.....	64
MCL56PL.....	65
MCL56PR.....	65
MCL57.....	64
MCL58.....	68
MCL59.....	69
MCL62.....	69
MCL63.....	59
MCL63F.....	59
MCL64.....	59
MCL64F.....	59
MCL65A.....	60
MCL65AF.....	60
MCL65AS.....	60
MCL67.....	63
MCL68.....	63
MCL69.....	63
MCL75.....	57
MCL76.....	9, 57
MCL77.....	59
MCL78.....	59
MCL79.....	59
MCL81BL.....	64
MCL81BR.....	64
MCL81PL.....	65
MCL81PR.....	65
MCL82.....	64
MCL83.....	60

M

M832.....	38
M833.....	38

MCEN

MCEN39L.....	65, 67
MCEN770J30.....	19
MCEN770J40.....	19

MCL

MCL1BIS.....	67
MCL4.....	67
MCL5.....	67
MCL7.....	67
MCL10.....	62
MCL11.....	64
MCL12.....	63
MCL15.....	63
MCL16.....	64
MCL17.....	64
MCL18.....	63
MCL19.....	63
MCL19BIS.....	63
MCL25.....	63
MCL29.....	63
MCL30.....	63
MCL31.....	64
MCL33.....	63
MCL34.....	69
MCL35.....	9, 57
MCL37.....	58
MCL37C.....	58
MCL37CF.....	58

MCL83-1.....	60
MCL84.....	60
MCL88.....	56
MCL88-1.....	56
MCL88-2.....	56
MCL89.....	60
MCL89-1.....	9, 56, 60
MCL89-2.....	9, 60
MCL93.....	64
MCL93-2.....	64
MCL94.....	64
MCL94G.....	67
MCL94IG.....	67
MCL94IP.....	65
MCL94IPR.....	65
MCL98.....	68
MCL100.....	9, 62
MCL100T15.....	62
MCL100T20.....	62
MCL101.....	68
MCL102.....	68
MCL103.....	62
MCL110.....	55
MCL111.....	55
MCL112.....	55
MCL112F.....	55
MCL112H.....	54, 55
MCL120.....	61
MCL121.....	61
MCL122.....	61
MCL123.....	61
MCL124.....	61
MCL124FL.....	61
MCL124FR.....	61
MCL124ST.....	61
MCL125.....	61
MCL125FL.....	61
MCL125FR.....	61
MCL125ST.....	61
MCL170(D)(1).....	9, 57
MCL171(D)(1).....	9, 57
MCL173(D)(1).....	9, 57
MCL174(D)(1).....	9, 57
MCL197(D)(1).....	9, 57
MCL200.....	5
MCL201.....	5
MCL205.....	66
MCL206.....	8
MCL206A1.....	7, 8
MCL206A2.....	8
MCL206A3.....	8
MCL206A4.....	8

MCL206A5.....	8
MCL206A6.....	8
MCL206A7.....	8
MCL206C.....	7, 8
MCL206K.....	8
MCL206P.....	7, 8
MCL210.....	62, 66
MCL219.....	66
MCL219-1.....	66
MCL241.....	66
MCL241-1.....	66
MCL290.....	60
MCL291.....	60
MCL291AD.....	60
MCL291AG.....	60
MCL291FD.....	60
MCL291FG.....	60
MCL294.....	60
MCL295.....	60
MCL320.....	54
MCL320F.....	54
MCL330.....	54
MCL330F.....	54
MCL340.....	69
MCL359.....	27
MCL828.....	65
MCL828C.....	67
MCL920L25.....	55
MCL920L30.....	56
MCL920L35.....	55
MCL920L45.....	54
MCL920L55.....	54
MCL925L25.....	55
MCL925L30.....	56
MCL925L35.....	55
MCL925L45.....	54
MCL925L55.....	54
MCL930L25.....	55
MCL930L30.....	56
MCL930L35.....	55
MCL930L45.....	54
MCL930L55.....	54
MCL935L25.....	55
MCL935L30.....	56
MCL935L35.....	55
MCL935L45.....	54
MCL935L55.....	54
MCL940L25.....	55
MCL940L30.....	56
MCL940L35.....	55
MCL940L45.....	54
MCL940L55.....	54

MCLB

MCLB16.....	74
MCLB17.....	74
MCLB30.....	74
MCLB31.....	74
MCLB94.....	74

MCLP

MCLP10.....	75
MCLP20U.....	75
MCLP25U.....	75
MCLP30U.....	75
MCLP40U.....	75
MCLP50.....	75
MCLP60.....	75
MCLP70.....	75

MCL-S

MCL-S0.....	71
MCL-S1.....	71
MCL-S2.....	71
MCL-S3.....	71
MCL-S4.....	71
MCL-S5.....	71
MCL-S6.....	71
MCL-S7.....	71
MCL-S8.....	71
MCL-S9.....	71
MCL-S10.....	71
MCL-S11.....	71
MCL-S12.....	71
MCL-S13.....	71
MCL-S14.....	71
MCL-S15.....	71
MCL-S16.....	62
MCL-S17.....	62
MCL-S17-1.....	62
MCL-S18.....	72
MCL-S18R.....	74
MCL-S19.....	71
MCL-S20.....	71
MCL-S21.....	72
MCL-S21R.....	74
MCL-S22.....	72
MCL-S22R.....	74
MCL-S23.....	72
MCL-S23R.....	74
MCL-S24.....	72
MCL-S24R.....	74

⁽¹⁾ Not a medical product

⁽²⁾ Distributed by Integra MicroFrance SAS (France) - For corresponding manufacturer part numbers, see table in annex

MCL-S25.....	71
MCL-S26.....	71
MCL-S27.....	71
MCL-S35.....	71
MCL-S38.....	71
MCL-S39.....	72
MCL-S41.....	72
MCL-S42.....	73
MCL-S43.....	73
MCLS44.....	73
MCLS45.....	73
MCLS46.....	73
MCLS47.....	73
MCLS48.....	73
MCLS49.....	73
MCLS50.....	73
MCLS51.....	73
MCLS52.....	73
MCLS53.....	73
MCLS54.....	73
MCLS55.....	73
MCLS56.....	73
MCLS57.....	73
MCLS58.....	73
MCLS59.....	73
MCLS60.....	73
MCLS61.....	73
MCLS62SC.....	73
MCLS63.....	73
MCLS64.....	73
MCLS65.....	73
MCLS66.....	73
MCLS120-1.....	61
MCLS120-2.....	61
MCLS120-3.....	61
MCLS121-1.....	61
MCLS121-2.....	61
MCLS121-3.....	61
MCLS122-1.....	61
MCLS122-2.....	61
MCLS122-3.....	61
MCLS123-1.....	61
MCLS123-2.....	61
MCLS1233.....	61

MCLT

MCLT10.....	76
MCLT11.....	76
MCLT12R.....	76
MCLT13R.....	76
MCLT20.....	76

MCLT21.....	76
MCLT21R.....	76
MCLT30.....	76
MCLT40.....	76
MCLT40R.....	76
MCLT50.....	76
MCLT50R.....	76

MCLW

MCLW10.....	68
MCLW11.....	68

MCM

MCM1R.....	18
MCM4BISR.....	17
MCM4R.....	17
MCM7BISR.....	18
MCM7R.....	18
MCM10-0-5.....	17
MCM10-1-0.....	17
MCM12R.....	18
MCM13.....	17
MCM13-1.....	17
MCM25-3.....	9, 18
MCM970.....	18
MCM973D3.....	17
MCM973D5.....	17

MCO

MCO201-2-5.....	19
MCO201-3-0.....	19
MCO305.....	20
MCO731(D).....	87
MCO770-1-5.....	19
MCO770-2-0.....	19
MCO770-2-5.....	19
MCO770-3-0.....	19
MCO770-3-5.....	19
MCO770-4-0.....	19
MCO771-2-5.....	19
MCO771-3-0.....	19
MCO771-4-0.....	19
MCO803.....	20
MCO979.....	22
MCO988.....	22

MCR

MCR2A.....	3
MCR3A.....	3

P

P761-7.....	50
P761-8.....	50
P762-2.....	51
P762-4.....	51
P763.....	52
P764-1.....	51
P764-3.....	51
P764-5.....	51
P764-7.....	51
P764-11.....	51
P765-14.....	52
P765-16.....	52
P769.....	52
P770.....	53
P771.....	53

S

SM63(D).....	67
SM64(D).....	67
SM65(D).....	67

^(D) Distributed by Integra MicroFrance SAS (France) - For corresponding manufacturer part numbers, see table in annex

**Table for corresponding
manufacturer part numbers
For information purposes only**

Integra MicroFrance® product reference	Corresponding manufacturer part number
1003IG	M3IG
1003LI	M3LI
1004IG	M4IG
1005I	M5I
7798T	101
7798T1	101 B
7872-24	1224
7876-100	310
7876-120	312
7876-160	316
7876-60	306
7876-80	308
7960T40	731901
MCL170 ⁽¹⁾	CO101
MCL171 ⁽¹⁾	CO201
MCL173 ⁽¹⁾	CO100
MCL174 ⁽¹⁾	CO200
MCL197 ⁽¹⁾	CO103
MCL38N	EC-BLU50U090
MCO731	430490
SM63	SM63
SM64	SM64
SM65	SM65

⁽¹⁾ Not a medical device

Integra® MicroFrance®

Integra ENT - Throat catalogue

Manufacturers :



Integra MicroFrance SAS (France)
Le Pavillon ■ 03160 Saint Aubin le Monial ■ France



Swann Morton Ltd
Penn Works ■ Owlerton Green ■ Sheffield
South Yorkshire S6 2BJ ■ Royaume Uni

Manufacturers with CE Class I products only :



Agencinox
Zone Industrielle
89110 Aillant sur Tholon ■ France



Chemische Fabrik Dr. Weigert GmbH & Co.
Mühlenhagen
D-20539 Hamburg ■ Allemagne



Moria S.A.
15, rue Georges Besse
92160 Antony ■ France



Directa AB
Box 723
19427 Upplands Vasby ■ Suède



Sunoptic Technologies
6018 Bowdendale Avenue
Jacksonville 32216 ■ Florida USA



RMS - UK Limited
28 Trinity Road ■ Nailsea
Somerset BS48 4NU ■ Royaume Uni

Availability of these products might vary from a given country or region to another, as a result of specific local regulatory approval or clearance requirements for sale in such country or region.

- Consult product labels and inserts for any indications, contraindications, hazards, warnings, precautions, and instructions for use.
- Non contractual document. The manufacturer reserves the right, without prior notice, to modify the products in order to improve their quality.
- Warning: Applicable laws restrict these products to sale by or on the order of a physician.

Additional information for EMEA Customers only :

Products mentioned in this document are CE class I, Is, IIa or IIb devices. Contact Integra should you need any additional information on devices classification. All the medical devices mentioned on this document are CE marked according to European council directive 93/42/EEC on medical devices and its relatives. References that are not medical devices are identified with the indication "NOT A MEDICAL DEVICE".

Products marked with the symbol ^(®) are distributed by Integra MicroFrance SAS (France)

Date of last révision : 11/2020

For more information, please contact customer service :

Europe, Middle-East, Africa

International: +33 (0) 437 47 59 50 ■ +33 (0) 437 47 59 25 (Fax) ■ csemea@integralife.com
France: +33 (0) 437 47 59 10 ■ +33 (0) 437 47 59 29 (Fax) ■ custservfrance@integralife.com
United Kingdom: +44 (0) 1264 312 725 ■ +44 (0) 1264 312 821 (Fax) ■ custsvcs.uk@integralife.com
Belgium & Luxembourg: +32 (0)2 257 4130 ■ +32 (0)2 253 2466 (Fax) ■ custsvcbenelux@integralife.com
Netherlands: +31(0) 852 083 167 ■ +31(0) 207 093 627 (Fax) ■ custsvcnetherlands@integralife.com
Italy: +39 (0)2 577 8921 ■ +39 (0)2 575 113 71 (Fax) ■ custsvitaly@integralife.com
integralife.eu/contact

Integra and the Integra logo are registered trademarks of Integra LifeSciences Corporation or its subsidiaries in the United States and/or other countries.

MicroFrance is a trademark of Integra LifeSciences Corporation or its subsidiaries.

All other trademarks and product names are the property of their respective owners.

© 2020 Integra LifeSciences Corporation. All rights reserved.

0335699-4-EN

DOCUMENT FOR USE IN EUROPE, MIDDLE-EAST AND AFRICA ONLY.